

2020  
IOWA GREEN STREETS CRITERIA

*For Projects Funded 2018 and After*

*updated February 2020*

## ACKNOWLEDGMENTS

The Iowa Economic Development Authority thanks the following individuals and organizations for their assistance in improving and updating the Iowa Green Streets.

Mark LaCroix  
*KCL Engineering*

Stormy Shanks  
*KCL Engineering*

Bill McAnally  
*McAnally Consulting*

Erin Wiggins  
*The Element Group*

Kevin Nordmeyer  
*BNIM*

David Yocca  
*Conservation Design Forum*

The Iowa Economic Development Authority thanks Enterprise Community Partners for providing the Enterprise Green Communities Criteria as the foundation of the Iowa Green Streets Criteria. In addition, thank you to the U.S. Department of Energy, Building Science Corporation and Southface for being “go to” resources for quality building science based research and resources.

# 2020 IOWA GREEN STREETS CRITERIA

## CONTENTS

### INTRODUCTION 1

### 2017 IOWA GREEN STREETS CRITERIA QUICK REFERENCE 5

#### 1. INTEGRATIVE DESIGN 17

- 1.1a Goal Setting 18
- 1.1b Criteria Documentation 21
- 1.2a Resident Health and Well-Being: Design for Health 24
- 1.2b Resident / Occupant Health and Well-Being: Health Action Plan 29
- 1.3a Resilient Communities: Design for Resilience 35
- 1.3b Resilient Communities: Multi-Hazard Risk / Vulnerability Assessment 37

#### 2. LOCATION + NEIGHBORHOOD FABRIC 39

- 2.1 Sensitive Site Protection 40
- 2.2 Connections to Existing Development and Infrastructure 41
- 2.3 Compact Development 42
- 2.4 Compact Development 43
- 2.5 Proximity to Services 43
- 2.6 Preservation of and Access to Open Space for Rural / Tribal / Small Towns 45
- 2.7 Preservation of and Access to Open Space 46
- 2.8 Access to Public Transportation 46
- 2.9 Improving Connectivity to the Community 47
- 2.10 Passive Solar Heating/Cooling 49
- 2.11 Grayfield or Brownfield Site or Adaptive Reuse Building 51
- 2.12 Access to Fresh, Local Foods 52
- 2.13 LEED for Neighborhood Development Certification 54

#### 3. SITE IMPROVEMENTS 56

- 3.1 Environmental Remediation 57
- 3.2 Erosion and Sedimentation Control 58
- 3.3 Low-Impact Development 59
- 3.4 Landscaping 60
- 3.5 Surface Stormwater Management 61
- 3.6 Reducing Heat-Island Effect: Paving 63

#### 4. WATER CONSERVATION 64

- 4.1 Water-Conserving Fixtures 65
- 4.2 Advanced Water Conservation 66
- 4.3 Leaks and Water Metering 68
- 4.4 Efficient Plumbing Layout and Design 69
- 4.5 Water Reuse 70
- 4.6 No Irrigation and Water Reuse if Irrigation is Utilized 71

---

## **5. ENERGY EFFICIENCY 73**

- 5.1 Building Performance Requirements **74**
- 5.1a Building Performance Standard **84**
- 5.1b Building Performance Standard **86**
- 5.1c Building Performance Standard **88**
- 5.1d Building Performance Standard **90**
- 5.1e Building Performance Standard **91**
- 5.2a Additional Reductions in Energy Use **93**
- 5.2b Advanced Certification: Nearing Net Zero **94**
- 5.3 Sizing of Heating and Cooling Equipment **95**
- 5.4 ENERGY STAR Appliances **96**
- 5.5 Lighting **96**
- 5.6 Electricity Meter **98**
- 5.7a Photovoltaic/Solar Hot Water Ready **98**
- 5.7b Renewable Energy **100**
- 5.8a Resilient Energy Systems: Floodproofing **101**
- 5.8b Resilient Energy Systems: Islandable Power **102**
- 5.9 Advanced Framing (Optimum Value Engineering) **104**
- 5.10 Advanced Metering Infrastructure **106**

## **6. MATERIALS 107**

- 6.1 Low/ No VOC Paints, Coatings and Primers **108**
- 6.2 Low/ No VOC Adhesives and Sealants **109**
- 6.3 Recycled Content Material **110**
- 6.4 Regional Materials **111**
- 6.5 Certified, Salvaged and Engineered Wood Products **112**
- 6.6 Composite Wood Products that Emit Low/No Formaldehyde **112**
- 6.7a Environmentally Preferable Flooring **113**
- 6.7b Environmentally Preferable Flooring: Throughout Building **114**
- 6.8 Mold Prevention: Surfaces **115**
- 6.9 Mold Prevention: Tub and Shower Enclosures **116**
- 6.10 Asthmagen-Free Materials **117**
- 6.11 Reduced Heat-Island Effect: Roofing **118**
- 6.12 Construction Waste Management **119**
- 6.13 Recycling Storage **121**

---

## **7. HEALTHY LIVING ENVIRONMENT 123**

- 7.1 Ventilation **124**
- 7.2 Clothes Dryer Exhaust **126**
- 7.3 Combustion Equipment **127**
- 7.4 Elimination of Combustion Within the Conditioned Space **128**
- 7.5 Vapor Retarder Strategies **129**
- 7.6 Water Drainage **130**
- 7.7 Mold Prevention: Water Heaters **132**
- 7.8 Radon Mitigation **133**
- 7.9 Garage Isolation **136**
- 7.10 Integrated Pest Management **137**
- 7.11a Beyond ADA: Universal Design — New Construction **138**
- 7.11b Beyond ADA: Universal Design — Substantial and Moderate Rehab **139**
- 7.12 Active Design: Promoting Physical Activity Within the Building **140**
- 7.13 Active Design: Staircases and Building Circulation **141**
- 7.14 Interior and Outdoor Activity Spaces for Children and Adults **142**
- 7.15 Smoke-Free Building **143**

## **8. OPERATIONS, MAINTENANCE + OCCUPANT ENGAGEMENT 144**

- 8.1 Building Operations & Maintenance (O&M) Manual and Plan **145**
- 8.2 Emergency Management Manual **148**
- 8.3 Occupant Manual **149**
- 8.4 Occupant and Property Staff Orientation **151**
- 8.5 Project Data Collection and Monitoring System:  
100% Non-Residential, 15%-50% Residential / Mixed-Use Units **152**

Appendix A: Green Development Plan and Checklist

Appendix B: Certification of Intent to Comply

Appendix C: Certification of Construction Document Compliance

Appendix D: Certification of Compliance at End of Construction

Appendix E: Energy Performance Certification

Appendix F: Project Plan and Spec Book Checklist

Appendix G: Air Sealing Key Points

Appendix H Integrated Design Agenda and Outcomes Template

Appendix I: Stormwater Management Milestone Checklist

Appendix J: Glossary

## INTRODUCTION

The Iowa Green Streets Criteria promote public health, energy efficiency, water conservation, smart locations, operational savings and sustainable building practices. The strategies in the following pages enhance affordable housing, community facilities, town centers and communities as a whole.

2018 marks the tenth anniversary of the Iowa Green Streets Criteria. In the last ten years, the criteria have influenced the performance of thousands of residences and numerous community facility and Main Street projects across Iowa. This edition of the Iowa Green Streets Criteria builds on lessons learned the last 10 years and from the growing body of building science research and demonstration projects.

In 2016, the Iowa Economic Development Authority (IEDA) received a National Disaster Resilience Competition grant from HUD and the Rockefeller Foundation. Also in 2016, the Iowa Economic Development Authority, Iowa Department of Public Health, and Iowa Department of Transportation joined with partners and America Walks to host a walkable communities collaborative workshop to identify opportunities for state agencies to more strongly support community walkability.

In support of Iowa's resiliency and walkable communities efforts, the IEDA is following the lead of Enterprise's Green Communities Criteria and incorporating specific community resiliency and active living focused criterion into the Iowa Green Streets Criteria for the first time.

## HOW TO USE THIS DOCUMENT

All mandatory Iowa Green Streets Criteria are required for both residential and non-residential applications. However, there are certain criteria that are not applicable to or are different for non-residential applications. Therefore, certain criterion include different requirements for residential versus non-residential projects.

This Iowa Green Streets Criteria document is subject to periodic revision and update. Refer to the IEDA's Community Development Division website, [iowaeconomicdevelopment.com/community](http://iowaeconomicdevelopment.com/community) for updates.

The mandatory criteria referenced in this document are based on the national Green Communities Criteria as of August 2017. Any revisions to the national Green Communities Criteria will not apply to Iowa Economic Development Authority projects unless adopted by the Iowa Economic Development Authority and specifically addressed in the Iowa Green Streets Criteria.

## ACTIVITIES AND PROJECTS COVERED BY THE IOWA GREEN STREETS CRITERIA

Projects receiving funding from these IEDA programs are required to follow the Iowa Green Streets Criteria.

- Community Development Block Grant Program Community Facilities
- Community Development Block Grant Program Sustainable Community Demonstration
- Community Development Block Grant Program Disaster Recovery (selected projects)
- Main Street Iowa Challenge Grant
- Community Catalyst Remediation Grant
- Multifamily new construction
- Multifamily substantial rehabilitation<sup>1</sup> (see definition below)
- Multifamily moderate rehabilitation<sup>2</sup> (see definition below)
- Single-family new construction

## IOWA GREEN STREETS CRITERIA CATEGORIES

The 2017 Iowa Green Streets Criteria are grouped into the following eight categories:

1. Integrative Design
2. Location + Neighborhood Fabric
3. Site Improvements
4. Water Conservation
5. Energy Efficiency
6. Materials
7. Healthy Living Environment
8. Operations, Maintenance, and Occupant Engagement

## WHY USE THE CRITERIA?

Consider this: 70% of design decisions are made in the first 10% of a project. To maximize time and resources, planning ahead is essential. First, project teams should familiarize themselves with the full Criteria. Then, using a thorough integrative design process, they should consider the goals for the project—and goals for the future residents and occupants —when evaluating which criteria to incorporate into their building(s). Taking a human-centered approach to design and development will lead to a comprehensive planning process and a careful selection of materials and technologies that will better meet project aspirations.

In addition to increasing resource efficiency and reducing environmental impacts, green building strategies can yield cost savings through long-term reduction in operating expenses. The benefits include improved energy performance and comfort, a healthier indoor environment, increased durability of building components, and simplified maintenance requirements that can lead to financial efficiencies for property managers and owners. Green building practices improve the economics of managing affordable housing, community facilities, and Main Street businesses while enhancing quality of life for residents, visitors and employees. When green building practices inform the location of our buildings — placing homes, community facilities and businesses near community amenities such as public transportation to create walkable, livable neighborhoods — the benefits for citizens and communities expand to include fewer sprawl-related transportation impacts.

Guiding principles behind the Iowa Green Streets Criteria ensure that buildings must be cost effective to build, and durable and practical to maintain. In addition, the principles work together to help produce green buildings that:

- Result in a high-quality, healthy living and working environment
- Lower utility costs
- Enhance connections to nature
- Protect the environment by conserving energy, water, materials and other resources
- Advance the health of local and regional ecosystems

Not all of the criteria have directly measurable financial impacts, but these criteria are no less important to meeting a project's mission. Projects will exhibit improved occupant health and well-being through reduced exposure to environmental pollutants, improved connectivity to services and walkable neighborhoods, and good lighting. The benefits extend beyond the occupants to the neighboring community by supporting local community services and activating neighborhood streets, as well as improving water quality and reducing the impact of stormwater run-off on neighboring sewer systems. We suspect that when these benefits are quantified, they will dwarf the energy and water savings benefits we can count today.

Enterprise's project pipeline includes projects that avoid upfront cost premiums when meeting the Enterprise Green Communities Criteria as compared to standard practice after implementing a robust integrative design approach. And overall, the median incremental cost of complying with the Enterprise Green Communities Criteria tends to be minimal: In an evaluation report from 2012, Enterprise found a median 2% increase to total development cost. The average project analyzed in this study achieved lifetime utility savings that exceed the cost of integrating the Enterprise Green Communities Criteria, with a simple payback of 5.59 years.

## DEFINITION OF REHABS

Given that the scope of work on existing buildings can vary widely (from minor repairs to gut rehabs), we have defined two levels of rehabs, to guide project team planning.

*Substantial Rehab* is defined as a project where the work area exceeds 50% of the aggregate area of the building; an International Code Council (ICC) level 3 alteration scope of work.

*Moderate Rehab* is defined as a project where the work area does not exceed 50% of the aggregate area of the building (the work scope is less than an ICC level 3 alteration), yet is still able to comply with the applicable energy performance requirements of Criteria 5.1-5.1e.

While Substantial and Moderate Rehabs are defined as specifically as possible above, each project will most likely have more nuance than can be captured here. Please use these definitions as the start of this guidance, strive for the most inclusive level of integrating the Criteria, and note that compliance with the energy performance requirements of Criterion 5.1 often is the factor that places a project in the New Construction pathway (possible for some gut rehabs), Substantial Rehab pathway or Moderate Rehab pathway. If you are unsure whether your project qualifies as a substantial or moderate rehab project, please contact the IEDA prior to program application at [greenstreets@iowaeda.com](mailto:greenstreets@iowaeda.com).

## QUALITY ASSURANCE AND VERIFICATION

The Iowa Green Streets Criteria verification process is primarily self-driven, with some third-party assistance and verification at key points in the design and construction process. Here is the quality assurance and verification process for projects following the Iowa Green Streets Criteria. NOTE: Not all steps in the process for successfully completing a high-performing building are included here, but many key steps are identified below. Some of the steps could also take place in another order such as steps two and three. Please refer to the full Iowa Green Streets Criteria for more details.

**Step 1:** Notify IEDA that you are planning a project following Iowa Green Streets Criteria (IGS)

**Step 2:** Participate in an optional project design consultation with IEDA

**Step 3:** Conduct an integrated design process (Criterion 1.1a – 1.3b)

**Step 4:** Upload to [www.iowagrants.gov](http://www.iowagrants.gov) completed Appendix A and signed Appendix B with IEDA application

**Step 5:** Hire project design team including HERS rater (all projects) and commissioning agent (commercial projects only) (Criterion 5.1-5.1e)

**Step 6:** Contact [Iowa Department of Agriculture and Land Stewardship](http://www.iowagrants.gov) (IDALS) for stormwater technical assistance (Criterion 3.5)

**Step 7:** Upload signed Appendices C, F, and I to [www.iowagrants.gov](http://www.iowagrants.gov) prior to bidding project

**Step 8:** Conduct contractor and sub-contractor pre-construction meeting to review IGS

**Step 9:** Submit photos of key construction steps installed to [greenstreets@iowaeda.com](mailto:greenstreets@iowaeda.com) (Criterion 5.1a-5.1e)

**Step 10:** Have HERS Rater conduct thermal bypass inspection prior to drywall installation (Criterion 5.1)

**Step 11:** Have HERS Rater and commissioning agent (commercial project only) complete system testing (Criterion 5.1-5.1e)

**Step 12:** Upload signed Appendix D and Appendix E to [www.iowagrants.gov](http://www.iowagrants.gov)

## ATTRIBUTION

To assist project teams in meeting the Iowa Green Streets Criteria performance expectations, many recommendations and resources are provided by IEDA and Enterprise including links to online resources and images of high performance building best practices. Information published by the Building Science Corporation (BSC) on [buildingscience.com](http://buildingscience.com) is protected by copyright under U.S. and International copyright laws and conventions. See [buildingscience.com/editorial-policies-conditions-use](http://buildingscience.com/editorial-policies-conditions-use) for additional information.



## 2017 IOWA GREEN STREETS CRITERIA QUICK REFERENCE

This checklist provides an overview of the technical requirements within the Iowa Green Street Criteria. To achieve Iowa Green Streets Criteria Certification, all projects must achieve compliance with the Criteria mandatory measures applicable to that project type. Additionally, New Construction projects must achieve 35 optional points, Substantial Rehab projects must achieve 30 optional points, and Moderate Rehab projects must also achieve 30 optional points. Projects proposing to achieve a higher quantity of optional points will be scored favorably during the application review process. To assist you in evaluating your project, a fillable form is available here: [iowaeconomicdevelopment.com/userdocs/programs/2017IowaGreenStreetsCriteriaChecklistForm.pdf](http://iowaeconomicdevelopment.com/userdocs/programs/2017IowaGreenStreetsCriteriaChecklistForm.pdf)

**M** = MANDATORY

**#** = OPTIONAL POINTS

### 1. INTEGRATIVE DESIGN

<input type="radio"/> YES <input type="radio"/> NO <input type="radio"/> MAYBE	<b>M</b>	<b>1.1a Goal Setting</b> Develop an integrative design process that works best for your project team and intentions. At minimum, document: <ol style="list-style-type: none"> <li>1. A statement of the overall green development goals of the project and the expected intended outcomes from addressing those goals.</li> <li>2. A summary of the integrative process that was used to select the green building strategies, systems and materials that will be incorporated into the project.</li> <li>3. A description of how progress and success against these goals will be measured throughout the completion of design, construction and operation to ensure that the green features are included and correctly installed.</li> </ol>
<input type="radio"/> YES <input type="radio"/> NO <input type="radio"/> MAYBE	<b>M</b>	<b>1.1b Criteria Documentation</b> Create design and construction documentation to include information on implementation of appropriate Iowa Green Streets Criteria.
<input type="radio"/> YES <input type="radio"/> NO <input type="radio"/> MAYBE	<b>M</b>	<b>1.2a Occupant Health and Well-Being: Design for Health</b> Identify potential occupant health factors and design your project to address resident health and well-being by using the matrix provided in this section.
<input type="radio"/> YES <input type="radio"/> NO <input type="radio"/> MAYBE	<b>12</b>	<b>1.2b Occupant Health and Well-Being: Health Action Plan</b> At pre-design and continuing throughout the project life cycle, collaborate with public health professionals and community stakeholders to assess, identify, implement and monitor achievable actions to enhance health-promoting features of the project and minimize features that could present health risks. Specifically, create a Health Action Plan and integrate the selected interventions and a plan for monitoring and evaluating progress per the full criterion.
<input type="radio"/> YES <input type="radio"/> NO <input type="radio"/> MAYBE	<b>M</b>	<b>1.3a Resilient Communities: Design for Resilience</b> <i>(New Construction and Substantial Rehab only)</i> Given your project building type, location and expected resident population, identify a project characteristic that would most likely impact your project's ability to withstand an unexpected weather event or loss of power. Select at least one criterion from the given list that would help mitigate that impact, and incorporate this within your project plans and design. Include a short narrative providing your rationale for selecting this criterion above the others.



**M** = MANDATORY  
**#** = OPTIONAL POINTS

**INTEGRATIVE DESIGN (continued)**

<input type="radio"/> YES <input type="radio"/> NO <input type="radio"/> MAYBE	<b>15</b>	<b>1.3b Resilient Communities: Multi-Hazard Risk / Vulnerability Assessment</b> Carry out a Vulnerabilities Assessment and implement building elements designed to enable the project to adapt to, and mitigate, climate impacts given the project location, building /construction type and resident population.
--	-----------	--

\_\_\_\_\_ SUBTOTAL OPTIONAL POINTS

**2. LOCATION + NEIGHBORHOOD FABRIC**

<input type="radio"/> YES <input type="radio"/> NO <input type="radio"/> MAYBE	<b>M</b>	<b>2.1 Sensitive Site Protection</b> Do not locate new projects, including buildings, built structures, roads or parking areas, on portions of sites that meet any of the following provisions: <ol style="list-style-type: none"> <li>1. Land within 100 feet of wetlands, including isolated wetlands or streams. Maintain or establish riparian buffer using native vegetation where possible. Bike and foot paths are allowed if at least 25 feet from the wetlands boundary.</li> <li>2. Land on slope greater than 15%.</li> <li>3. Land with prime soils, unique soils or soils of state significance per USDA designations.</li> <li>4. Public parkland.</li> <li>5. Land that is specifically identified as an existing habitat for any species on federal or state threatened or endangered lists.</li> <li>6. Land that is within the Special Flood Hazard Areas (SFHA) as identified by FEMA on the Flood Insurance Rate Map.</li> <li>7. Land outside the corporate limits of a municipality.</li> </ol>
<input type="radio"/> YES <input type="radio"/> NO <input type="radio"/> MAYBE	<b>M</b>	<b>2.2 Connections to Existing Development and Infrastructure</b> Locate the project on a site with access to existing roads, water, sewers and other infrastructure within or contiguous to (having at least 25% of the perimeter bordering) existing development. Connect the project to the pedestrian grid.
<input type="radio"/> YES <input type="radio"/> NO <input type="radio"/> MAYBE	<b>25</b>	<b>2.3 Compact Development</b> At a minimum, build to the density level provided in the criterion.
<input type="radio"/> YES <input type="radio"/> NO <input type="radio"/> MAYBE	<b>5</b>	<b>2.4 Compact Development</b> Meet or exceed the density level provided in the criterion.
<input type="radio"/> YES <input type="radio"/> NO <input type="radio"/> MAYBE	<b>M</b>	<b>2.5 Proximity to Services</b> Locate the project within a 0.25-mile walk distance of at least two; or a 0.5-mile walk distance of at least four, of the listed services.
<input type="radio"/> YES <input type="radio"/> NO <input type="radio"/> MAYBE	<b>M</b>	<b>2.6 Preservation of and Access to Open Space for Rural / Tribal / Small Towns</b> For projects on a site at least 2 acres in size, set aside a minimum of 10% (minimum of 0.2 acre) of the total project acreage as non-paved open space for use by all occupants OR locate the project within a 0.25-mile walk distance of dedicated public non-paved open space that is a minimum of 0.75 acres.
<input type="radio"/> YES <input type="radio"/> NO <input type="radio"/> MAYBE	<b>6 max</b>	<b>2.7 Preservation of and Access to Open Space</b> Set aside a percentage of non-paved open space for use by all occupants. 20% [2 points]; 30% [4 points]; 40% + written statement of preservation /conservation policy for set-aside land [6 points].



**M** = MANDATORY  
**#** = OPTIONAL POINTS

**LOCATION + NEIGHBORHOOD FABRIC (continued)**

<input type="radio"/> YES <input type="radio"/> NO <input type="radio"/> MAYBE	<b>8 or 10</b>	<p><b>2.8 Access to Public Transportation</b>                  Locate projects within a 0.5-mile walk distance of transit services combined (bus, rail), constituting at least 20 or more transit rides per weekday, with some type of weekend ride option. [8 points]</p> <p>For projects that qualify as Rural / Tribal / Small Town, locate the project within a 5-mile distance of at least one of the following transit options: 1) vehicle share program; 2) dial-a-ride program; 3) employer vanpool; 4) park-and-ride; or 5) public-private regional transportation. [8 points]</p> <p>For an additional 2 points: Locate the project along dedicated bike trails or lanes that lead to transit services or stations (bus, rail and ferry) within 3 miles.</p>
<input type="radio"/> YES <input type="radio"/> NO <input type="radio"/> MAYBE	<b>2 to 8</b>	<p><b>2.9 Improving Connectivity to the Community</b>                  Improve access to community amenities through at least one of the transit, auto or biking mobility measures listed.</p>
<input type="radio"/> YES <input type="radio"/> NO <input type="radio"/> MAYBE	<b>5 max</b>	<p><b>2.10 Passive Solar Heating /Cooling</b>                  Design and build with passive solar design, orientation and shading that meet specified guidelines.</p>
<input type="radio"/> YES <input type="radio"/> NO <input type="radio"/> MAYBE	<b>10</b>	<p><b>2.11 Grayfield or Brownfield Site or Adaptive Reuse Building</b>                  Rehabilitate an existing structure that was not previously used as housing or locate the project on a grayfield or brownfield site.</p>
<input type="radio"/> YES <input type="radio"/> NO <input type="radio"/> MAYBE	<b>6</b>	<p><b>2.12 Access to Fresh, Local Foods</b>                  Pursue one of three options to provide residents and staff with access to fresh, local foods, including neighborhood farms and gardens, community-supported agriculture, or proximity to farmers markets.</p>
<input type="radio"/> YES <input type="radio"/> NO <input type="radio"/> MAYBE	<b>4</b>	<p><b>2.13 LEED for Neighborhood Development Certification</b></p>

SUBTOTAL OPTIONAL POINTS

**3. SITE IMPROVEMENTS**

<input type="radio"/> YES <input type="radio"/> NO <input type="radio"/> MAYBE	<b>M</b>	<p><b>3.1 Environmental Remediation</b>                  Conduct an environmental site assessment to determine whether any hazardous materials are present on-site; mitigate any found.</p>
<input type="radio"/> YES <input type="radio"/> NO <input type="radio"/> MAYBE	<b>M</b>	<p><b>3.2 Erosion and Sedimentation Control</b>                  Implement EPA's Best Management Practices for Construction Site Stormwater Runoff Control, or local requirements, whichever is more stringent.</p>
<input type="radio"/> YES <input type="radio"/> NO <input type="radio"/> MAYBE	<b>M</b>	<p><b>3.3 Low-Impact Development</b>                  Projects located on greenfields must meet the list of low-impact development criteria.</p>
<input type="radio"/> YES <input type="radio"/> NO <input type="radio"/> MAYBE	<b>M</b>	<p><b>3.4 Landscaping</b>                  If providing plantings, all should be native or adapted to the region, appropriate to the site's soil and microclimate, and none of the new plants is an invasive species. Reseed or xeriscape all disturbed areas.</p>



**M** = MANDATORY  
**#** = OPTIONAL POINTS

**SITE IMPROVEMENTS (continued)**

<input type="radio"/> YES <input type="radio"/> NO <input type="radio"/> MAYBE	<b>M</b>	<b>3.5 Surface Stormwater Management</b> Retain, infiltrate and /or harvest the first 1.25 inch of rain that falls for a 24-hour period.
<input type="radio"/> YES <input type="radio"/> NO <input type="radio"/> MAYBE	<b>1</b>	<b>3.6 Reducing Heat-Island Effect: Paving</b> Use light-colored, high-albedo materials and/or an open-grid pavement, with a minimum solar reflectance of 0.3, over at least 50% of the site's hardscaped area. Locate and plant appropriate overstory trees to provide shade for both heat island reduction and user comfort; one shade tree per 10 parking spaces minimum.

\_\_\_\_\_ SUBTOTAL OPTIONAL POINTS

**4. WATER CONSERVATION**

<input type="radio"/> YES <input type="radio"/> NO <input type="radio"/> MAYBE	<b>M</b>	<b>4.1 Water-Conserving Fixtures</b> Install water-conserving fixtures meeting the specifications in the criterion. For all single-family homes and all dwelling units in buildings three stories or fewer, the static service pressure must not exceed 60 psi.
<input type="radio"/> YES <input type="radio"/> NO <input type="radio"/> MAYBE	<b>6 max</b>	<b>4.2 Advanced Water Conservation</b> Reduce water consumption either by installing water-conserving fixtures in all units and all common space bathrooms with the following specifications: Toilets: WaterSense-labeled and 1.1 gpf [1 point]; Showerheads: WaterSense-labeled and 1.5 gpm [1 point]; Kitchen faucets: 1.5 gpm and lav faucets: WaterSense-labeled and 0.5 gpm [1 point] <b>OR</b> Reduce total indoor water consumption by at least 30% compared to the baseline indoor water consumption chart, through a combination of your choosing. [6 points maximum]
<input type="radio"/> YES <input type="radio"/> NO <input type="radio"/> MAYBE	<b>4</b>	<b>4.3 Leaks and Water Metering</b> Conduct pressure-loss tests and visual inspections to determine if there are any leaks; fix any leaks found; and meter or submeter each dwelling unit with a technology capable of tracking water use. Separately meter outdoor water consumption.
<input type="radio"/> YES <input type="radio"/> NO <input type="radio"/> MAYBE	<b>4</b>	<b>4.4 Efficient Plumbing Layout and Design</b> To minimize water loss from delivering hot water, the hot water delivery system shall store no more than 0.5 gallons of water in any piping/manifold between the hot water source and any hot water fixture.
<input type="radio"/> YES <input type="radio"/> NO <input type="radio"/> MAYBE	<b>6 max</b>	<b>4.5 Water Reuse</b> Harvest, treat, and reuse rainwater and/or greywater to meet a portion of the project's total water needs: 10% reuse [3 points]; 20% reuse [4 points]; 30% reuse [5 points]; 40% reuse [6 points]
<input type="radio"/> YES <input type="radio"/> NO <input type="radio"/> MAYBE	<b>M</b>	<b>4.6 No Irrigation and Water Reuse if Irrigation is Utilized</b> No irrigation allowed unless a system already exists on site. If an existing irrigation system is used, install an efficient irrigation or water reuse system per the guidelines

\_\_\_\_\_ SUBTOTAL OPTIONAL POINTS



**M** = MANDATORY  
**#** = OPTIONAL POINTS

## 5. ENERGY EFFICIENCY

<input type="radio"/> YES <input type="radio"/> NO <input type="radio"/> MAYBE	<b>M</b>	<b>5.1 Building Performance Requirements</b> Follow the Air Barrier and Insulation Inspection Component Guide and Energy Performance Table for measures applicable to your project.
<input type="radio"/> YES <input type="radio"/> NO <input type="radio"/> MAYBE	<b>M</b>	<b>5.1a Building Performance Standard (New Construction: single-family and low-rise multifamily)</b> Certify dwelling units in the project meet or exceed the Energy Performance Requirements in Criterion 5.1 or certify the project through the ENERGY STAR New Homes program.
<input type="radio"/> YES <input type="radio"/> NO <input type="radio"/> MAYBE	<b>M</b>	<b>5.1b Building Performance Standard (New Construction: mid-rise and high-rise multifamily, with some exceptions)</b> Certify the project through the ENERGY STAR Multifamily High-Rise program (MFHR) <b>OR</b> follow the combined MFHR and LEED Commissioning Path outlined in the criterion.  <i>Exception:</i> Multifamily buildings that are four or five stories, in which all dwelling units have their own heating, cooling and hot water systems, should comply with Criterion 5.1 and certify each dwelling unit per ENERGY STAR Certified New Homes.
<input type="radio"/> YES <input type="radio"/> NO <input type="radio"/> MAYBE	<b>M</b>	<b>5.1c Building Performance Standard (Substantial and Moderate Rehab: single-family and low-rise multifamily)</b> For each dwelling unit, achieve a HERS Index score of 85 or less.  <i>Exception:</i> Substantial rehabs of buildings with walls made only of brick/masonry that are three stories or fewer and built before 1980, as well as moderate rehabs of buildings that are three stories or fewer and built before 1980, are permitted to instead achieve a HERS Index score of 100 or less for each dwelling unit.
<input type="radio"/> YES <input type="radio"/> NO <input type="radio"/> MAYBE	<b>M</b>	<b>5.1d Building Performance Standard (Substantial and Moderate Rehab: mid-rise, high-rise, commercial and mixed use)</b> Follow the Energy Performance Requirements in Criterion 5.1 and demonstrate that the energy performance of the completed building will be equivalent to ASHRAE 90.1-2013 using an energy model created by a qualified energy services provider per Appendix G.
<input type="radio"/> YES <input type="radio"/> NO <input type="radio"/> MAYBE	<b>M</b>	<b>5.1e Building Performance Standard (New Construction: commercial and mixed use)</b> Follow the Energy Performance Requirements in Criterion 5.1 and demonstrate that the energy performance of the completed building will be 10 percent or more better than ASHRAE 90.1-2013 by using an energy model created by a qualified energy services provider per Appendix G.
<input type="radio"/> YES <input type="radio"/> NO <input type="radio"/> MAYBE	<b>5 to 12</b>	<b>5.2a Additional Reductions in Energy Use</b> Design and construct a building that is projected to be at least 5% more efficient than what is required of the project by Criteria 5.1a–e. (Projects receiving points in Criterion 5.2a may not receive points per Criterion 5.2b)
<input type="radio"/> YES <input type="radio"/> NO <input type="radio"/> MAYBE	<b>12</b>	<b>5.2b Advanced Certification: Nearing Net Zero</b> Certify the project in a program that requires advanced levels of building envelope performance such as PHIUS, Living Building Challenge and/or DOE Zero Energy Ready Home. (Projects receiving points in Criterion 5.2b may not receive points per Criterion 5.2a)



**M** = MANDATORY  
**#** = OPTIONAL POINTS

**ENERGY EFFICIENCY (continued)**

<input type="radio"/> YES <input type="radio"/> NO <input type="radio"/> MAYBE	<b>M</b>	<b>5.3 Sizing of Heating and Cooling Equipment</b> Size and select heating and cooling equipment in accordance with the Air Conditioning Contractors of America (ACCA) Manuals D, J, and S or ASHRAE handbooks.																								
<input type="radio"/> YES <input type="radio"/> NO <input type="radio"/> MAYBE	<b>M</b>	<b>5.4 ENERGY STAR Appliances</b> If providing appliances, install ENERGY STAR clothes washers, dryers, dishwashers and refrigerators. If appliances will not be installed or replaced at this time, specify that, at the time of installation or replacement, ENERGY STAR models must be used.																								
<input type="radio"/> YES <input type="radio"/> NO <input type="radio"/> MAYBE	<b>M</b>	<b>5.5 Lighting</b> Follow the guidance for high-efficacy lighting controls and other characteristics for all permanently installed lighting fixtures in project dwelling units, common spaces and exterior																								
<input type="radio"/> YES <input type="radio"/> NO <input type="radio"/> MAYBE	<b>6</b>	<b>5.6 Electricity Meter</b> Install individual or submetered electric meters for all dwelling units.																								
<input type="radio"/> YES <input type="radio"/> NO <input type="radio"/> MAYBE	<b>4</b>	<b>5.7a Photovoltaic / Solar Hot Water Ready</b> Orient, design, engineer, wire and /or plumb the development to accommodate installation of photovoltaic (PV) or solar hot water system in the future.																								
<input type="radio"/> YES <input type="radio"/> NO <input type="radio"/> MAYBE	<b>10 max</b>	<p><b>5.7b Renewable Energy</b> Install photovoltaic (PV) panels or other electric-generating renewable energy source to provide a specified percentage of the project’s estimated total energy demand or water heating energy demand. (Projects may earn points through Criterion 5.7b or 5.8b, but not both.)</p> <table border="1" style="width: 100%; border-collapse: collapse;"> <thead> <tr> <th></th> <th style="text-align: center;">5%</th> <th style="text-align: center;">10%</th> <th style="text-align: center;">20%</th> <th style="text-align: center;">30%</th> <th style="text-align: center;">40%</th> </tr> </thead> <tbody> <tr> <td>Single-story / Single-family</td> <td style="text-align: center;">—</td> <td style="text-align: center;">—</td> <td style="text-align: center;">6</td> <td style="text-align: center;">8</td> <td style="text-align: center;">10</td> </tr> <tr> <td>2 to 3 stories</td> <td style="text-align: center;">—</td> <td style="text-align: center;">6</td> <td style="text-align: center;">8</td> <td style="text-align: center;">10</td> <td style="text-align: center;">—</td> </tr> <tr> <td>4 stories or more</td> <td style="text-align: center;">6</td> <td style="text-align: center;">8</td> <td style="text-align: center;">10</td> <td style="text-align: center;">—</td> <td style="text-align: center;">—</td> </tr> </tbody> </table>		5%	10%	20%	30%	40%	Single-story / Single-family	—	—	6	8	10	2 to 3 stories	—	6	8	10	—	4 stories or more	6	8	10	—	—
	5%	10%	20%	30%	40%																					
Single-story / Single-family	—	—	6	8	10																					
2 to 3 stories	—	6	8	10	—																					
4 stories or more	6	8	10	—	—																					
<input type="radio"/> YES <input type="radio"/> NO <input type="radio"/> MAYBE	<b>8</b>	<b>5.8a Resilient Energy Systems: Floodproofing</b> Conduct floodproofing, including perimeter floodproofing (barriers /shields), of lower floors. Design and install building systems as specified by the full criterion so that the operation of those systems will not be grossly affected in case of a flood.																								
<input type="radio"/> YES <input type="radio"/> NO <input type="radio"/> MAYBE	<b>4 to 8</b>	<b>5.8b Resilient Energy Systems: Islandable Power</b> Provide emergency power through an islandable photovoltaic (PV) system or an efficient and portable generator that will offer at least limited electricity for critical circuits during power outages per one of the three options listed. (Projects may earn points through Criterion 5.7b or 5.8b, but not both.)																								
<input type="radio"/> YES <input type="radio"/> NO <input type="radio"/> MAYBE	<b>M</b>	<b>5.9 Advanced Framing</b> Follow advanced framing (optimum value engineering) best practices for all framing where possible.																								
<input type="radio"/> YES <input type="radio"/> NO <input type="radio"/> MAYBE	<b>5</b>	<b>5.10 Advanced Metering</b> Site, design, engineer, and wire the development to accommodate installation of smart meters and /or be able to interface with smart grid systems in the future.																								

SUBTOTAL OPTIONAL POINTS



**M** = MANDATORY  
**#** = OPTIONAL POINTS

## 6. MATERIALS

<input type="radio"/> YES <input type="radio"/> NO <input type="radio"/> MAYBE	<b>M</b>	<b>6.1 Low/ No VOC Paints, Coatings and Primers</b> All interior paints and primers must have VOC levels, in grams per liter, less than or equal to the thresholds established by South Coast Air Quality Management District (SCAQMD) Rule 1113.
<input type="radio"/> YES <input type="radio"/> NO <input type="radio"/> MAYBE	<b>M</b>	<b>6.2 Low/ No VOC Adhesives and Sealants</b> All adhesives and sealants (including caulks) must have VOC levels, in grams per liter, less than or equal to the thresholds established by the South Coast Air Quality Management District Rule 1168.
<input type="radio"/> YES <input type="radio"/> NO <input type="radio"/> MAYBE	<b>3</b> <b>max</b>	<b>6.3 Recycled Content Material</b> Incorporate building materials that are composed of at least 25% post-consumer recycled content or at least 50% post-industrial recycled content. [1 point] Building materials that make up at least 75% of their project component each receive 1 point.
<input type="radio"/> YES <input type="radio"/> NO <input type="radio"/> MAYBE	<b>4</b> <b>max</b>	<b>6.4 Regional Materials</b> Use products that were extracted, processed and manufactured within 500 miles of the project for a minimum of 50%, based on cost, of the building materials' value. Select any or all of these options (each material can qualify for 1 point): <ul style="list-style-type: none"> <li>· Framing materials</li> <li>· Exterior materials (e.g., siding, masonry, roofing)</li> <li>· Flooring materials</li> <li>· Concrete/cement and aggregate material</li> <li>· Drywall/interior sheathing materials</li> </ul>
<input type="radio"/> YES <input type="radio"/> NO <input type="radio"/> MAYBE	<b>1</b>	<b>6.5 Certified, Salvaged and Engineered Wood Products</b> For at least 25% of all structural wood products, by cost or value, commit to using either FSC-certified, salvaged products or engineered framing materials without urea formaldehyde.
<input type="radio"/> YES <input type="radio"/> NO <input type="radio"/> MAYBE	<b>M</b>	<b>6.6 Composite Wood Products that Emit Low/No Formaldehyde</b> All composite wood products must be certified as compliant with California 93120 Phase 2 OR, if using a composite wood product that does not comply with California 93120 Phase 2, all exposed edges and sides must be sealed with low-VOC sealants, per Criterion 6.2.
<input type="radio"/> YES <input type="radio"/> NO <input type="radio"/> MAYBE	<b>M</b>	<b>6.7a Environmentally Preferable Flooring</b> Do not install carpets in building entryways, laundry rooms, bathrooms, kitchens/ kitchenettes, utility rooms or any rooms built on foundation slabs. Where installed, all carpet products must meet the Carpet and Rug Institute's Green Label or Green Label Plus certification for carpet, pad and carpet adhesives. Any hard surface flooring products must be either ceramic tile or solid unfinished hardwood floors, or meet the Scientific Certification System's FloorScore program criteria (including pre-finished hardwood flooring).
<input type="radio"/> YES <input type="radio"/> NO <input type="radio"/> MAYBE	<b>6</b>	<b>6.7b Environmentally Preferable Flooring: Throughout Building</b> Use non-vinyl, non-carpet floor coverings throughout each building in the project.



**M** = MANDATORY  
**#** = OPTIONAL POINTS

**MATERIALS (continued)**

<input type="radio"/> YES <input type="radio"/> NO <input type="radio"/> MAYBE	<b>M</b>	<b>6.8 Mold Prevention: Surfaces</b> Use materials that have durable, cleanable surfaces throughout bathrooms, kitchens and laundry rooms. Materials installed in these rooms should not be prone to deterioration due to moisture intrusion or encourage the growth of mold.
<input type="radio"/> YES <input type="radio"/> NO <input type="radio"/> MAYBE	<b>M</b>	<b>6.9 Mold Prevention: Tub and Shower Enclosures</b> Use moisture-resistant backing materials such as cement board, fiber cement board or equivalent per ASTM #D3273 behind tub/shower enclosures. Projects using a one-piece fiberglass tub/shower enclosure are exempt from this requirement.
<input type="radio"/> YES <input type="radio"/> NO <input type="radio"/> MAYBE	<b>12 max</b>	<b>6.10 Asthmagen-Free materials</b> Do not install products that contain ingredients that are known to cause or trigger asthma. Key products to avoid are: <ul style="list-style-type: none"> <li>• <i>Insulation:</i> Do not use spray polyurethane foam (SPF) or formaldehyde-containing fiberglass batts. [4 points]</li> <li>• <i>Flooring:</i> Do not use flexible vinyl (PVC) roll or sheet flooring or carpet-backed with vinyl with phthalates. Do not use fluid applied finish floors. [4 points]</li> <li>• <i>Wall coverings:</i> Do not use wallpaper made from vinyl (PVC) with phthalates or site-applied high-performance coatings that are epoxy or polyurethane based. [4 points]</li> <li>• <i>Composite wood:</i> Use only ULEF products for cabinetry, subflooring and other interior composite wood uses. [4 points]</li> </ul>
<input type="radio"/> YES <input type="radio"/> NO <input type="radio"/> MAYBE	<b>5</b>	<b>6.11 Reduced Heat-Island Effect: Roofing</b> Use an ENERGY STAR–certified roofing product for 100% of the roof area <b>OR</b> install a “green” (vegetated) roof for at least 50% of the roof area and ENERGY STAR–certified roofing product for the remainder of the roof area.
<input type="radio"/> YES <input type="radio"/> NO <input type="radio"/> MAYBE	<b>M or 6 max</b>	<b>6.12 Construction Waste Management</b> Commit to following a waste management plan that reduces non-hazardous construction and demolition waste through recycling, salvaging or diversion strategies through one of the three options. Achieve optional points by going above and beyond the requirement.
<input type="radio"/> YES <input type="radio"/> NO <input type="radio"/> MAYBE	<b>3</b>	<b>6.13 Recycling Storage</b> Provide separate bins for the collection of trash and recycling for each dwelling unit or office and all shared and all shared community rooms (if applicable).  Additionally, in multifamily buildings, provide at least one easily accessible, permanent and dedicated indoor area for the collection and storage of materials for recycling. In single-family homes, points will be accrued only if curb-side recycling pickup is available.  Collected materials should include, at a minimum, paper, cardboard, glass, metals and plastics.

\_\_\_\_\_ SUBTOTAL OPTIONAL POINTS



**M** = MANDATORY  
**#** = OPTIONAL POINTS

**7. HEALTHY LIVING ENVIRONMENT**

<p><input type="radio"/> YES <input type="radio"/> NO <input type="radio"/> MAYBE</p> <p><input type="radio"/> YES <input type="radio"/> NO <input type="radio"/> MAYBE</p>	<p><b>M</b> <b>7.1 Ventilation</b>  <i>New Construction and Substantial Rehab</i></p> <p><b>12</b> <i>Moderate Rehab</i>  <b>max</b></p> <p><b>Residential Projects</b>                  For each dwelling unit, in full accordance with ASHRAE 62.2-2013, install a local mechanical exhaust system in each bathroom [4 points], a local mechanical exhaust system in each kitchen [4 points], and a whole-house mechanical ventilation system [4 points].                  For each multifamily building of four stories and more, in full accordance with ASHRAE 62.1-2013, install a mechanical ventilation system for all hallways and common spaces [3 points].                  For all project types, in addition to the above requirements:</p> <ul style="list-style-type: none"> <li>· All systems and associated ductwork must be installed per manufacturer's recommendations.</li> <li>· All individual bathroom fans must be ENERGY STAR labeled, wired to turn on with the light switch or separate switch, and equipped with a humidistat sensor, timer or other control (e.g., occupancy sensor, delay off switch, ventilation controller).</li> <li>· If using central ventilation systems with rooftop fans, each rooftop fan must be direct-drive and variable-speed with speed controller mounted near the fan. Fans with design CFM 300-2000 must also have an ECM motor.</li> </ul> <p><b>Non-Residential Projects</b>                  Comply with ASHRAE 62.1-2013.</p>
<p><input type="radio"/> YES <input type="radio"/> NO <input type="radio"/> MAYBE</p>	<p><b>M</b> <b>7.2 Clothes Dryer Exhaust</b>                  Clothes dryers must be exhausted directly to the outdoors using rigid-type ductwork (except for condensing dryers, which must be plumbed to a drain).</p>
<p><input type="radio"/> YES <input type="radio"/> NO <input type="radio"/> MAYBE</p>	<p><b>M</b> <b>7.3 Combustion Equipment</b>                  For new construction and rehab projects, specify power-vented or direct vent equipment when installing any new combustion appliance for space or water heating that will be located within the conditioned space.</p> <p>In Substantial and Moderate Rehabs, if there is any combustion equipment located within the conditioned space for space or water heating that is not power-vented or direct vent and that is not scheduled for replacement, conduct initial combustion safety testing per the given guidelines.</p> <p>Install one hard-wired carbon monoxide (CO) alarm with battery backup function for each sleeping zone, placed per National Fire Protection Association (NFPA) 720.</p>



**M** = MANDATORY  
**#** = OPTIONAL POINTS

### HEALTHY LIVING ENVIRONMENT (continued)

<input type="radio"/> YES <input type="radio"/> NO <input type="radio"/> MAYBE	<b>9 or 11</b>	<p><b>7.4 Elimination of Combustion Within the Conditioned Space</b>            No combustion equipment may be used for cooking (to include, but not limited to ranges, cooktops, stoves, ovens) as part of the building project [9 points]</p> <p style="text-align: center;"><b>OR</b></p> <p>no combustion equipment may be used as part of the building project [11 points].</p>
<input type="radio"/> YES <input type="radio"/> NO <input type="radio"/> MAYBE	<b>M</b>	<p><b>7.5 Vapor Retarder Strategies</b>            Install vapor barriers that meet specified criteria appropriate for the foundation type.</p>
<input type="radio"/> YES <input type="radio"/> NO <input type="radio"/> MAYBE	<b>M</b>	<p><b>7.6 Water Drainage</b>  <b>(For all New Construction and those Rehab projects that include replacing particular assemblies)</b>            Provide drainage of water away from walls, windows and roofs by implementing the list of techniques.</p>
<input type="radio"/> YES <input type="radio"/> NO <input type="radio"/> MAYBE	<b>M</b>	<p><b>7.7 Mold Prevention: Water Heaters</b>            Provide adequate drainage for water heaters that includes drains or catch pans with drains piped to the exterior of the dwelling.</p>
<input type="radio"/> YES <input type="radio"/> NO <input type="radio"/> MAYBE	<b>M</b>	<p><b>7.8 Radon Mitigation</b>            Install passive radon-resistant features below the slab and a vertical vent pipe with junction box within 10 feet of an electrical outlet in case an active system should prove necessary in the future. For Substantial Rehab projects in EPA Zone 1, test and mitigate per the specified protocols.</p>
<input type="radio"/> YES <input type="radio"/> NO <input type="radio"/> MAYBE	<b>M</b>	<p><b>7.9 Garage Isolation</b></p> <ul style="list-style-type: none"> <li>· Provide a continuous air barrier between the conditioned space and any garage space to prevent the migration of any contaminants into the occupied space. Visually inspect common walls and ceilings between attached garages and living spaces to ensure that they are air-sealed before insulation is installed.</li> <li>· Do not install ductwork or air handling equipment in a garage.</li> <li>· Fix all connecting doors between conditioned space and garage with gaskets or otherwise make substantially airtight with weather stripping.</li> <li>· Install one hard-wired carbon monoxide (CO) alarm with battery backup function for each sleeping zone of the project, placed per National Fire Protection Association (NFPA) 720.</li> </ul>
<input type="radio"/> YES <input type="radio"/> NO <input type="radio"/> MAYBE	<b>M</b>	<p><b>7.10 Integrated Pest Management</b>            Seal all wall, floor, and joint penetrations with low-VOC caulking or other appropriate nontoxic sealing methods to prevent pest entry.</p>
<input type="radio"/> YES <input type="radio"/> NO <input type="radio"/> MAYBE	<b>9</b>	<p><b>7.11a Beyond ADA: Universal Design</b>  <b>(New Construction)</b>            Design a minimum of 15% of the dwelling units (no fewer than one) in accordance with ICC /ANSI A117.1, Type A, Fully Accessible guidelines. Design the remainder of the ground-floor units and elevator-reachable units in accordance with ICC /ANSI A117.1, Type B.</p>



**M** = MANDATORY  
**#** = OPTIONAL POINTS

**HEALTHY LIVING ENVIRONMENT (continued)**

<p><input type="radio"/> YES <input type="radio"/> NO <input type="radio"/> MAYBE</p>	<p><b>7 or 9</b></p>	<p><b>7.11b Beyond ADA: Universal Design (Substantial and Moderate Rehab)</b>                  Design a minimum of 10% of the dwelling units (one, at minimum) in accordance with ICC /ANSI A117.1, Type A, Fully Accessible guidelines. [7 points]</p> <p><i>For an additional 2 points:</i> Design the remainder of the ground-floor units and elevator-reachable units with accessible unit entrances designed to accommodate people who use a wheelchair.</p>
<p><input type="radio"/> YES <input type="radio"/> NO <input type="radio"/> MAYBE</p>	<p><b>M</b></p>	<p><b>7.12 Active Design: Promoting Physical Activity Within the Building</b>                  Situate at least one building stairway per the criterion to encourage use  <b>OR</b>                  emphasize at least one strategy inside the building designed to increase frequency and duration of physical activity per the criterion.</p>
<p><input type="radio"/> YES <input type="radio"/> NO <input type="radio"/> MAYBE</p>	<p><b>10</b></p>	<p><b>7.13 Active Design: Staircases and Building Circulation</b>                  A staircase must be accessible and visible from the main lobby as well as visible within a 25-foot walking distance from any edge of lobby. Ensure that no turns or obstacles prevent visibility of or accessibility to the qualifying staircase from the lobby, and that the staircase is encountered before or at the same time as the elevators.</p> <p>From the corridor, accessible staircases should be made visible by: Providing transparent glazing of at least 10 square feet (1 square meter) at all stair doors or at a side light OR providing magnetic door holds on all doors leading to the stairs OR removing door enclosures / vestibules.</p>
<p><input type="radio"/> YES <input type="radio"/> NO <input type="radio"/> MAYBE</p>	<p><b>9</b></p>	<p><b>7.14 Interior and Outdoor Activity Spaces for Children and Adults</b>                  Provide an on-site dedicated recreation space with exercise or play opportunities for adults and /or children that is open and accessible to all residents; see criterion for specifics.</p>
<p><input type="radio"/> YES <input type="radio"/> NO <input type="radio"/> MAYBE</p>	<p><b>10</b></p>	<p><b>7.15 Smoke-Free Building</b>                  Implement and enforce a no-smoking policy in all common and individual living areas, and within a 25-foot perimeter around the exterior of all residential projects.</p>

\_\_\_\_\_ SUBTOTAL OPTIONAL POINTS



**M** = MANDATORY  
**#** = OPTIONAL POINTS

**8. OPERATIONS, MAINTENANCE + OCCUPANT ENGAGEMENT**

<input type="radio"/> YES <input type="radio"/> NO <input type="radio"/> MAYBE	<p><b>M</b> <b>8.1 Building Operations &amp; Maintenance (O&amp;M) Manual and Plan</b>                  Develop a manual with thorough building operations and maintenance guidance and a complementary plan. The manual and plan should be developed over the course of the project design, development and construction stages, and should include sections/ chapters addressing the list of topics.</p>
<input type="radio"/> YES <input type="radio"/> NO <input type="radio"/> MAYBE	<p><b>M</b> <b>8.2 Emergency Management Manual</b>                  Provide a manual on emergency operations targeted toward operations and maintenance staff and other building-level personnel. The manual should address responses to various types of emergencies, leading with those that have the greatest probability of negatively affecting the project. The manual should provide guidance as to how to sustain the delivery of adequate housing and services throughout an emergency and cover a range of topics, including but not limited to:</p> <ul style="list-style-type: none"> <li>· communication plans for staff and occupants</li> <li>· useful contact information for public utility and other service providers</li> <li>· infrastructure and building “shutdown” procedures</li> </ul>
<input type="radio"/> YES <input type="radio"/> NO <input type="radio"/> MAYBE	<p><b>M</b> <b>8.3 Occupant Manual</b>                  Provide a guide for building tenant that explains the intent, benefits, use and maintenance of their building’s green features and practices. The Occupant Manual should encourage green and healthy activities per the list of topics.</p>
<input type="radio"/> YES <input type="radio"/> NO <input type="radio"/> MAYBE	<p><b>M</b> <b>8.4 Occupant and Property Staff Orientation</b>                  Provide a comprehensive walk-through and orientation for all occupants, property manager(s) and buildings operations staff. Use the appropriate manuals (see Criteria 8.1, 8.2, 8.3) as the base of the curriculum, and review the project’s green features, operations and maintenance procedures, and emergency protocols.</p>
<input type="radio"/> YES <input type="radio"/> NO <input type="radio"/> MAYBE	<p><b>M</b> <b>8.5 Project Data Collection and Monitoring System:                  100% Non-Residential, 15% - 50% Residential / Mixed Use</b>                  Collect and monitor project energy and water performance data for 100% of commercial units and 15% - 50% of residential units depending on total number of units. Allow IEDA access to this data.</p>

\_\_\_\_\_ SUBTOTAL OPTIONAL POINTS

\_\_\_\_\_ **TOTAL OPTIONAL POINTS**

## INTEGRATIVE DESIGN

INTRODUCTION CRITERIA  
CHECKLIST

- 1 **INTEGRATIVE DESIGN**
- 2 LOCATION +  
NEIGHBORHOOD FABRIC
- 3 SITE IMPROVEMENTS
- 4 WATER CONSERVATION
- 5 ENERGY EFFICIENCY
- 6 MATERIALS
- 7 HEALTHY LIVING  
ENVIRONMENT
- 8 OPERATIONS,  
MAINTENANCE  
+ OCCUPANT  
ENGAGEMENT

APPENDIX

A SUCCESSFUL INTEGRATIVE  
DESIGN PROCESS  
FACILITATES THE DESIGN  
AND DEVELOPMENT TEAM'S  
ACHIEVEMENT OF THEIR  
OBJECTIVES THROUGHOUT  
THE PROJECT LIFE CYCLE.

## 1.1A GOAL SETTING

### MANDATORY

#### *REQUIREMENTS*

A successful integrative design process is more art than science. It also is often the determining factor in ultimately achieving a successful project. Develop an integrative design process that works best for your project team and intentions. At minimum, document:

1. A statement of the overall green development goals of the project and the expected intended outcomes from addressing those goals.
2. A summary of the integrative process that was used to select the green building strategies, systems and materials that will be incorporated into the project.
3. A description of how progress and success against these goals will be measured throughout the completion of design, construction and operation to ensure that the green features are included and correctly installed.

Conduct one or more integrative design meeting(s) as appropriate for the project and submit a completed Appendix A Green Development Plan or equivalent documentation outlining the design approach used that demonstrates involvement of the entire project team throughout the design and development process.

The output of an integrated design charrette should include, at a minimum:

- Project objectives / intended outcomes;
- Key building strategies;
- Systems integration (envelope, lighting, HVAC, site design, materials, etc.);
- Project values (“First Principles”) to guide any budget and value engineering decisions to be made; and
- How the Iowa Green Streets Criteria will be met and who the responsible party is for each criterion.

Include the following in the Appendix A Green Development Plan submittal:

- A roster of the name and role of each member of the professional design and development team participating in the integrative design meeting;
- A statement of the overall green development goals of the project and the expected intended outcomes from addressing those goals;
- Project goals and values (“First Principles”) to guide any budget and value engineering decisions to be made, so that the green development goals and intended outcomes are protected;
- A summary of process used to select the green building strategies, systems, and materials;
- A description of how each of the mandatory and optional items will be included in the project;
- Identification of development team members responsible for implementing the green features;
- A description of follow-up measures to be taken through completion of design, permitting, construction, and operation ensuring the green features are included and correctly installed, and that owners / tenants receive information about the function and operation of the features; and
- Meeting minutes or other documentation that captures and summarizes components of the integrative design process.

See Appendix I for an example green charrette agenda and example charrette outcome product to guide the work of producing your green development plan. Also utilize the [Green Charrette Toolkit](#).

## *RATIONALE*

Integrative design is used to maximize project budget and effective solutions with a holistic, comprehensive approach. As a result, it is supported by criteria in all of the other categories. An integrative project delivery process facilitates the design and development team's achievement of green objectives throughout the project life cycle. The outcomes of an integrative project delivery process can include substantially lower development costs and greater health, economic and environmental benefits for residents, property owners and communities.

## *RECOMMENDATIONS*

- Conduct a design charrette with the full development team, including ALL the following disciplines:
  - Prospective or current residents or building occupants;
  - Architecture;
  - Mechanical engineering;
  - Electrical engineering;
  - Building science;
  - HERS Rater or commissioning agent;
  - Green building or sustainable design;
  - Civil engineering and landscape architecture and ecological sciences / habitat restoration, and land-use planning;
  - Building management and maintenance;
  - Public health; AND
  - Others as appropriate- i.e. urban agriculture, education/outreach, etc.
- Add building envelope and mechanical installation details to your plans and specifications for the most critical project components, paying particular attention to: air handler closet air sealing, floor system and band air sealing, party wall air sealing, proper insulation installation, ventilation system installation, and duct sealing with “bucket” mastic. Also provide the construction team with installation guides for the measures above.
- Consider creating incentives for your construction team based on the performance of various building components.
- Add self-verification requirements for your construction team for certain project items that demand proper installation (e.g., testing of water fixtures, testing of bath fans, air sealing of air handler closets). Self-verification for product-based measures (submitting cut-sheets for appropriate paints, carpets, etc.) is most likely unnecessary.

## RESOURCES

- Review the [Enterprise Green Communities Pre-Development Design Toolkit](#), [Project Management Guide](#), [Green Charrette Toolkit](#) and Green Development Plan (see Resources). These help you set the framework for a meaningful integrative design process for your project. The Pre-Development Design Toolkit includes a template and a description of creating a project Design Brief (essentially an owner’s project requirements [OPR] document) and guidance on how to select the most qualified architect for the project. The Project Management Guide relays the iterative process of how the Enterprise Green Communities Criteria weave throughout a typical project’s development timeline. The Green Charrette Toolkit includes sample agendas and facilitator guides. [www.enterprisecommunity.org/solutions-and-innovation/green-communities/tools-and-services/charrette-toolkit](http://www.enterprisecommunity.org/solutions-and-innovation/green-communities/tools-and-services/charrette-toolkit)
- Hire a project design team with documented experience in designing and overseeing construction of high performing buildings. The Iowa chapter of the American Institute of Architects maintains a searchable directory of architectural firms specializing in sustainable design as well as historic preservation. [www.aiaiowa.org/search/custom.asp?id=1701](http://www.aiaiowa.org/search/custom.asp?id=1701)
- Whole Building Design Guide: This website describes the core elements of “whole building design,” which includes the combination of an integrative design approach and an integrative team process. This site helps users identify design objectives and organize their processes to meet those objectives. [www.wbdg.org/wbdg\\_approach.php](http://www.wbdg.org/wbdg_approach.php)

## 1.1B CRITERIA DOCUMENTATION

### MANDATORY

#### REQUIREMENTS

Create design and construction documentation (e.g., plans, details, specifications, subcontractor scopes of work) to include information on implementation of appropriate Iowa Green Streets Criteria, and other mission-critical design features. Plans and specs should include a performance specification, examples of products that meet the specification, the metrics used to measure compliance and how compliance will be confirmed.

Use the Project Plan and Spec Book Checklist below to assist the project in incorporating all applicable Iowa Green Streets Criteria mandatory and optional measures into the project’s plans and specifications. Provide the Project Plan and Spec Book Checklist and the Iowa Green Streets Criteria to all contractors and subcontractors and inform all contractors of need to comply with the criteria. Have the project designer / architect call out and highlight criterion in project plans and list page numbers on the checklist below.

**Upload the completed checklist to the grant recipient’s “Electronic Documents” section of [www.iowagrants.gov](http://www.iowagrants.gov) prior to going out to bid for project construction.**



*PROJECT PLAN AND SPEC BOOK CHECKLIST*

CRITERION	PROJECT PLANS	Page #	SPEC BOOK	Page #	Architect/ Designer Initials
1.1a-Goal Setting					
1.1b Criteria Documentation					
1.2a Occupant Health and Well-Being: Design for Health					
1.2b Occupant Health and Well-Being: Health Action Plan					
1.3a Resilient Communities: Design for Resilience					
1.3b Resilient Communities Multi-Hazard Risk / Assessment					
2.1 Sensitive Site Protection					
2.2 Connections to Existing Development and Infrastructure					
2.3-4 Compact Development					
2.5 Proximity to Services					
2.6-7 Preservation of and Access to Open Space					
2.8 Access to Public Transportation					
2.9 Improving Connectivity to the Community					
2.10 Passive Solar Heating/Cooling					
2.11 Grayfield, Brownfield or Adaptive Reuse					
2.12 Access to Fresh, Local Foods					
2.13 LEED for Neighborhood Development					
3.1 Environmental Remediation					
3.2 Erosion and Sedimentation Control					
3.3 Low-Impact Development					
3.4 Landscaping					
3.5 Surface Water Management					
3.6 Reducing Heat-Island Effect: Paving					
4.1 Water-Conserving Fixtures					
4.2 Advanced Water Conservation					
4.3 Leaks and Water Metering					
4.4 Efficient Plumbing Layout and Design					
4.5 Water Reuse					
4.6 No Irrigation and Irrigation with Harvested Water					



CRITERION	PROJECT PLANS	Page #	SPEC BOOK	Page #	Architect/ Designer Initials
5.1 Building Performance Requirements					
5.1a–e Building Performance Standards					
5.2 Additional Reductions in Energy Use					
5.2b Advanced Certification: Nearing Net Zero					
5.3 Sizing of Heating and Cooling Equipment					
5.4 ENERGY STAR Appliances					
5.5a Lighting					
5.6 Electricity Meter					
5.7a Photovoltaic / Solar Hot Water Ready					
5.7b Renewable Energy					
5.8a Resilient Energy Systems: Floodproofing					
5.8b Resilient Energy Systems: Islandable Power					
5.9 Advanced Framing					
5.10 Advanced Metering Infrastructure					
6.1 Low/No VOC Paints and Primers					
6.2 Low/No VOC Adhesives and Sealants					
6.3 Recycled Content Material					
6.4 Regional Materials					
6.5 Certified, Salvaged, and Engineered Wood Products					
6.6 Composite Wood Products that Emit Low/No Formaldehyde					
6.7a-b Environmentally Preferable Flooring					
6.8 Mold Prevention: Services					
6.9 Mold Prevention: Tub and Shower Enclosures					
6.10 Asthmagen-Free Materials					
6.11 Reducing Heat-Island Effect: Roofing					
6.12 Construction Waste Management					
6.13 Recycling Storage					
7.1 Ventilation					
7.2 Clothes Dryer Exhaust					
7.3 Combustion Equipment					

CRITERION	PROJECT PLANS	Page #	SPEC BOOK	Page #	Architect/ Designer Initials
7.4 Elimination of Combustion Within the Conditioned Space					
7.5 Vapor Retarder Strategies					
7.6 Water Drainage					
7.7 Mold Prevention: Water Heaters					
7.8 Radon Mitigation					
7.9 Garage Isolation					
7.10 Integrated Pest Management					
7.11a-b Beyond ADA: Universal Design					
7.12 Active Design: Promoting Physical Activity Within the Building					
7.13 Active Design: Staircases and Building Circulation					
7.14 Interior and Outdoor Activity Spaces for Children and Adults					
7.15 Smoke Free Building					
8.1 Building Operations and Maintenance (O&M) Manual and Plan					
8.2 Emergency Management Manual					
8.3 Occupant Manual					
8.4 Occupant and Property Manager(s) Orientation					
8.5 Project Data Collection and Monitoring System					

## *RATIONALE*

Projects that explicitly address accountability among project team members and implementation details for Iowa Green Streets Criteria in design and construction documentation tend to successfully implement the criteria on-site during the construction phase. The intent of this criterion is for measures selected through Criterion 1.1a to be thoroughly integrated into that design and the construction documents.

## *RECOMMENDATIONS*

Incorporate all Iowa Green Streets Criteria mandatory and optional measures that the project intends to meet as indicated in the Green Development Plan.

## RESOURCES

- Building America’s Climate-Specific Guidance: [energy.gov/eere/buildings/building-america-climate-specific-guidance](https://energy.gov/eere/buildings/building-america-climate-specific-guidance) and the Building America Solution Center: [basc.pnnl.gov](https://basc.pnnl.gov) provide residential building professionals with access to expert information on hundreds of high-performance design and construction topics. They include contracting documents and specifications, installation guidance, CAD drawings, “right and wrong” photographs of installation practices and training videos.
- Enterprise Green Communities Single-Family Rehabilitation Specifications, Multifamily Rehabilitation Specifications and Universal Design Specifications for both multifamily and single-family residences include customizable specifications for you to copy, adjust and use for your projects. [www.enterprisecommunity.org/solutions-and-innovation/green-communities/tools-and-services/construction-specifications](https://www.enterprisecommunity.org/solutions-and-innovation/green-communities/tools-and-services/construction-specifications)

## 1.2A OCCUPANT HEALTH AND WELL-BEING: DESIGN FOR HEALTH

### MANDATORY

#### REQUIREMENTS

Identify potential resident, building occupant, client health factors and design your project to address health and well-being. Using the matrix below in this criterion, the project team will:

- Use readily accessible community health data sets and /or community engagement processes and identify at least one relevant Resident Health Campaign (*left-hand column*) for their project.
- Indicate which sources of information were used to select the most relevant Health and Well-Being Campaign (*complete second column*). These may include specific local and regional health data, insights from community meetings or surveys, or reports from local health professionals.
- Identify building design and programming factors that can optimize health and well-being (*column three*).
- Incorporate at least one optional criterion (*column four*) associated with the selected Health and Well-Being Campaign(s) into project documents.

#### RATIONALE

Health and well-being are influenced by a range of factors, including individual genetics and behaviors, social determinants of health, overarching political and economic influences, and, most important for developers and designers, determinants in the built environment. Where you live, work, learn and play impacts health outcomes. Unfortunately, data shows that low-income and certain racial and ethnic minority populations are disproportionately affected by these factors, and often suffer from poor health. Low-income communities often suffer from higher rates of asthma, cardiovascular disease, diabetes, cancer, mental health issues, and injury and death (resulting from violence, substance abuse and transportation-related incidents), relative to higher-resourced surrounding communities. These inequities have an impact on the length and quality of residents’ lives, as well as their ability to work, learn and be productive members of society. Project teams can learn more about the connections between the built environment and health outcomes through materials provided in the Resources section of this criterion.

#### *RESIDENT HEALTH CAMPAIGNS AND ASSOCIATED CRITERIA MA-*



TRIX

RESIDENT HEALTH CAMPAIGNS	SOURCE(S) OF INFORMATION	BUILDING DESIGNS AND PROGRAMMING THAT INFLUENCE PHYSICAL AND MENTAL HEALTH	RELATED CRITERIA
Injury and Accessibility		<ul style="list-style-type: none"> <li>· Physical accessibility of the site and building</li> <li>· Mobility</li> <li>· Presence of traffic calming measures</li> <li>· Speed limits</li> <li>· Urbanicity</li> <li>· Social cohesion</li> <li>· Access to health and community services and supports</li> <li>· Fall prevention features such as stair gates, window guards, handrails, grab bars and improved lighting</li> <li>· Safety of bicycle environment, infrastructure and facilities</li> <li>· Outdoor safety and security / crime</li> <li>· Safety of sidewalks and pedestrian environment, infrastructure and facilities</li> <li>· Safety of transit and vehicle environment, infrastructure and facilities</li> <li>· Access to affordable transportation services</li> </ul>	<p><b>Mandatory Criteria</b></p> <p>2.5 Proximity to Services</p> <p><b>Optional Criteria</b></p> <p>2.8 Access to Public Transportation</p> <p>2.9 Improving Connectivity to the Community</p> <p>2.13 LEED-ND Certification</p> <p>7.11a Beyond ADA: Universal Design — New Construction</p> <p>7.11b Beyond ADA: Universal Design — Substantial and Moderate Rehab</p>
Asthma and Respiratory Health		<ul style="list-style-type: none"> <li>· Outdoor air quality</li> <li>· Indoor air quality</li> <li>· Indoor humidity and temperature</li> <li>· Mold</li> <li>· Plant allergens</li> <li>· Use of toxic /c carcinogenic products (e.g., for cleaning)</li> <li>· Smoking</li> <li>· Access to affordable chronic disease management services and resources</li> <li>· Presence of pests</li> </ul>	<p><b>Mandatory Criteria</b></p> <p>5.1 Building Performance Requirements</p> <p>5.1a–e Building Performance Standard</p> <p>5.3 Sizing of Heating and Cooling Equipment</p> <p>6.7a Environmentally Preferable Flooring</p> <p>7.1 Ventilation</p> <p>7.2 Clothes Dryer Exhaust</p> <p>7.5 Vapor Retarder Strategies</p> <p>7.7 Mold Prevention: Water Heaters</p> <p>7.10 Integrated Pest Management</p> <p>8.1 Building O&amp;M Manual and Plan</p> <p>8.3 Occupant Manual</p> <p><b>Optional Criteria</b></p> <p>6.5 Certified, Salvaged and Engineered Wood Products</p> <p>6.7b Environmentally Preferable Flooring: Throughout Building</p> <p>6.10 Asthmagen-Free Materials</p> <p>7.16 Smoke-Free Building</p>



RESIDENT HEALTH CAMPAIGNS	SOURCE(S) OF INFORMATION	BUILDING DESIGNS AND PROGRAMMING THAT INFLUENCE PHYSICAL AND MENTAL HEALTH	RELATED CRITERIA
Cardiovascular Disease, Diabetes (Type II), and Obesity		<ul style="list-style-type: none"> <li>· Proximity to essential goods and services (e.g., grocery stores, retail, schools, medical care)</li> <li>· Proximity and access to public transportation</li> <li>· Air temperature (avoidance of extreme heat and cold)</li> <li>· Air quality</li> <li>· Access to safe, affordable places to be active (both indoor and outdoor facilities)</li> <li>· Physical activity rate</li> <li>· Smoking</li> <li>· Access to affordable chronic disease management services and resources</li> <li>· Proximity and access to affordable, healthy food</li> <li>· Healthy food consumption</li> <li>· Walkability</li> </ul>	<p><b>Mandatory Criteria</b></p> <ul style="list-style-type: none"> <li>2.5 Proximity to Services</li> <li>2.6 Preservation of and Access to Open Space for Rural/Tribal/Small Towns</li> <li>7.12 Active Design: Promoting Physical Activity within the Building</li> </ul> <p><b>Optional Criteria</b></p> <ul style="list-style-type: none"> <li>2.7 Preservation of and Access to Open Space</li> <li>2.8 Access to Public Transportation</li> <li>2.9 Improving Connectivity to the Community</li> <li>2.12 Access to Fresh, Local Foods</li> <li>2.13 LEED-ND Certification</li> <li>7.13 Active Design: Staircases and Building Circulation</li> <li>7.14 Interior and Outdoor Activity Spaces for Children and Adults</li> <li>7.15 Smoke-Free Building</li> </ul>
Cancer and Health Outcomes Related to Toxin Exposure (e.g., child development and learning, cognitive function)		<ul style="list-style-type: none"> <li>· Access to affordable healthy food and water</li> <li>· Exposure to toxins: indoor and outdoor</li> <li>· Indoor and outdoor water quality</li> <li>· Air quality</li> <li>· Access to safe, affordable places to be active</li> <li>· Healthy food consumption</li> <li>· Use of toxic/carcinogenic products (e.g., for cleaning)</li> <li>· Access to affordable health screening and treatment</li> </ul>	<p><b>Mandatory Criteria</b></p> <ul style="list-style-type: none"> <li>3.1 Environmental Remediation</li> <li>3.5 Surface Stormwater Management</li> <li>6.1 Low/No VOC Paints, Coatings and Primers</li> <li>6.2 Low/No VOC Adhesives and Sealants</li> <li>7.10 Integrated Pest Management</li> <li>8.1 Building O&amp;M Manual and Plan</li> <li>8.3 Occupant Manual</li> </ul> <p><b>Optional Criteria</b></p> <ul style="list-style-type: none"> <li>2.11 Brownfield Site or Adaptive Reuse Building</li> <li>2.12 Access to Fresh, Local Foods</li> <li>6.5 Certified, Salvaged and Engineered Wood Products</li> <li>7.15 Smoke-Free Building</li> </ul>
Mental Health (depression, anxiety, etc.)		<ul style="list-style-type: none"> <li>· Views of nature (e.g., natural lighting, green spaces)</li> <li>· Noise levels</li> <li>· Crime levels</li> <li>· Access to employment and educational resources</li> <li>· Amount and quality of sleep</li> <li>· Social cohesion</li> <li>· Access to affordable mental health providers</li> </ul>	<p><b>Mandatory Criteria</b></p> <ul style="list-style-type: none"> <li>2.5 Proximity to Services</li> <li>2.6 Preservation of and Access to Open Space for Rural/Tribal/Small Towns</li> </ul> <p><b>Optional Criteria</b></p> <ul style="list-style-type: none"> <li>2.7 Preservation of and Access to Open Space</li> <li>7.14 Interior and Outdoor Activity Spaces for Children and Adults</li> </ul>

---

## RECOMMENDATIONS

The following strategies emphasize the connections between physical design and health, as well as the positive health benefits of supportive occupant services and programming to promote health education and healthy behaviors. These strategies support consideration of health throughout the life cycle of a project, from initial design to evaluation and monitoring of the project's impacts on health over time.

- Project teams can rely on existing local health data and resources (see examples in the Resources section of this criterion) to identify the most prevalent health challenges affecting the proposed project's surrounding community. Whenever possible, project teams should use neighborhood-level data specific to the communities most likely to be directly affected by the proposed project. Neighborhood-level data may be available, and project teams could consult their local health department (or other local partners, such as hospitals and schools) for available sources. For example, local health departments or nonprofit hospitals and health systems may be able to provide data from community health needs assessments. When neighborhood-level sources are not available, project teams can rely on county-level resources such as the County Health Ranking website ([www.countyhealthrankings.org](http://www.countyhealthrankings.org)) and /or other databases listed within the Resources section of this criterion.
- Conduct community meetings and/or tenant surveys to engage and better understand the perspectives of community stakeholders as well as to collect data directly from them regarding the health-related issues that matter most to them. Community stakeholders may include: community members who live in or may be served directly by the project; individuals who live, work or learn in the neighborhood surrounding the project; and those who provide services or programming in the building or in the neighborhood surrounding the project. This may be accomplished by adding health-focused conversations to community meetings already scheduled as part of the project planning and design process. Local public health professionals may also be well-positioned to support project teams in conducting these conversations. Project teams should strive to collect information from a diverse group of community stakeholders to ensure consideration of a range of perspectives. In particular, engagement should focus on including individuals and groups that may be directly affected by the project and/or that may not typically be involved in the planning and design process.
- Consider partnering with local health providers and public health professionals, such as staff from local or state health departments, to identify priority health issues. Public health professionals monitor, address and prevent health concerns at a community or population level, rather than at an individual level. In most communities, the local or state health department is the primary organization that employs public health professionals. However, many colleges and universities have public or community health programs that also employ and train public health professionals. In addition, there is an increasing number of public health nonprofit organizations such as state or regional public health institutes that could help support a project. Examples of local health providers include those who are providing direct care to individuals. This may or may not include people with medical training, such as nurses, physician assistants and physicians.

## RESOURCES

### Connections between the built environment and health outcomes

Project teams can learn more about the connections between the built environment and health outcomes through resources such as these and others:

- The Robert Wood Johnson Foundation Social Determinants of Health Series provides issue briefs on connections between neighborhoods and health, housing and health, and social factors and health behaviors. [www.rwjf.org/en/search-results.html?cs=content\\_series%3Awhat-shapes-health&s=0](http://www.rwjf.org/en/search-results.html?cs=content_series%3Awhat-shapes-health&s=0)
- The Build Healthy Places Network provides access to research and best-practice models in connecting community development and health efforts. [www.buildhealthyplaces.org/network\\_resources/](http://www.buildhealthyplaces.org/network_resources/)
- The Urban Land Institute’s “Intersections: Health and the Built Environment” report explores the relationships between health and the way buildings and neighborhoods are built. [uli.org/wp-content/uploads/ULI-Documents/Intersections-Health-and-the-Built-Environment.pdf](http://uli.org/wp-content/uploads/ULI-Documents/Intersections-Health-and-the-Built-Environment.pdf)
- The Centers for Disease Control and Prevention, Guide to Community Preventive Services summarizes evidence of community-level programs and policies to improve health and prevent disease based on a scientific systematic review process. [www.thecommunityguide.org](http://www.thecommunityguide.org)
- Active Design Guidelines, 2010. [centerforactivedesign.org/guidelines/](http://centerforactivedesign.org/guidelines/)

### Neighborhood or community-level health data sets

Some jurisdictions provide readily available health data at the neighborhood level. Here are examples:

- County Health Data Resources for Iowa Counties. [idph.iowa.gov/Portals/1/Files/CHNAHIP/County%20Health%20Data%20Resources.pdf](http://idph.iowa.gov/Portals/1/Files/CHNAHIP/County%20Health%20Data%20Resources.pdf)
- Iowa Public Health Data. [idph.iowa.gov/PublicHealthData](http://idph.iowa.gov/PublicHealthData)
- Project teams can also contact local or state health departments to inquire about the availability of neighborhood-level health data. Additionally, project teams can consult the Centers for Disease Control and Prevention’s guidance on “Creating a Health Profile of Your Neighborhood.” This document outlines the basic steps and provides online resources for creating a neighborhood health profile. [www.cdc.gov/healthyplaces/toolkit/sources\\_of\\_health\\_data.pdf](http://www.cdc.gov/healthyplaces/toolkit/sources_of_health_data.pdf)
- Community Commons: This is an interactive mapping, data and networking tool to support organizations in their efforts to create healthy, sustainable and equitable communities. [www.communitycommons.org](http://www.communitycommons.org)
- County Health Rankings: The County Health Rankings use county-level measures from a variety of state and national data sources to assess and rank the population health of nearly all counties in the U.S. This website allows users to view the rankings and to explore and download data, including statistics on length of life, self-reported general health, and a subset of health influences. [www.countyhealthrankings.org](http://www.countyhealthrankings.org)
- Community Action Partnership: This website provides selected demographic, employment, educational attainment, income, housing, nutrition and health care indicators at the county and state levels and can be summarized using online tables and charts. [communityactionpartnership.com](http://communityactionpartnership.com)
- Centers for Disease Control, Field Guide for Community Needs Assessment: This document details the steps of conducting a community needs assessment. [www.cdc.gov/globalhealth/healthprotection/fetp/training\\_modules/15/community-needs\\_fguidelines\\_final\\_09252013.pdf](http://www.cdc.gov/globalhealth/healthprotection/fetp/training_modules/15/community-needs_fguidelines_final_09252013.pdf)

- University of Kansas, Work Group for Community Health and Development, “The Community Toolbox, Chapter 7. Conducting Needs Assessment Surveys”: This online toolbox describes the process and provides examples of conducting a needs assessment survey to identify important needs of the community. [ctb.ku.edu/en/table-of-contents/assessment/assessing-community-needs-and-resources/conducting-needs-assessment-surveys/main](http://ctb.ku.edu/en/table-of-contents/assessment/assessing-community-needs-and-resources/conducting-needs-assessment-surveys/main)
- Robert Wood Johnson Foundation — DataHub: This website allows users to customize state-level data on key health and health care topics and visualize facts and figures. [www.rwjf.org/en/library/collections/better-data-for-better-health.html](http://www.rwjf.org/en/library/collections/better-data-for-better-health.html)
- Health Statistics You Can Visualize, Customize & Share, Centers for Disease Control, State and Local Tracking Portals: This website provides links to health and environmental data from 23 states and one city. [ephtracking.cdc.gov/showStateTracking.action](http://ephtracking.cdc.gov/showStateTracking.action)
- National Network of Public Health Institutes — Community Health Improvement: This website provides webinars, case studies and resources regarding community health assessments and community health improvement tools and techniques. [nnphi.org/focus-areas-service/](http://nnphi.org/focus-areas-service/)

## 1.2B OCCUPANT HEALTH AND WELL-BEING: HEALTH ACTION PLAN

### OPTIONAL / 12 POINTS

#### REQUIREMENTS

At pre-design and continuing throughout the project life cycle (design, construction, operations), collaborate with public health professionals and community stakeholders to assess, identify, implement and monitor achievable actions to enhance health-promoting features of the project and minimize features that could present risks to health. As compared to satisfying the requirements of Criterion 1.2a, compliance with this criterion requires a more rigorous association with public health professionals and more robust follow-up actions. Specifically, comply with Step 1 and Step 2 outlined here:

#### Step 1: Create a Health Action Plan

##### *Purpose*

Conduct additional research on resident health factors identified in 1.2a. Using public health data and community input, characterize how the project may impact — both positively and negatively — social, environmental and economic outcomes for residents and, in turn, promote or produce unintended negative consequences for health. Based on the best available evidence, prioritize actions that will protect and promote health in response to these potential social, environmental and economic impacts.

##### *Participants*

The primary participants are those on the project team, which will be guided by input from community stakeholders likely to be affected by the project, as well as technical assistance from public health professionals (ideally those with Health Impact Assessment [HIA] expertise). As described in Criterion 1.2a, community stakeholders may include community members who live in or may be served directly by the project; individuals who live, work or learn in the neighborhood surrounding the project; and those who provide services or programming in the building or in the neighborhood surrounding the project. Public health professionals may include those with expertise in public health or community health. Faculty or graduate students of public health programs, and staff of local health departments, public health institutes and/or community-based public health organizations are suggested examples of partners. See Resources for more suggested contacts.

### *Process*

Gather information and solicit feedback regarding critical health aspects affecting the community (including social, environmental and economic factors that impact health). Hold a series of meetings with key stakeholders, including public health professionals and community stakeholders to facilitate collaboration and develop a plan for analyzing the project's potential impacts on health, including:

- Conduct a scoping conversation with public health professionals and community stakeholders to identify the project's potential connections to health. Prior to this scoping conversation, project teams could review and familiarize themselves with the connections between building design, construction and operation; neighborhood characteristics; and health. See the Resources section in Criterion 1.2.a for information about these connections to health.
- Gather evidence (including existing data sources, new qualitative research and/or public hearings, meetings with public health professionals) about the project's potential connections to health and the baseline health of the community groups that could be impacted by the project.
- Outline the distribution of health issues among impacted communities and describe how different groups may be disproportionately impacted by the project (positively and negatively).
- Identify actions that could be taken to enhance health-supportive features of the project and those that could minimize potential health risks. Identify actions that can be taken within the project's design, construction or operation that will promote health equity. As listed in Resources, Promoting Equity Through the Practice of Health Impact Assessment can provide guidance.
- Using the list of actions produced, prioritize actions to protect and promote health in consultation with public health professionals and community stakeholders. In identifying priority actions, project teams and stakeholders should use factors that include the actions' likelihood of having significant effects on health and equity, responsiveness to community concerns, and feasibility of implementation to guide the prioritization process. Teams should consider the extent to which the actions will address health impacts of higher concern as well as the feasibility of implementation (in terms of cost, resources, technical constraints, etc.). Teams should provide a rationale for the selected strategies, as shown in the sample table found in Recommendations.

### *Products*

- A description of key health issues (including social, environmental and economic factors) identified by stakeholders in the scoping conversation for assessing the project's connections to health. See Recommendations for a sample chart that captures this information.
- A description of how engaging public health professionals and community stakeholders informed the list of key health issues to be addressed by this project. Submit separately from sample chart seen in Recommendations.
- List (or asset map) of public health and community stakeholders involved. Submit separately from sample chart seen in Recommendations.
- List of potential actions to protect and promote health. See Recommendations for a sample chart that captures this information.
- List of selected interventions; description of reasons for implementing selected actions and rationale for not selecting the other identified potential interventions for implementation; and summary of how the selected actions may address health equity. See Recommendations for a sample chart that captures this information.

## Step 2: Project Implementation and Monitoring

### *Purpose*

Integrate the list of selected interventions and a plan for monitoring and evaluating your progress into the plan for project development.

### *Process*

- Document and demonstrate how the analysis in Step 1 informed building and site design decisions, including modifications that were made in response to the findings and recommended actions that were identified in the information-gathering and health action plan phases.
- Develop a monitoring plan with performance metrics to evaluate the project's impact on resident health throughout the project life cycle (design, construction and operations).

### *Product*

The plan should include:

- A summary of which modifications were made in response to the findings and recommended actions identified in the earlier phases. See Recommendations for a sample chart that captures this information.
- The performance metrics to be monitored. Include design metrics (metrics to determine how well the design team integrated the selected strategies into the project in a manner that will promote positive health outcomes), operations metrics (metrics that can be measured on a routine basis while the building is in operation to determine whether or not the building is performing as intended), and health metrics (metrics regarding resident health factors and, where possible, incidence or prevalence of key health outcomes in the resident and/or community population). See Recommendations for a sample chart that captures this information.
- Specific information on indicators, data sources, frequency, and roles and responsibilities for monitoring different information as per the sample chart in Recommendations in this section.
- Identify the individual or organization responsible for implementing and monitoring the selected strategy as well as the rate of how often the associated performance metrics will be monitored. See Recommendations for a sample chart that captures this information.

## **RATIONALE**

Health Impact Assessments (HIAs) identify the potential effects of a proposed policy, project or program and offer practical options for maximizing health benefits and minimizing health risks. The process outlined in Criterion 1.2b does not include all steps of an HIA, but builds upon core HIA elements to allow project teams to identify and address important health issues. This process facilitates the identification of ways to optimize a project's impacts on the health and engagement of key stakeholders, including public health experts and community stakeholders, throughout the project life cycle through a more cost-effective approach. To learn more about HIA, please reference the National Resource Council guidance on HIAs (see Resources section).

## RECOMMENDATIONS

### Step 1: Create a Health Action Plan

#### EXAMPLE OF PARTIAL PRODUCT FOR CRITERION 1.2B, STEP 1:

KEY HEALTH ISSUE AND POPULATION GROUP	POTENTIAL INTERVENTIONS	EXAMPLES OF STRATEGIES	WAS THIS STRATEGY ELECTED? (YES/NO)	IF SELECTED, INDICATE HOW THIS STRATEGY WILL BE IMPLEMENTED	RATIONALE FOR SELECTING OR REJECTING THE EXAMPLE STRATEGY
<b>High incidence of childhood asthma</b>	Eliminate or reduce use of potential asthmagens	Prioritize the specification of hard-surface flooring	Yes	Specification of linoleum for kitchens; cork flooring for bedrooms	High-impact strategy in terms of addressing health issue; also a flooring choice that reduces ongoing maintenance and replacement costs. Given the disparities in asthma rates by race, ethnicity and income in our community, this strategy will also help to address health equity.
<b>Above-average prevalence of childhood obesity</b>	Prioritize features that promote physical activity	Street infrastructure improvements to safely accommodate users of all ages, abilities and transportation modes	No	N/A	Our project team does not have the capacity to affect local transportation infrastructure
<b>Above-average prevalence of childhood obesity</b>	Prioritize features that promote physical activity	Playground	Yes	We will be including a 100-square-foot playground as part of our project	This feature will provide a local, safe space for the families living in our development to play and socialize. Otherwise, closest playspace is 2 miles from project; not easily accessible. Given the disparities in childhood obesity rates by race, ethnicity and income in our community, this strategy will also help to address health equity.

Project teams may also want to identify programming features you intend to provide to residents, such as nutritional classes, cooking courses, etc.



**Step 2: Implement and Monitor**

**Definitions**

*Potential Performance Metrics:* List of methods that could be used to evaluate the impact of the selected strategies on the population need.

*Design Metrics:* Metrics to determine how well the design team, at the design stage, integrated the selected strategies into the project in a manner that will promote positive health outcomes.

*Operations Metrics:* Metrics that can be measured on a routine basis while the building is in operation to determine whether or not the building is performing as intended.

*Health Metrics:* Metrics regarding resident health factors and, where possible, incidence or prevalence of key health outcomes in the resident and/or community population.

*Selected Performance Metrics:* List of the specific Potential Performance Metrics that will be implemented.

*Roles, Responsibilities and Responsible Individual(s) and /or Organization(s):* List of the roles and responsibilities necessary to measure the Selected Performance Metrics, including the specific individual and/or organization selected to fill that role and /or responsibility. Identify individual(s) or organization(s) that would be accountable to take action if any adverse results are found.

*Frequency:* The rate of how often the Selected Performance Metrics will be evaluated.

EXAMPLE OF PRODUCT FOR CRITERION 1.2B, STEP 2

INFORMATION IDENTIFIED IN STEP 1			NEW TABLE CELLS IN STEP 2			
POPULATION NEED	SELECTED INTERVENTION(S)	SELECTED STRATEGY	POTENTIAL PERFORMANCE METRICS	SELECTED PERFORMANCE METRICS	RESPONSIBLE INDIVIDUAL(S) AND/OR ORGANIZATION(S)	FREQUENCY
High incidence of childhood asthma	Eliminate or reduce use of potential asthmagens	Specification of linoleum for kitchens, cork flooring for bedrooms, etc.	<p><b>Design Metrics</b> No carpet is specified in the project plans and specs. All flooring materials specified are hard surfaces.</p> <p><b>Operations Metrics</b> Screen indoor air for presence of asthmagens</p> <p><b>Health Metrics</b> Incidence rate of acute asthma events</p>	<p><b>Design Metrics</b> No carpet is specified in the project plans and specs. All flooring materials specified are hard surfaces.</p> <p><b>Operations Metrics</b> Screen indoor air for presence of asthmagens</p> <p><b>Health Metrics</b> Incidence rate of acute asthma events</p>	<p><b>Design Metrics</b> Architect to certify that no carpet was utilized in the project design/ specifications. John Smith, ACME Inc., 123.456.7890</p> <p><b>Operations Metrics</b> Property manager will engage an IEQ consultant to measure formalde-hyde levels in air once each quarter. Jane Doe, Company Inc., 234.456.5678</p> <p><b>Health Metrics</b> Housing provider will annually collect self-reported rates of asthma incidents among residents and track them over the life of the project. Or, housing provider will work with local hospital or health system to track and monitor rates of admission and re-admission for asthma incidents. Johnny Rocket, XYZ Company, 456.678.6789</p>	<p><b>Design Metrics</b> To be certified on final plan set before construction starts</p> <p><b>Operations Metrics</b> To be measured once each quarter</p> <p><b>Health Metrics</b> Annual survey</p>



INFORMATION IDENTIFIED IN STEP 1			NEW TABLE CELLS IN STEP 2			
POPULATION NEED	SELECTED INTERVENTION(S)	SELECTED STRATEGY	POTENTIAL PERFORMANCE METRICS	SELECTED PERFORMANCE METRICS	RESPONSIBLE INDIVIDUAL(S) AND/OR ORGANIZATION(S)	FREQUENCY
Above average prevalence of childhood obesity	Prioritize physical activity promoting features; add outdoor lighting to playgrounds to allow use for more hours; add bike racks and storage	Add lighting to exterior park/ playground areas	<p><b>Design Metrics</b> Specific type of light used</p> <p><b>Operations Metrics</b> Area is well lit during all hours of operation</p> <p><b>Health Metrics</b> Self-reported rates of physical activity among residents; frequency of events/ opportunities for physical activity and participation rates in these events; operations staff monitor playground use by keeping tally</p>	<p><b>Design Metrics</b> Specified lighting for park/ playground areas complies with Criterion 5.5 as well as foot candle recommendations</p> <p><b>Operations Metrics</b> Lighting density</p> <p><b>Health Metrics</b> Frequency of events and opportunities for physical activity (e.g., “community field day” or walking groups) and associated participation rates</p>	<p><b>Design Metrics</b> Architect to certify that specs include appropriate lighting fixtures. John Smith, ACME Inc., 123.456.7890</p> <p><b>Operations Metrics</b> Maintenance technician to measure lighting density once each quarter. Jane Doe, Company Inc., 234.456.5678</p> <p><b>Health Metrics</b> Residential Services Coordinator Beth Smith 123.456.7890</p>	<p><b>Design Metrics</b> To be certified on final plan set before construction starts</p> <p><b>Operations Metrics</b> To be measured once each quarter</p> <p><b>Health Metrics</b> Quarterly tracking of events and number of participants</p>

**Transparency**

- Share your Step 2 table through the Green Building Information Gateway (gbg.org) and the Health Impact Project (healthimpactproject@pewtrusts.org).
- Produce an acknowledgment page or letter(s) of support from public health professionals and community stakeholders. Receive documentation from community stakeholders regarding their involvement in the identification and prioritization of actions to protect and promote health (completed in Step 2) and their level of support for the health action plan. Note that project teams need to obtain consent from any community and team members to be listed in the acknowledgments page.
- Note where health-related items have been incorporated into project documentation, including plans and specifications.

**RESOURCES**

- Data sources for measuring baseline health: Provided in the Resources section of Criterion 1.2a. See also the Human Impact Partners resources listed below.
- The American Planning Association and the National Association of County and City Health Officials webinar, “Planning for Healthy Places with Health Impact Assessments”: This online course explains the value of and the steps involved in conducting an HIA. [www.planning.org/nationalcenters/health/planninghia/](http://www.planning.org/nationalcenters/health/planninghia/)
- The Mariposa Healthy Living Toolkit: This toolkit provides a guide for assessing the health conditions of residents and identifying opportunities to improve health during community redevelopment projects. [mithun.com/project/mariposa-healthy-living-initiative/](http://mithun.com/project/mariposa-healthy-living-initiative/)

- Health Impact Project’s interactive map of HIAs: This interactive map allows users to sort and analyze data on completed and in-progress HIAs in the U.S.  
[www.pewtrusts.org/en/projects/health-impact-project](http://www.pewtrusts.org/en/projects/health-impact-project)
- The Surgeon General’s National Prevention Strategy: Healthy Communities factsheet: This document outlines actions that different organization types can take to support healthy and safe community environments.  
[www.surgeongeneral.gov/priorities/prevention/strategy/national-prevention-strategy-fact-sheet.pdf](http://www.surgeongeneral.gov/priorities/prevention/strategy/national-prevention-strategy-fact-sheet.pdf)
- Guidance and Best Practices in Stakeholder Participation in HIAs: This document provides recommended strategies for collaborating with stakeholders.  
[www.pewtrusts.org/en/projects/health-impact-project](http://www.pewtrusts.org/en/projects/health-impact-project)
- Promoting Equity through the Practice of HIA: This document highlights strategies for and case examples of promoting equity through Health Impact Assessments.  
[hiasociety.org/resources/Documents/HIA-Promoting-Equity.pdf](http://hiasociety.org/resources/Documents/HIA-Promoting-Equity.pdf)
- Human Impact Partners: [www.humanimpact.org/capacity-building/hia-tools-and-resources/](http://www.humanimpact.org/capacity-building/hia-tools-and-resources/)
- Some suggested tools and resources for your use are:
  - *Roles for Collaborators*: This document provides examples of different partners that might be involved in a Health Impact Assessment and their roles.
  - *Rapid HIA Model*: This document provides guidance for conducting a Health Impact Assessment within a short timeline, while maintaining a high level of stakeholder engagement.
  - *Data sources table*: This table outlines data sources that may be useful in a Health Impact Assessment.
- Mithun Cultural Audit Tool: The Cultural Audit attempts to collect diverse community input from a broad constituency and helps to form a more inclusive picture of the community. [www.chausa.org/docs/default-source/health-progress/culture-audits---a-tool-for-change-pdf.pdf?sfvrsn=0/](http://www.chausa.org/docs/default-source/health-progress/culture-audits---a-tool-for-change-pdf.pdf?sfvrsn=0/)
- National Research Council Improving Health in the United States: The Role of Health Impact Assessment and related brief: These documents provide an overview and a definition of “health impact assessment,” examples of methods for analyzing potential health impacts of a project, and best practices for monitoring the project’s impacts on health. [www.ncbi.nlm.nih.gov/pubmed/22379655](http://www.ncbi.nlm.nih.gov/pubmed/22379655)
- Minimum Elements of Health Impact Assessment (v3): This document describes the essential elements of and standards for a Health Impact Assessment.  
[healthimpactassessment.blogspot.com/2014/09/minimum-elements-and-practice-standards.html](http://healthimpactassessment.blogspot.com/2014/09/minimum-elements-and-practice-standards.html)

## 1.3A RESILIENT COMMUNITIES: DESIGN FOR RESILIENCE NEW CONSTRUCTION AND SUBSTANTIAL REHAB ONLY

### MANDATORY

### REQUIREMENTS

Given your project building type, location and expected resident population or building user, identify a project characteristic that would most likely impact your project’s ability to withstand an unexpected weather event or loss of power. Select at least one of the optional Design for Resilience Criteria listed below that would help mitigate that impact, and incorporate this within your project plans and design. Include a short narrative providing your rationale for selecting this criterion above the others.

#### Design for Resilience Criteria

- 1.3b: Resilient Communities: Multi-Hazard Risk / Vulnerability Assessment\*
- 2.10: Passive Solar Heating/Cooling
- 3.5: Surface Stormwater Management (only rehab projects can choose this option)
- 4.2: Advanced Water Conservation [Must achieve at least 3 points if selecting this criterion]
- 4.5: Water Reuse [Must achieve at least 3 points if selecting this criterion]
- 5.2a: Additional Reductions in Energy Use
- 5.2b: Advanced Certification: Nearing Net Zero
- 5.8a: Resilient Energy Systems: Floodproofing\*
- 5.8b: Resilient Energy Systems: Islandable Power\*

\*These criteria provide a project with the capacity to respond in the near-term to emergencies. These emergency response items are critical for addressing immediate resiliency needs. The other criteria listed here enhance overall project efficiency and performance, creating a more resilient project in more general terms.

## *RATIONALE*

Per the Resilient Design Institute, resilience is the capacity to adapt to changing conditions and to maintain or regain functionality (“bounce forward”) and vitality in the face of stress or disturbance. It is the capacity to bounce back after a disturbance or interruption of some sort. At various levels — individuals, households, communities and regions — through resilience we can maintain livable conditions in the event of natural disasters, loss of power or other interruptions in normally available services. Relative to climate change, resilience involves adaptation to the wide range of regional and localized impacts that are expected with a warming planet: more intense storms, greater precipitations, flooding, longer and more severe droughts in some areas, wildfires, warmer temperatures and power outages. Resilient design is the intentional design of buildings, landscapes, communities and regions in response to these vulnerabilities.

## *RECOMMENDATIONS*

- Note that while the criteria listed in the table above are those explicitly designed to address resilience, many other criteria are also meaningful in terms of contributing to a project’s capacity to withstand a severe interruption. For instance, compliance with optional Criterion 5.7a Photovoltaic/Solar Hot Water Ready would result in a building better prepared to adjust per changing project needs in the future.
- To foster social resilience in a multifamily property, consider co-locating the features listed above. For instance, a community room in a multifamily property could become a hub during an emergency, including postings of community information by management, serving as a gathering spot for neighbors, providing access to potable water during emergencies, being supplied by islandable power systems for critical services, and including charging stations for residents and community members.
- Enterprise’s Multifamily Resilience Manual includes more than a dozen strategies and specific guidance for building property resilience in the event of an emergency. Consider incorporating one or more of these measures into your property.

## RESOURCES

- Green Building and Climate Resilience: Understanding Impacts and Preparing for Changing Conditions, University of Michigan; U.S. Green Building Council; 2011. This document identifies climate-related vulnerabilities at the regional level and prioritizes design, construction and operation strategies that will increase resilience and facilitate climate adaptation.  
[www.usgbc.org/Docs/Archive/General/Docs18496.pdf](http://www.usgbc.org/Docs/Archive/General/Docs18496.pdf)
- Enterprise’s Multifamily Resilience Manual: [www.enterprisecommunity.org/resources/ready-respond-strategies-multifamily-building-resilience-13356](http://www.enterprisecommunity.org/resources/ready-respond-strategies-multifamily-building-resilience-13356)
- Building Resiliency Task Force Full Report, June 2013, Urban Green: Provides resiliency-related recommendations for communities and buildings.  
[www.urbangreencouncil.org/content/projects/building-resiliency-task-force](http://www.urbangreencouncil.org/content/projects/building-resiliency-task-force)

## 1.3B RESILIENT COMMUNITIES: MULTI-HAZARD RISK / VULNERABILITY ASSESSMENT OPTIONAL | 15 POINTS

### REQUIREMENTS

Carry out a Vulnerabilities Assessment and implement building elements designed to enable the project to adapt to, and mitigate, climate impacts given the project location, building /construction type, and population expected to use the building. Your Vulnerabilities Assessment should prioritize evaluation of issues (e.g., wildfires, flooding, etc.) identified in the state or county hazard mitigation plan for which your project is located. Implement strategies to address at least the top three risk factors identified for your project. Also ensure that these measures are incorporated in response to Criterion 8.2 Emergency Management Manual.

### RATIONALE

Creating community facilities and affordable housing projects that will perform well during natural disasters requires careful planning. The exercise of assessing vulnerabilities and creating a plan to mitigate appropriate risks will result in greater focus on this issue. Engaging in this exercise during the integrative design process will allow for input from a variety of stakeholders and incorporation of measures that enhance resilience throughout the project design and construction documents.

### RECOMMENDATIONS

- Hold a series of facilitated charrettes and community meetings focused explicitly on identifying how the issues identified in your project’s state or county hazard mitigation plan apply to your project and users of the proposed project
- Identify solutions appropriate for your project, evaluate how these strategies overlap with the other criteria selected for your project, and determine best means of implementation.

---

## RESOURCES

- FEMA's hazard mitigation planning resources include a Mitigation Planning Handbook, guidelines for Sustainability in Mitigation Planning, Planning Advisory Service Reports, and examples of Mitigation Activities. [www.fema.gov/hazard-mitigation-planning-resources](http://www.fema.gov/hazard-mitigation-planning-resources)
- The National Hazard Mitigation Association (NHMA): Promotes natural hazard risk reduction and climate adaptation through planning, adaptation and mitigation. The NHMA promotes steps to reduce the risk and consequences of natural events with a special emphasis on protecting the most vulnerable populations in our communities. [nhma.info](http://nhma.info)
- The Built Environment Coalition (BEC): Develops analytical approaches, methodologies and tools to help communities and organizations identify opportunities to improve their built environment and make informed decisions on potential investments. [www.builtenvironmentcoalition.org](http://www.builtenvironmentcoalition.org)
- The Federal Alliance for Safe Homes (FLASH): The country's leading consumer advocate for strengthening homes and safeguarding families from natural and manmade disasters. [www.flash.org](http://www.flash.org)
- FEMA Building Vulnerability Assessment Checklist may be used as a screening tool for preliminary design vulnerability assessment. [www.fema.gov/media-library-data/20130726-1524-20490-4937/fema452\\_a.pdf](http://www.fema.gov/media-library-data/20130726-1524-20490-4937/fema452_a.pdf)
- California Association of Health Facilities Hazard Vulnerability Worksheet may be used as a template to score and assess your project for potential mitigative actions that can reduce identified vulnerabilities. [www.calhospitalprepare.org/hazard-vulnerability-analysis](http://www.calhospitalprepare.org/hazard-vulnerability-analysis)

INTRODUCTION CRITERIA  
CHECKLIST  
1 INTEGRATIVE DESIGN  
2 **LOCATION +  
NEIGHBORHOOD FABRIC**  
3 SITE IMPROVEMENTS  
4 WATER CONSERVATION  
5 ENERGY EFFICIENCY  
6 MATERIALS  
7 HEALTHY LIVING  
ENVIRONMENT  
8 OPERATIONS,  
MAINTENANCE +  
OCCUPANT  
ENGAGEMENT  
APPENDIX

## LOCATION + NEIGHBORHOOD FABRIC

LOCATING A PROJECT WITHIN AN EXISTING NEIGHBORHOOD AND IN CLOSE PROXIMITY TO INFRASTRUCTURE, TRANSPORTATION AND SERVICES ENCOURAGES MORE RESOURCE-EFFICIENT DEVELOPMENT OF LAND, REDUCES DEVELOPMENT COSTS, CONSERVES ENERGY AND ADDS TO THE VITALITY OF THE OVERALL COMMUNITY.

## 2.1 SENSITIVE SITE PROTECTION

*SEE EXEMPTIONS IN CRITERIA*

### MANDATORY

#### *REQUIREMENTS*

Protect significant tree and remnant landscape ecologies (may require a tree survey). Do not locate new projects, including buildings, built structures, roads or parking areas, on portions of sites that meet any of the following provisions:

1. Land within 100 feet of wetlands, including isolated wetlands or streams. Maintain or establish riparian buffer using native vegetation where possible. Bike and foot paths are allowed if at least 25 feet from the wetlands boundary.
2. Land on slope greater than 15%.
3. Land with prime soils, unique soils or soils of state significance per USDA designations.
4. Public parkland.
5. Land that is specifically identified as an existing habitat for any species on federal or state threatened or endangered lists.
6. Land that is within the Special Flood Hazard Areas (SFHA) as identified by FEMA on the Flood Insurance Rate Map.
7. Land outside the corporate limits of a municipality.

#### *EXEMPTIONS*

- Projects on previously developed sites are exempt from provision 1 above.
- Infill sites are exempt from provisions 2 and 3 above. (See Glossary for detail on what can be classified as an infill site.)
- Infill projects that are designated to meet the American Society of Civil Engineers ASCE 24 Flood Resistant Design and Construction Standard are exempt from provision 6 above.

#### *RATIONALE*

Proper site selection avoids damage to or loss of fragile and scarce environmental resources. It also reduces the risk of building damage from flooding, which is likely to be more frequent and more severe with the advent of changing weather patterns.

## RESOURCES

- Iowa Threatened and Endangered Species List: [www.iowadnr.gov/Conservation/lowas-Wildlife/Threatened-and-Endangered](http://www.iowadnr.gov/Conservation/lowas-Wildlife/Threatened-and-Endangered)
- U.S. Fish and Wildlife Service, Endangered Species Database: [www.fws.gov/Endangered/](http://www.fws.gov/Endangered/)
- U.S. Fish and Wildlife Service, National Wetlands Inventory: [www.fws.gov/wetlands/](http://www.fws.gov/wetlands/)
- American Society of Civil Engineers (ASCE), ASCE 24-05 Flood Resistant Design and Construction (2010): [www.fema.gov/media-library/assets/documents/14983?id=3515](http://www.fema.gov/media-library/assets/documents/14983?id=3515)
- U.S. Department of Agriculture, Natural Resources Conservation Service's Web Soil Survey: [websoilsurvey.nrcs.usda.gov/app/](http://websoilsurvey.nrcs.usda.gov/app/)
- Federal Emergency Management Agency (FEMA), FEMA's Flood Map Service Center: [msc.fema.gov/portal](http://msc.fema.gov/portal)

## 2.2 CONNECTIONS TO EXISTING DEVELOPMENT AND INFRASTRUCTURE

### MANDATORY

#### REQUIREMENTS

Locate the project on a site that has access to existing roads, water, sewers and other infrastructure within or contiguous to (having at least 25% of the perimeter bordering) existing development.

Connect the project to the pedestrian grid by creating new or enhancing existing sidewalks or other all-weather pathways to link the project to public spaces, open spaces and adjacent development.

Do not build on tracts of land that require installing a sanitary sewer line or water supply extension of 2,500 feet or more from the property line of the tract being developed.

#### RATIONALE

Locating a project within an existing neighborhood and in close proximity to infrastructure encourages more resource-efficient development of land, reduces development costs, conserves energy, adds to the vitality of the overall community, and safeguards a community during significant weather events. Ensuring that pedestrian and cycling infrastructure is included encourages safe, active transportation, which can improve health by significantly increasing daily physical activity.

#### RECOMMENDATIONS

- Provide enhanced pedestrian crossings at intersections using elements such as curb extensions, medians, crosswalk count-down clocks, daylighting, street treatments (e.g., different color or texture pavement in crosswalks) or sidewalk expansion. On streets with large blocks, consider mid-block pedestrian crossings.
- Dedicated pedestrian and bicycle paths are important even on dead-end streets.
- Design engaging and safe sidewalk experiences appropriate for expected pedestrian flows and uses.

## RESOURCES

- Urban Street Design Guide: <https://nacto.org/publication/urban-street-design-guide/>
- Iowa Complete Streets Resources and Model Policy: [dmampo.org/complete-streets](http://dmampo.org/complete-streets)
- Task Force on Community Preventive Services. The Community Guide — What Works to Promote Health. [www.thecommunityguide.org/pa/environmental-policy/communitypolicies.html](http://www.thecommunityguide.org/pa/environmental-policy/communitypolicies.html)
- Center for Active Design: The Center for Active Design maintains an urban design checklist that includes best practices for sidewalk design to encourage their vibrant use, including features like trees, lighting and wayfinding. [centerforactivedesign.org](http://centerforactivedesign.org)
- Smart Growth America: Complete Streets. [www.smartgrowthamerica.org/complete-streets](http://www.smartgrowthamerica.org/complete-streets)

## 2.3 COMPACT DEVELOPMENT

### OPTIONAL | 25 POINTS

#### REQUIREMENTS

##### FOR RESIDENTIAL PROJECTS

The Project architect or designer must complete the density calculation as defined below and certify its correctness. The project applicant must provide documentation from the applicable local jurisdiction indicating that the applicable density requirements provided below are permitted on the project site. The minimum net density for new construction must be:

- 6 units per acre for detached or semi-detached houses;
- 10 for townhomes; and
- 15 for apartments.

Net density is measured by taking the total dwelling units after construction, divided by the acreage of the entire tract down to one decimal point, minus dedicated acreage of public street rights of way, riparian and wetland buffers, and open space that has been dedicated through a conservation program, flood plains and remnant landscapes.

##### FOR COMMERCIAL PROJECTS

The Project architect or designer must complete the density calculation as defined below and certify its correctness. The project applicant must provide documentation from the applicable local jurisdiction indicating that the applicable density requirements provided below are permitted on the project site. The minimum floor-area ratio (FAR) for new construction must be 0.5.

The floor-area ratio (FAR) is the density of nonresidential land use, exclusive of parking, measured as the total nonresidential building floor area divided by the total buildable land area available for nonresidential structures. For example, on a site with 10,000 square feet of buildable land area, an FAR of .5 would be 5,000 square feet of building floor area. On the same site, a FAR of 1.5 would be 15,000 square feet.

##### FOR MIXED USE PROJECTS WITH COMMERCIAL AND RESIDENTIAL

Mixed use projects containing both residential and non-residential uses may choose either density option above.

## RATIONALE

Compact development encourages more resource-efficient development of land, reduces project cost, conserves energy and supports demand for other infrastructure such as public transportation and commercial development. Compact development also correlates with walking behavior and physical activity through active transportation. To the extent that communities want to foster safe, active transportation and a healthy lifestyle, compact development is critical to success.

## RESOURCES

- Congress for the New Urbanism provides tools and resources for promoting walkable, neighborhood-based development as an alternative to sprawl. [www.cnu.org](http://www.cnu.org)
- Smart Growth Network: This website outlines smart growth principles, provides a guide through smart growth terms and technical concepts, and hosts a searchable catalog of reports, websites, tools and case studies. [www.smartgrowth.org](http://www.smartgrowth.org)
- Urban Land Institute (ULI) promotes the responsible use of land to enhance the total environment. ULI's online bookstore includes numerous publications regarding compact and higher-density development. [www.uli.org](http://www.uli.org)

## 2.4 COMPACT DEVELOPMENT

### OPTIONAL | 5 POINTS

#### REQUIREMENTS

##### FOR RESIDENTIAL PROJECTS

Calculate density as defined under 2.3, Compact Development, and increase average minimum density for new construction to meet or exceed the following guidelines:

- 7 units per acre for detached or semi-detached
- 12 units per acre for town homes
- 20 units per acre for apartments

##### FOR COMMERCIAL PROJECTS

The Project architect or designer must complete the density calculation as defined below and certify its correctness. The project applicant must provide documentation from the applicable local jurisdiction indicating that the applicable density requirements provided below are permitted on the project site. The minimum floor-area ratio (FAR) for new construction must be 0.8.

##### FOR MIXED USE PROJECTS WITH COMMERCIAL AND RESIDENTIAL

Mixed use projects containing both residential and non-residential uses may choose either density option above.

## RATIONALE

See Rationale for Criterion 2.3.

## RESOURCES

See Resources for Criterion 2.3.

## 2.5 PROXIMITY TO SERVICES

### MANDATORY REQUIREMENTS

- Locate the project within a 0.25-mile walk distance of at least two, or a 0.5-mile walk distance of at least four, services.
- Each “service” type may not be counted more than twice. For example, if there are five banks within the required distance, only two may be counted.

RETAIL	AMENITIES	CIVIC AND COMMUNITY FACILITIES
Supermarket Other food store with produce Farmers market Clothing store or department store selling clothes Hardware store Pharmacy Other retail	Bank (with teller hours) Gym, health club, exercise studio Hair care Laundry, dry cleaner Restaurant, café, diner	Adult or senior care (licensed) Child care (licensed) Community or recreation center, potentially including performance space Cultural arts facility (museum, performing arts) Educational facility (including K–12 school, university, adult education center, vocational school, community college) Entertainment venue (theater, sports) Government office that serves public on-site Place of worship Medical clinic or office that treats patients Police or fire station Post office Public library Public park Social services center

List adapted from the LEED 2009 Neighborhood Development Rating System

### RATIONALE

Proximity to neighborhood services, including grocery stores, community centers, health services and some retail shops correlate highly with a physically healthy lifestyle. To the extent that communities want to foster active transportation and a healthy lifestyle, linking development to the types of destinations listed above is critical to success. Additionally, proximity and access to active recreation facilities such as parks, playgrounds and other exercise amenities are associated with increased physical activity and decreased weight.

Compact development encourages more resource-efficient development of land, reduces project costs and conserves energy. Additionally, it supports demand for other infrastructure such as public transportation and commercial development. Occupants of buildings with services within a close, safe, accessible physical proximity will fare better during natural disasters in the event of a loss of automobile access or other major events when gasoline and public transportation may be limited.

## RECOMMENDATIONS

- Use a context map to demonstrate that the center of the site is within the required walk distance of services.
- Walking paths and pedestrian street crossings should be safe and should include sidewalks, crosswalks and signals (urban areas).

## RESOURCES

- Google Maps offers a function to demonstrate walk distance. On Google Maps, go to “Directions” and select “Walk Directions” to obtain this information. [www.google.com/maps](http://www.google.com/maps)
- Safe Routes to School National Partnership: [www.saferoutespartnership.org](http://www.saferoutespartnership.org)
- Walkable Communities: [www.walkable.org](http://www.walkable.org)
- Walkable and Livable Communities Institute: [www.aarp.org/livable-communities/getting-around/](http://www.aarp.org/livable-communities/getting-around/)
- Partners for Livable Communities: [livable.org](http://livable.org)

## 2.6 PRESERVATION OF AND ACCESS TO OPEN SPACE FOR RURAL / TRIBAL / SMALL TOWNS

(RURAL AND SMALL TOWNS FOR THIS CRITERION ARE DEFINED AS LESS THAN 10,000 IN POPULATION)

### MANDATORY

#### REQUIREMENTS

##### Option 1

For projects on a site at least two acres in size, set aside a minimum of 10% (minimum of 0.2 acre) of the total project acreage as non-paved open space for use by all tenants.

OR

##### Option 2

Locate the project within a 0.25-mile walk distance of dedicated public non-paved open space that is a minimum of 0.75 acres.

*Note: For either option, land that is set aside for future development cannot be included as open space in these calculations.*

#### RATIONALE

Open space is more than just a land asset for development; it is an amenity that attracts the broader community. Access to safe open space and other natural resources improves quality of life, enhances opportunities for physical activity and social interaction, and provides the opportunity to better understand the importance of the natural environment.

## RECOMMENDATIONS

- Create a site plan with total acres and the number of acres of the proposed open space, and a narrative plan for security and maintenance for the preservation of the open space.
- When calculating open space, be sure to deduct buildings, private outdoor areas, streets and roadways from your total site area.
- Open spaces should be safe and designed to promote active use by residents. Features such as active bike and walking trails/paths, lighting, seating options, native plantings and recreation facilities to make open space a community amenity. Open spaces should complement the cultural preferences of the local population and accommodate people of all ages.

## RESOURCES

- Iowa Natural Heritage Foundation: [www.inhf.org/what-we-do](http://www.inhf.org/what-we-do)
- U.S. Environmental Protection Agency, Smart Growth and Open Space Conservation: [www.epa.gov/smartgrowth/openspace.htm](http://www.epa.gov/smartgrowth/openspace.htm)
- The Trust for Public Land: Creates parks and protects land for people, ensuring healthy, livable communities for generations to come: [www.tpl.org](http://www.tpl.org)
- The Trust for Public Land, ParkScore Index: A rating system developed to measure how well U.S. cities are creating parks: [parkscore.tpl.org](http://parkscore.tpl.org)

## 2.7 PRESERVATION OF AND ACCESS TO OPEN SPACE OPTIONAL | 6 POINTS MAXIMUM

### REQUIREMENTS

Set aside a percentage of non-paved open space for use by all residents.

PERCENTAGE OF OPEN SPACE SET ASIDE	NUMBER OF OPTIONAL POINTS
20%	2 points
30%	4 points
40% + submitted written statement of preservation/conservation policy for set-aside land (for 15 years)	6 points

Green Roofs can be used in open space calculations if the square footage is accessible to all residents. Land that is set aside for future development cannot be included as open space in these calculations.

### RATIONALE

See Rationale for Criterion 2.6.

### RECOMMENDATIONS

See Recommendations for Criterion 2.6.

### RESOURCES

See Resources for Criterion 2.6.

## 2.8 ACCESS TO PUBLIC TRANSPORTATION

### OPTIONAL | 8 OR 10 POINTS

#### REQUIREMENTS

Locate projects within a 0.5-mile walk distance of transit services (bus, rail) combined, constituting at least 20 or more transit rides per weekday, with some type of weekend ride option. *[8 points]*

For projects in communities with a population of less than 20,000, locate the project within a 5-mile distance of the following transit options: 1) vehicle share program; 2) dial-a-ride program; 3) employer vanpool; 4) park-and-ride; or 5) public-private regional transportation. *[8 points]*

For an additional *[2 points]*: Locate the project along dedicated bike trails or lanes that lead to transit services or stations within 3 miles.

#### RATIONALE

Projects located near transit reduce vehicle traffic and the need to own a car, thereby eliminating or lowering the costs of auto ownership. Transit use reduces related emissions of air pollutants and carbon dioxide. In addition, locating near high-frequency transit typically allows project users to access major employment centers, and can provide opportunities for increased physical activity through active transportation, improving health. Bicycle facilities can significantly increase the area served by public transit, as distances too long to walk are often easily accessible by bicycle.

#### RECOMMENDATIONS

- Use a context map to demonstrate that the center of the site is within the required walk distance of combined transit options that provide an adequate number of rides per weekday.
- Bike lanes are defined as a portion of the roadway that is designated by striping, signage and/or pavement markings for preferential or exclusive use by bicyclists.

#### RESOURCES

- Iowa DOT Office of Public Transit: [iowadot.gov/transit](http://iowadot.gov/transit)
- Iowa DOT Bike / Pedestrian Resources: [iowadot.gov/iowabikes](http://iowadot.gov/iowabikes)
- Reconnecting America: [www.reconnectingamerica.org](http://www.reconnectingamerica.org)
- Victoria Transportation Policy Institute: [www.vtppi.org](http://www.vtppi.org)
- Transportation for America: [t4america.org](http://t4america.org)

## 2.9 IMPROVING CONNECTIVITY TO THE COMMUNITY

### OPTIONAL | 2-8 POINTS

#### REQUIREMENTS

Improve access to community amenities through at least one of the measures below:

#### Improving Access

##### *Transit*

- Provide residents with discounted transportation passes for a period of at least 12-months. [2 points]
- Provide residents with free transportation passes for a period of at least 12-months. [3 points]

##### *Auto*

- Include car-share services (parking) on property. [1 point]
- Provide all eligible residents with discounted car-share memberships for a period of at least 12-months. [2 points]
- Provide a minimum of 50% of eligible residents with free car-share memberships for a period of at least 12-months. [3 points]

##### *Incentivize Biking Mobility*

- Provide outdoor bicycle racks that are accessible for visitors and residents. [1 point]
- Provide secure, lockable, sheltered and accessible bicycle storage. Provide one bicycle parking space for every two residential units. Post signage directing residents to bicycle parking areas and programs. [2 points]
- Provide bicycles and equipment (e.g., helmets, locks, tire pumps, maintenance equipment) for resident use. [3 points]
- Promote use of, and access to, one or more bicycle-share programs within 0.25-mile of the building. Bicycles need to be accessible to occupants at all hours. Maps to the nearest bike station should be posted in a visible location within a common area in the building and included in the Occupant Manual (Criterion 8.3). [1 point]
- Provide residents with discounted bicycle-share memberships. for a period of at least 12-months [2 points]
- Provide residents with free bicycle-share memberships for a period of at least 12-months. [3 points]

#### RATIONALE

Connections to adjacent development and public, open spaces promote recreational walking, biking and other healthy lifestyle choices, as well as promoting alternative means of commuting.

## RECOMMENDATIONS

- Pedestrian activity and improved safety should be encouraged when considering opportunities for biking, walking, driving and parking.
- Provide orientation materials and maps to the nearest bus, transit stations and car-share facilities (general orientation materials are acceptable for floating car-share services such as Car2go). Information about these amenities should be posted in a visible location in a common area in the building and included in the Occupant Manual (Criteria 8.3).
- Consider including a small amount of credit (\$10) for building users to try their local car-share service. Contact the car-share services to see if they would like to offer discount or credit to encourage use.
- Promote designs that encourage slow-speed, low-volume roadways, thereby enhancing walkers' and bikers' safety.
- Consider designing the building exterior and massing to encourage physical activity by maximizing variety, detail and continuity on the lower one-to-two floors of the building exterior; by providing multiple entries and maximum transparency; and by incorporating canopies and awnings into building façade.
- Consider using porous pavement for sidewalks and other paved surfaces to reduce stormwater runoff and the distribution of pollutants to streams, rivers and water bodies. Design sidewalks to distribute stormwater to open space for recharge and to prevent flooding.
- Conduct an assessment to determine most likely routes of pedestrian and bicycle use when laying out paved pathways/sidewalks from the project to the surrounding neighborhood. Build the pathways/sidewalks where there is visible evidence of pedestrian and bicycle use.
- To encourage pedestrian activity, minimize addition of mid-block vehicular curb cuts on streets with heavy foot traffic; construct curb extensions along sections of the sidewalk that tend to attract greater pedestrian congestion and that are close to pedestrian crossings.
- Incorporate street furniture such as benches, trash receptacles and bicycle racks to create an active streetscape.
- Install street features that have been shown to effectively calm traffic, including curb extensions, medians, roundabouts and raised speed reducers.

## RESOURCES

- Urban Street Design Guide: [nacto.org/publication/urban-street-design-guide](https://nacto.org/publication/urban-street-design-guide)
- NYC Departments of City Planning, Health and Mental Hygiene, and Design and Construction. Active Design Supplement: Shaping the Sidewalk Experience, 2013: [centerforactivedesign.org/sidewalks](https://centerforactivedesign.org/sidewalks)
- Robert Wood Johnson Foundation, Active Living Research: [centerforactivedesign.org/affordablehousingcosts](https://centerforactivedesign.org/affordablehousingcosts)
- Task Force on Community Preventive Services, The Community Guide — What Works to Promote Health: [www.healthypeople.gov/2020/tools-resources/evidence-based-resource/guide-community-preventive-services-what-works-promot-0](https://www.healthypeople.gov/2020/tools-resources/evidence-based-resource/guide-community-preventive-services-what-works-promot-0)
- Task Force on Community Preventive Services, The Community Guide — Street-Scale Urban Design Land Use Policies: [www.thecommunityguide.org/sites/default/files/PA-Street-Scale-Archive.pdf](https://www.thecommunityguide.org/sites/default/files/PA-Street-Scale-Archive.pdf)

## 2.10 PASSIVE SOLAR HEATING/COOLING

### OPTIONAL | 5 POINTS MAXIMUM

#### REQUIREMENTS

Design and build project with passive solar design, orientation and shading that meets the following guidelines. Documentation must include sun angles and a wall section showing compliance with the guidelines, and site plan indicating true north. Also include documentation of compliance with all guidelines noted below.

PROJECT TYPE	POTENTIAL POINTS	REQUIREMENTS
New Construction: Stand-alone building	5	Meet all guidelines
New Construction: Projects with multiple buildings	2	25% of the buildings meet all guidelines
	3	50% of the buildings meet all guidelines
	4	75% of the buildings meet all guidelines
	5	100% of the homes meet all guidelines
Rehabs: Moderate or Substantial	3	All new windows must comply with the windows guidelines by Climate Zone rehab projects (Guideline 3)
	2	All south-facing elevations must comply with shading guidelines (Guideline 4)

#### Guidelines

1. *Building orientation*: Elongate the building on an east–west axis with a minimum ratio of width to depth of 2:1 and orient the east–west axis of the building to be within 20 degrees of true east–west.
2. *Glazing*: The glazing area on the south-facing façade should be 30% greater than the sum of the glazing areas on the east-, west- and north-facing façades.
3. *Glazing type*: Provide windows with U-values of 0.25 and solar heat gain coefficients (SHGC) of 0.50 by orientation
4. *Shading*: For south-facing windows, 50 percent of the window needs to be shaded by June 21.

#### RATIONALE

The use of passive solar energy through design minimizes reliance on mechanical heating, lowers the cooling load, and provides more residents with access to daylight. Passive solar heating and cooling-load-avoidance strategies become critically important during extended power outages or interruptions in heating fuel.

## RECOMMENDATIONS

- Interior spaces requiring the most lighting, heating and cooling should be along the south face of the building.
- Include a narrow floor plate (less than 40 feet), single-loaded corridors and an open floor plan to optimize daylight and natural ventilation.
- Thermal Massing.
  - Locate a material with high thermal mass on the southern portion of the house where sunlight hits during the heating season.
  - Materials with thermal mass include brick, concrete, stone, water and any other material of a similar high density and specific heat capacity.
  - The thermal mass location must be shown in the schematic wall section of the southern façades.
- Additional potential passive cooling strategies
  - Plant deciduous shade trees at the south façades.
  - Maximize cross ventilation by installing operable windows at the leeward and windward sides of the building.
  - Install reflective roofing or coat existing roofs with reflective elastomeric coatings

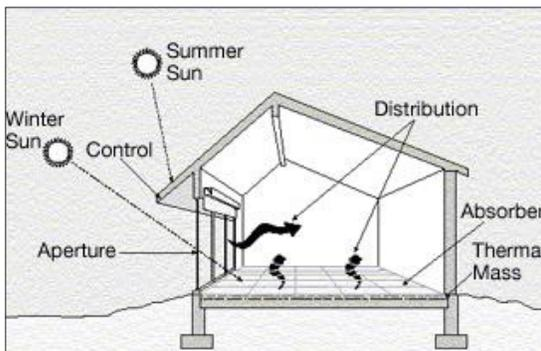

Five Elements of Passive Solar Design



Utilities Board Building Passive Solar Design

## RESOURCES

- U.S. Department of Energy, Building Technologies Office, Passive Solar Heating and Cooling: [energy.gov/energysaver/articles/tips-passive-solar-heating-and-cooling](https://www.energy.gov/energysaver/articles/tips-passive-solar-heating-and-cooling)
- U.S. Department of Energy, Building Technologies Office, Passive Solar Design Fact Sheet: A part of the department's "Building Toolbox," this site includes tips and techniques for passive solar heating, passive solar cooling, thermal storage and daylighting: [www.nrel.gov/docs/fy01osti/29236.pdf](https://www.nrel.gov/docs/fy01osti/29236.pdf)
- U.S. Department of Energy, "Passive Solar Design": [apps1.eere.energy.gov/buildings/publications/pdfs/building\\_america/29236.pdf](https://apps1.eere.energy.gov/buildings/publications/pdfs/building_america/29236.pdf)
- U.S. Department of Energy, "Passive Solar Design for the Home": [www.nrel.gov/docs/fy01osti/27954.pdf](https://www.nrel.gov/docs/fy01osti/27954.pdf)
- U.S. Department of Energy- Whole-House Systems Approach: [energy.gov/public-services/homes/home-design-remodeling](https://www.energy.gov/public-services/homes/home-design-remodeling)
- U.S. Department of Energy, Office of Energy Efficiency & Renewable Energy: Zero Energy Ready Home National Program. [www.energy.gov/eere/buildings/zero-energy-ready-home](https://www.energy.gov/eere/buildings/zero-energy-ready-home)

## 2.11 GRAYFIELD OR BROWNFIELD SITE OR ADAPTIVE REUSE BUILDING

### OPTIONAL / 10 POINTS

#### REQUIREMENTS

To receive credit for adaptive reuse building, rehabilitate an existing structure for a use not previously used for.

To receive credit for brownfield site development, locate the project on a site for which part or all is documented as contaminated by means of an ASTM E1903-97 Phase II Environmental Site Assessment or a local Voluntary Cleanup Program, or on a site defined as a brownfield by a local, state or federal government agency. Remediate site contamination such that the controlling public authority approves the protective measures and/or cleanup as effective, safe and appropriate for the future use of the site.

To receive credit for Grayfield site development, locate the project on a site the local government has deemed a Grayfield site defined as an abandoned public building or an industrial or commercial property that meets all the following requirements:

1. Infrastructure on the property is outdated or prevents an efficient use of the property, including vacant, blighted, obsolete, or otherwise underutilized property.
2. Property improvements and infrastructure are at least 25 years old and one or more of the following conditions exist:
  - Thirty percent or more of a building located on the property is available for occupancy and has been vacated or unoccupied for at least 12 months;
  - Assessed value of improvements on the property has decreased by 25 percent or more;
  - The property is used as a parking lot;
  - Improvements on the property no longer exist.

#### RATIONALE

Use of brownfields reduces pressure on undeveloped land. Reuse of existing structures reduces the need for new materials.

#### RESOURCES

- Iowa Brownfield/Grayfield Tax Credit Program promotes the economic health of communities by reducing environmental potential hazards, cleaning up eyesores, creating new jobs and boosting tax revenue: [www.iowaeconomicdevelopment.com/Regulatory/brownfield](http://www.iowaeconomicdevelopment.com/Regulatory/brownfield)
- Iowa Brownfield Redevelopment Program provides technical assistance and potentially financial assistance for select projects: [www.iowadnr.gov/Environmental-Protection/Land-Quality/Contaminated-Sites/Brownfields](http://www.iowadnr.gov/Environmental-Protection/Land-Quality/Contaminated-Sites/Brownfields)
- U.S. Environmental Protection Agency, Brownfields Cleanup and Redevelopment Program provides grants and technical assistance to communities, states, tribes and others to assess, safely clean up and sustainably reuse contaminated properties: [www.epa.gov/brownfields](http://www.epa.gov/brownfields)
- Center for Community Progress provides assistance to communities to help turn vacant spaces into vibrant places: [www.communityprogress.net](http://www.communityprogress.net)
- State of Place's predictive software can assist communities in making wise investments to create walkable, livable and smarter places: [www.stateofplace.co](http://www.stateofplace.co)

## 2.12 ACCESS TO FRESH, LOCAL FOODS

### OPTIONAL | 6 POINTS

#### REQUIREMENTS

##### **Option 1: Neighborhood Farms and Gardens [6 points]**

- a) Dedicate permanent and viable growing space and/or related facilities (such as greenhouses) within the project equal or greater in size to 10 square feet per dwelling unit of the project. Provide solar access, fencing, watering systems, garden bed enhancements (such as raised beds), secure storage space for tools and pedestrian access for these spaces. Ensure that the spaces are owned and managed by an entity that includes occupants of the project in its decision-making, such as a community group, homeowners' association or public body.

Established community gardens outside the project boundary but within a 0.5-mile walk distance of the project's geographic center can satisfy this option if the garden otherwise meets all of the option requirements. Ensure that the gardens are built and maintained in a manner to minimize pests and in keeping with Integrated Pest Management practices.

OR

- b) Dedicate permanent and viable growing space and/or related facilities (such as greenhouses) within the project equal or greater in size to 10 square feet per dwelling unit of the project, and establish an agreement with a local farming operation to farm the land. Ensure in the agreement that at least 50% of the produce is made available for purchase by the project's tenants. Provide solar access, fencing, watering systems, garden bed enhancements (such as raised beds) and secure storage space for tools.

OR

##### **Option 2: Community-Supported Agriculture [6 points]**

Offer a specified location within the project boundaries for delivery of community-supported agriculture (CSA) program shares for residents, project staff and surrounding community members, as appropriate. The working lands supplying the CSA shares must be within 400 miles of the project site, or be within the same state. Shares must be delivered to the specified delivery point on a regular schedule at least twice a month for at least four months of the year.

OR

##### **Option 3: Proximity to Farmers Market [6 points]**

Locate the project's geographic center within a 0.5-mile walk distance of an existing or planned farmers market that is open or will operate at least once a week for at least five months of the year. Farmers market vendors may sell only items grown within 400 miles of the project site, or from within the same state. A planned farmers market must have firm commitments from farmers and vendors that the market will meet all of the above requirements and be in full operation by the time there is 50% occupancy of the project's dwelling units.

---

## RATIONALE

Access to fresh produce offers healthy food options for residents, and purchase of fresh produce directly from farmers demystifies the cycle of food production. This measure also supports local economic development that increases the economic value and production of farmlands and community gardens. An ability to obtain local food offers important resilience benefits should major U.S. agricultural areas in the Midwest and California be threatened, for instance.

## RECOMMENDATIONS

- For projects pursuing Option 1a, consider bringing in an individual or a group (e.g., a master gardener or a garden club) to work with the residents to establish the garden and maintain productivity.
- Encourage fresh food providers, including those who organize farmers markets and run food cooperatives (co-ops), to accept Electronic Benefit Transfer (EBT) and Supplemental Nutrition Assistance Program (SNAP).
- Incorporating cooking classes for residents into your resident engagement program (see Category 8: Operations, Maintenance + Occupant Engagement) is an excellent way to incentivize residents to eat healthy and prepare meals with fresh foods.

## RESOURCES

- Local Harvest: This website offers a search function to find farmers markets, family farms and other sources of local, sustainably grown food in a given area: [www.localharvest.org](http://www.localharvest.org)
- U.S. Department of Agriculture, National Agricultural Library, Food and Nutrition Information Center, Community Food Systems: This website links to dozens of publications, programs and other sites: [fnic.nal.usda.gov](http://fnic.nal.usda.gov)
- Enterprise Community Partners, “Fresh, Local Food Access Toolkit”: This toolkit, which is designed to provide step-by-step instructions and resources to implement a fresh food access model that meets the Enterprise Green Communities Access to Fresh, Local Food Criteria, best addresses the needs of your development, and leverages the assets of your organization and neighborhood: [www.enterprisecommunity.org/download?fid=2432&nid=14222](http://www.enterprisecommunity.org/download?fid=2432&nid=14222)

---

## 2.13 LEED FOR NEIGHBORHOOD DEVELOPMENT CERTIFICATION

### *OPTIONAL | 4 POINTS*

#### *REQUIREMENTS*

Locate building(s) in a LEED for Neighborhood Development project. Demonstrate that the project has earned either Stage 2 Pre-Certified or Stage 3 Certified Neighborhood Development status through LEED for Neighborhood Development at the time of construction completion of your building(s).

#### *RATIONALE*

Projects located in LEED for Neighborhood Development Certified Developments have taken steps to minimize the environmental impact of land development practices. LEED for Neighborhood Development is designed to certify exemplary development projects that perform well in terms of smart growth, urbanism and green building.

#### *RESOURCES*

- U.S. Green Building Council, LEED for Neighborhood Development: This page has links to the LEED-ND rating system, a project checklist and information on certification: [www.usgbc.org/leed#rating](http://www.usgbc.org/leed#rating)

INTRODUCTION CRITERIA  
CHECKLIST  
1 INTEGRATIVE DESIGN  
2 LOCATION +  
NEIGHBORHOOD FABRIC  
3 **SITE IMPROVEMENTS**  
4 WATER CONSERVATION  
5 ENERGY EFFICIENCY  
6 MATERIALS  
7 HEALTHY LIVING  
ENVIRONMENT  
8 OPERATIONS,  
MAINTENANCE  
+ OCCUPANT  
ENGAGEMENT  
APPENDIX

## SITE IMPROVEMENTS

LOW-IMPACT DESIGN AND  
DEVELOPMENT PRINCIPLES  
MINIMIZE THE SITE'S  
ENVIRONMENTAL FOOTPRINT  
AND LOWER INFRASTRUCTURE  
COSTS ASSOCIATED WITH  
STORMWATER MANAGEMENT.

## 3.1 ENVIRONMENTAL REMEDIATION

### MANDATORY

#### *REQUIREMENTS*

Determine whether there are any hazardous materials present on-site by conducting either 1) a Phase I Environmental Site Assessment, 2) a Tier II Environmental Review Assessment per HUD funding requirement, 3) an environmental site assessment approved by HUD through the Part 50 or Part 58 process, or 4) an environmental assessment approved by USDA through the 1940-G or 1794 process, and any additional required assessments.

If an environmental site assessment reveals any hazardous materials, mitigate these before proceeding with development.

#### *RATIONALE*

The environmental site assessment determines the potential environmental liabilities associated with property acquisition and ownership.

To help satisfy any site environmental concerns, and to establish liability protections, the first step is known as a Phase I Environmental Site Assessment (ESA). A Phase I ESA takes place prior to purchase and involves research into the site's development history, past uses, and environmental records in and around the site area, in order to determine the likelihood that the site could have been adversely impacted by environmental contaminants.

If you conduct such an “all appropriate inquiry” into the property's past uses and environmental conditions, this can help with establishing liability protections for you under Federal Law as an “innocent landowner” or a “bona fide prospective purchaser”.

To qualify for the Federal liability protections, a Phase I ESA must be conducted using ASTM Standard E1527-05. A Phase I that is conducted without following this Standard will not qualify for Federal liability protections. Phase Is are conducted by environmental consulting or engineering firms for a fee. You should ensure that any firm you hire is familiar with the ASTM Standard, and can confidently complete a Phase I review.

#### **Conducting a Follow-up Phase II Assessment**

When a Phase I indicates that past uses or site conditions may have created the likelihood of an environmental release, it may be beneficial to physically investigate soils and groundwater at the site to determine if contamination is actually present, and to what extent and concentration. An assessment to confirm if contamination is present is known as a Phase II Environmental Site Assessment.



## RESOURCES

- Iowa Economic Development Authority Brownfield Site Redevelopment Program: [iowaeconomicdevelopment.com/Regulatory/brownfield](http://iowaeconomicdevelopment.com/Regulatory/brownfield)
- Iowa DNR Land Recycling Program: [www.iowadnr.gov/InsideDNR/RegulatoryLand/ContaminatedSites/LandRecyclingProgramLRP.aspx](http://www.iowadnr.gov/InsideDNR/RegulatoryLand/ContaminatedSites/LandRecyclingProgramLRP.aspx)
- EPA Brownfields Program: [www.epa.gov/brownfields](http://www.epa.gov/brownfields)
- HUD, Environmental Review Procedures for Entities Assuming HUD Environmental Responsibilities (24 CFR Part 58 process): [hudexchange.info/resource/167/environmental-review-procedures-24-cfr-58](http://hudexchange.info/resource/167/environmental-review-procedures-24-cfr-58)
- HUD, Part 50 process: [hudexchange.info/resource/5173/part-50-environmental-assessment-format](http://hudexchange.info/resource/5173/part-50-environmental-assessment-format)
- USDA, Environmental Review Process, 1940-G: [www.rd.usda.gov/files/3565-1chapter11.pdf](http://www.rd.usda.gov/files/3565-1chapter11.pdf)

## 3.2 EROSION AND SEDIMENTATION CONTROL

### MANDATORY

#### REQUIREMENTS

All construction that disturbs one acre or more requires a stormwater general permit #2 from the Iowa Department of Natural Resources. Obtain authorization and follow the requirements of the permit including the development and implementation of a Stormwater Pollution Prevention Plan. Submit a copy of the stormwater general permit #2 and the Stormwater Pollution Prevention Plan before site disturbance begins.

For projects disturbing less than one acre, implement EPA's Best Management Practices for erosion and sedimentation control during construction, referring to the EPA document, Stormwater Management for Construction Activities (EPA 832-R-92-005).

All erosion control structures must be inspected and maintained.

#### RATIONALE

Erosion and sedimentation control during site development keeps valuable topsoil on-site and reduces pollution, limits stormwater runoff (especially during storm events), and limits sedimentation associated with construction activities from contaminating local waterways. Soils compacted from construction activities are less able to absorb water, resist plant root penetration and lack the porosity needed for adequate aeration.

#### RECOMMENDATIONS

Erosion control measures must include all of the following:

- Stockpile and protect disturbed topsoil from erosion (for reuse).
- Control the path and velocity of runoff with silt fencing or comparable measures.
- Protect on-site storm sewer inlets, streams, and lakes with straw bales, silt fencing, silt sacks, rock filters, or comparable measures.
- Provide swales to divert surface water from hillsides.
- If soils in a sloped area (i.e., 25%, or 4:1 slope) are disturbed during construction, use tiers, erosion blankets, compost blankets, filter socks and berms, or some comparable approach to keep soil stabilized.
- No compaction inside the drip ring of existing trees and shrubs.

## RESOURCES

- Iowa Construction Site Erosion Control Manual  
[www.iowadnr.gov/portals/idnr/uploads/water/stormwater/constructionmanual.pdf](http://www.iowadnr.gov/portals/idnr/uploads/water/stormwater/constructionmanual.pdf)
- Iowa Department of Natural Resources General Permit #2 information  
[www.iowadnr.gov/Environmental-Protection/Water-Quality/NPDES-Wastewater-Permitting/NPDES-General-Permits](http://www.iowadnr.gov/Environmental-Protection/Water-Quality/NPDES-Wastewater-Permitting/NPDES-General-Permits)
- Iowa Statewide Urban Design and Specifications (SUDAS) [www.iowasudas.org](http://www.iowasudas.org)
- Iowa Stormwater Education Partnership [www.iowastormwater.org](http://www.iowastormwater.org)
- EPA Erosion and Sediment Control Model Ordinances [water.epa.gov/polwaste/nps/mol2.cfm](http://water.epa.gov/polwaste/nps/mol2.cfm)
- U.S. Environmental Protection Agency, “Construction Site Stormwater Runoff Control.”  
[water.epa.gov/polwaste/npdes/swbmp](http://water.epa.gov/polwaste/npdes/swbmp)
- EnviroCert International, Inc.: Use the Certificant Search on this website to find erosion and sedimentation control professionals in your state. [www.cpesec.net](http://www.cpesec.net)

## 3.3 LOW-IMPACT DEVELOPMENT

### MANDATORY FOR PROJECTS LOCATED ON GREENFIELDS

#### MANDATORY

#### REQUIREMENTS

Projects located on greenfields must meet the following low-impact development criteria:

- Retain, infiltrate and /or harvest the first 1.25 inches of rain that falls on the entire site in a 24-hour period. (See Criterion 3.5 Surface Stormwater Management).
- Design roadways to be along topographic contours and ridgelines so as to avoid erosion and unnecessary cut and fill.
- Design roadway plans to utilize the minimum necessary pavement required by code, such as narrower roads, minimized parking and thoughtful road layout. Consult with local fire department(s) regarding roadway sizing as needed.
- Design roadway sections with localized retention such as swales, retention basins, plantings and permeable paving to convey, capture, infiltrate and /or reuse stormwater. This can be accomplished in a manner that also complies with Criterion 3.5 Surface Stormwater Management.
- Do not implement a curb and gutter system. Projects located in municipalities that require curb and gutter infrastructure for all developments are exempt from this sub-requirement.

#### RATIONALE

Low-impact design and development principles minimize the site’s environmental footprint while helping to control and mitigate stormwater runoff during significant storm events.

## RECOMMENDATIONS

- Keep existing trees and vegetation to the extent feasible.
- Best practices include a grade of one-half inch per foot, or approximately a 4% pitch. EPA recommends a 2% pitch (one-quarter inch per foot) for hard surfaces such as patio slabs, walks and driveways.

## RESOURCES

- U.S. Environmental Protection Agency, Low-Impact Development: An Integrated Design Approach. [water.epa.gov/polwaste/green/upload/lidnatl.pdf](https://www.water.epa.gov/polwaste/green/upload/lidnatl.pdf)
- U.S. Environmental Protection Agency, Low-Impact Development. [water.epa.gov/polwaste/green](https://www.water.epa.gov/polwaste/green)

## 3.4 LANDSCAPING

### MANDATORY

#### REQUIREMENTS

Develop a landscape plan, including specifications, for soil preparation, planting, and a landscape maintenance plan for during and after establishment period. Commit to at least 50% native tree and plant species, 100% appropriate to the site's soils and microclimate, and do not include invasive species. Invasive species are plants that are introduced to an area outside their original range, threaten Iowa's biodiversity and cause harm in their new home.



Limit application of



non-native turf species.



[Native Plant Database](#) [Sustainable Site Design](#) [Xeriscaping](#)

### RATIONALE

Native vegetation is well suited to the climate and provides excellent erosion, sediment, dust and pollution control, and, when carefully sited, plantings can help to control unwanted solar gain. Native plants are more resistant to naturally occurring disease, insects, drought, low levels of nutrients and major storm events, while reducing or eliminating the need for fertilizers, pesticides, herbicides and irrigation.

## RECOMMENDATIONS

- Consult a landscape architect or your local arborist in the integrative design process to identify appropriate areas for landscaping and shading.
- Consider “naturescaping,” a landscaping strategy that conserves water and reduces runoff while providing habitat for beneficial insects, birds and other wildlife. In areas where water shortages are common, consider “xeriscaping,” a landscaping strategy that uses drought-resistant plants to significantly reduce or eliminate the need for irrigation.
- Integrate the landscape plans with the stormwater management plan to provide water and drainage that is complementary with plantings.
- Provide visually appealing environments along paths of travel with visually interesting landscaping (e.g., a variety of colors, textures and flowering times).
- Ensure that the expected heights of plants adjacent to pedestrian walkways or seating areas are appropriate to maintain visibility into and out of the corridor in order to facilitate a safe and secure environment.

## RESOURCES

- Iowa Stormwater Management Manual Infiltration Practices [www.iowadnr.gov/Environmental-Protection/Water-Quality/NPDES-Storm-Water/Storm-Water-Manual](http://www.iowadnr.gov/Environmental-Protection/Water-Quality/NPDES-Storm-Water/Storm-Water-Manual)
- Iowa Living Roadway Trust Fund Native Plant Database [www.iowalivingroadway.com/NativePlants.aspx](http://www.iowalivingroadway.com/NativePlants.aspx)
- Iowa Prairie Network [www.iowaprairienetwork.org](http://www.iowaprairienetwork.org)

## 3.5 SURFACE STORMWATER MANAGEMENT

**(REHAB PROJECTS MAY GET A WAIVER IF SITE CONSTRAINTS – CONSULT WITH IEDA BEFORE SUBMITTING PROPOSAL)**

### MANDATORY

#### REQUIREMENTS

Utilize green infrastructure practices to infiltrate, evapotranspire, capture and reuse the water quality volume (runoff from up to 1.25” of rain per 24 hours) to maintain or restore natural hydrologies. Green infrastructure practices utilized shall follow the design specifications, if available, in the Iowa Stormwater Management Manual. Provide owner a green infrastructure maintenance plan.

**Project design teams shall consult with Iowa Department of Agriculture and Land Stewardship (IDALS) [Urban Conservation Program Team](#) on project stormwater management designs at beginning of design, 30%, 60%, 90%, and final design.** Prior to going to project bid, the Recipient will secure and upload to [www.iowagrants.gov](http://www.iowagrants.gov) the Milestones Checklist (Appendix J) signed by an IDALS team member confirming stormwater management designs meet the requirements of the [Iowa Stormwater Management Manual](#).

Have the project or site designer take and email pictures to [greenstreets@iowaeda.com](mailto:greenstreets@iowaeda.com) of installation and completion of stormwater management practices. Medians, where needed, should be seen as opportunities for installing infiltration-based green infrastructure practices. The use of raised medians is discouraged and should be avoided.



Pervious Pavements



Biocells/Rain Gardens



Rain Water Harvesting



Green Roofs



Native Vegetation



Soil Quality Restoration

## RATIONALE

Reducing or eliminating stormwater runoff through design and management techniques increases on-site filtration, reduces total suspended solids (TSS) and other pollutants from entering waterways, and reduces soil erosion. From a resiliency standpoint, minimizing stormwater runoff and storm sewer flows also helps reduce downstream flooding — an important concern with more intense storms predicted in the future. Water storage and nutrient collection processes reduce the need for irrigation and contribute to forming a healthier ecological community within the landscape.

## RECOMMENDATIONS

- Seek out contractors that are certified rainscapers through Rainscaping Iowa training
- Minimize and disconnect impervious areas (surfaces that do not allow stormwater infiltration), including roofs, driveways, sidewalks and streets, or use porous materials for such areas
- If a rainwater harvesting and storage strategy is considered in addition to infiltration, check with state and local governments to verify that capture and/or reuse of rainwater is permitted. If not, consider appealing local rules.
- Attempt to make use of innovative, low-impact techniques such as disconnected downspouts, permeable paving, swales, retention basins, rain gardens, green roof, rain barrels and cisterns to convey, capture, infiltrate and /or reuse stormwater.
- Minimize impervious areas (surfaces that do not allow stormwater infiltration), including roofs, driveways, sidewalks and streets, or use porous materials for such areas. Water-permeable materials include pervious interlocking concrete paving blocks, concrete grid pavers, perforated brick pavers and compacted gravel.
- To provide a visual reminder that storm sewer inlets connect to area waterways and groundwater storages, use a plaque, tile, painted or pre-cast message such as “No Dumping. Drains to [name of water source].” If project is unable to label storm inlets due to jurisdictional constraints, the project team must provide documentation.
- Best practices include a grade of one-half inch per foot, or approximately a 4% pitch. EPA recommends a 2% pitch (one-quarter inch per foot) for hard surfaces such as patio slabs, walks and driveways.

## RESOURCES

- Iowa Stormwater Management Manual [www.iowadnr.gov/Environmental-Protection/Water-Quality/NPDES-Storm-Water/Storm-Water-Manual](http://www.iowadnr.gov/Environmental-Protection/Water-Quality/NPDES-Storm-Water/Storm-Water-Manual)
- Iowa Urban Conservation Program [www.iowaagriculture.gov/FieldServices/urbanConservation.asp](http://www.iowaagriculture.gov/FieldServices/urbanConservation.asp)
- Rainscaping Iowa [www.rainscapingiowa.org](http://www.rainscapingiowa.org)
- Iowa Storm Water Education Partnership [www.iowastormwater.org](http://www.iowastormwater.org)
- The Sustainable Sites Initiative (SITES) [www.asla.org/sites](http://www.asla.org/sites)
- Institute for Sustainable Infrastructure: Envision Rating System [sustainableinfrastructure.org/envision](http://sustainableinfrastructure.org/envision)
- Center for Watershed Protection [www.cwp.org](http://www.cwp.org)
- EPA Green Infrastructure [water.epa.gov/infrastructure/greeninfrastructure/index.cfm](http://water.epa.gov/infrastructure/greeninfrastructure/index.cfm)
- International Stormwater BMP Database [www.bmpdatabase.org](http://www.bmpdatabase.org)
- Low Impact Development Center [www.lowimpactdevelopment.org](http://www.lowimpactdevelopment.org)

## 3.6 REDUCING HEAT-ISLAND EFFECT: PAVING

### OPTIONAL | 1 POINT

### REQUIREMENTS

Use light-colored, high-albedo materials and/or an open-grid pavement, with a minimum solar reflectance of 0.3, over at least 50% of the site's hardscaped area. Locate and plant appropriate overstory trees to provide shade for both heat island reduction and user comfort; one shade tree per 10 parking spaces minimum.

### RATIONALE

Urban heat islands increase local air temperatures due to the absorption of solar energy by the built environment. Reducing the heat-island effect decreases energy consumption by decreasing loads on cooling systems.

### RECOMMENDATIONS

Consider using paving materials that both reduce urban heat-island effect and that are water permeable.

### RESOURCES

- U.S. Environmental Protection Agency, Heat Island Effect: This site contains information about heat-island effect, its social and environmental costs, and strategies to minimize its prevalence, including shading and coloration of hardscapes. [www.epa.gov/heatisland](http://www.epa.gov/heatisland)
- Lawrence Berkeley National Laboratory, Heat Island Group: The Lawrence Berkeley National Laboratory conducts research to find, analyze and implement solutions to minimizing heat-island effects. Its current efforts focus on the study and development of more reflective surfaces for roadways and buildings. [heatisland.lbl.gov](http://heatisland.lbl.gov)

INTRODUCTION CRITERIA  
CHECKLIST  
1 INTEGRATIVE DESIGN  
2 LOCATION +  
NEIGHBORHOOD FABRIC  
3 SITE IMPROVEMENTS  
4 WATER CONSERVATION  
5 ENERGY EFFICIENCY  
6 MATERIALS  
7 HEALTHY LIVING  
ENVIRONMENT  
8 OPERATIONS,  
MAINTENANCE  
+ OCCUPANT  
ENGAGEMENT  
APPENDIX

## WATER CONSERVATION

WATER CONSERVATION  
TRANSLATES INTO DIRECT  
UTILITY SAVINGS FOR  
RESIDENTS AND BUILDING  
OWNERS AND CONSERVES  
A PRECIOUS NATIONAL  
RESOURCE.

## 4.1 WATER-CONSERVING FIXTURES

### MANDATORY

#### REQUIREMENTS

##### Non-Residential

Install water-conserving fixtures in all units and any common facilities with the following specifications:

- Toilets: WaterSense-labeled and 1.28 gpf (gallons per flush) or less, OR dual-flush toilets, OR pressure-assisted toilets 1.6 gpf maximum
- Urinals: WaterSense-labeled and 0.128 gpf maximum
- Showerheads: WaterSense-labeled and 1.75 gpm (gallons per minute) or less
- Kitchen faucets: 2.0 gpm or less (WaterSense label not available)
- Lav faucets: WaterSense-labeled and 0.5 gpm or less at 60 psi

##### Residential

Install water-conserving fixtures in all units and any common facilities with the following specifications:

- Toilets: WaterSense-labeled and 1.28 gpf (gallons per flush) or less, **OR** dual-flush toilets, OR pressure-assisted toilets
- Urinals: WaterSense-labeled and 0.128 gpf maximum
- Showerheads: WaterSense-labeled and 1.75 gpm (gallons per minute) or less
- Kitchen faucets: 2.0 gpm or less (WaterSense label not available)
- Lav faucets: WaterSense-labeled and 1.5 gpm or less

#### AND

For all single-family homes and all dwelling units in buildings three stories or fewer:

The static service pressure must not exceed 60 pounds per square inch (psi) (414 kilopascal [kPa]). For units in multifamily buildings, the service pressure within each unit must not exceed 60 psi.

Compliance for homes supplied by groundwater wells shall be achieved by use of a pressure tank.

Compliance for single-family homes with publicly supplied water may be achieved by one of the following methods:

- Use of a pressure-regulating valve (PRV) downstream of the point of connection. All fixture connections shall be downstream of the PRV.
- Determination that the service pressure at the home is 60 psi or less at the time of inspection and documentation from the public water supplier that service pressure is unlikely to regularly exceed 60 psi at the home on a daily or seasonal basis.

Piping for fire sprinkler systems is excluded from this requirement and should comply with state and local codes and regulations.

#### RATIONALE

Water conservation translates into direct utility savings for building tenants and building owners, and lowers infrastructure costs associated with stormwater management and water treatment facilities. Reduced water pressure saves water, conserves energy and helps ensure proper operation of fixtures and appliances.

## RECOMMENDATIONS

- Certain existing fixtures, such as bathroom faucets, can be retrofitted with aerators rather than be replaced to reduce water flow to the requisite level. Note that WaterSense-labeled aerators are available and recommended.

## RESOURCES

- EPA's WaterSense® [www.epa.gov/watersense](http://www.epa.gov/watersense)



WaterSense Fixtures



Rain Water Harvesting

## 4.2 ADVANCED WATER CONSERVATION

### OPTIONAL | 6 POINTS MAXIMUM

#### REQUIREMENTS

Reduce water consumption by one of the two following methods:

##### Option 1 [3 points maximum]

Install water-conserving fixtures in all units and all common space bathrooms with the following specifications:

- Toilets: WaterSense-labeled and 1.1 gpf (gallons per flush) or less [1 point]
- Showerheads: WaterSense-labeled and 1.5 gpm (gallons per minute) or less [1 point]
- Kitchen faucets: 1.5 gpm or less AND Lav faucets: WaterSense-labeled and 0.5 gpm or less [1 point]

OR

##### Option 2 [6 points maximum]

Reduce total indoor water consumption by at least 30% compared to the baseline indoor water consumption chart below through a combination of fixtures of your choosing.

Calculate and compare your project per-person per-day indoor water consumption to the baseline water consumption chart below [adapted from: LEED for Homes v4, Table 1: Indoor Water Baseline Consumption (per person per day)]. When making your comparison, assume that the baseline project has the same type of fixtures as your project in question. For instance, if your project does not include dishwashers, do not include dishwasher water consumption in your baseline project calculation for comparison.

PERCENTAGE OF REDUCTION IN TOTAL INDOOR WATER CONSUMPTION	NUMBER OF OPTIONAL POINTS
30%	4 points
50%	5 points
70%	6 points

#### BASELINE INDOOR WATER CONSUMPTION (PER PERSON PER DAY)

FIXTURE	BASELINE FLUSH OR FLOW RATE	ESTIMATED FIXTURE USAGE	ESTIMATED WATER USAGE
Shower (per compartment)	2.5 gpm	6.15 minutes	15.4 gallons
Lav, Kitchen faucet	2.2 gpm	5.0 minutes	11 gallons
Toilet	1.6 gpf	5.05 flushes	8 gallons
Clothes washer	8.4 WF* top loading and 4.7 WF front loading	0.37 cycles @ 3.5 ft <sup>3</sup>	13.2 gallons top loading 7.4 gallons front loading
Dishwasher	5.0 gpc standard and 3.5 gpc small	0.1 cycles	0.5 gallons standard and 0.4 gallons small

\*WF = Water Factor

### RATIONALE

Water conservation translates into direct utility savings for residents and building owners, and lowers infrastructure costs associated with stormwater management and water treatment facilities.

### RECOMMENDATIONS

- See Recommendations for Criterion 4.1: Water-Conserving Fixtures.
- Water consumption calculation for example project with 1.5 gpm showerheads, 1.0 gpm lav faucets, 1.5 gpm kitchen faucets, 1.1 gpf toilets, 8.4 WF clothes washers and no dishwashers:

$$(1.5 \text{ gpm})(6.15 \text{ min.}) + (1.0 \text{ gpm})(5.0 \text{ min}) 2 + (1.5 \text{ gpm})(5.0 \text{ min}) + (1.1 \text{ gpf})(5.05 \text{ flushes}) + 13.2 \text{ gal} = 40.475 \text{ gal}$$

compared to a baseline. Calculate a baseline by referring to the proper type of fixtures in the Baseline Indoor Water Consumption chart.

$$15.4 \text{ gal} + 11 \text{ gal} + 11 \text{ gal} + 8 \text{ gal} + 13.2 \text{ gal} = 58.6 \text{ gal}$$

The proposed project has reduced indoor water consumption per person by 31% compared to the baseline.

### RESOURCES

See Resources for Criterion 4.1: Water-Conserving Fixtures.

## 4.3 LEAKS AND WATER METERING

### OPTIONAL | 4 POINTS

#### REQUIREMENTS

Conduct pressure-loss tests and visual inspections to determine if there are any leaks; fix any leaks found. Visual inspections should include checking for leaks at all accessible, visible water supply connections and valves for water-using fixtures, appliances and equipment.

#### RATIONALE

In some cases, leaks may be the largest driver of project water consumption. Properly installed water-using fixtures, equipment and appliances should not leak.

Individual metering or submetering of each unit allows building managers and residents to understand and better manage their water use. Monitoring individual units also enables property managers to more easily identify and manage potential issues such as leaks that might be occurring within a specific unit.

#### RECOMMENDATIONS

- As a first step, when designing the plumbing system for a multifamily building, consider supplying each unit with a single pipe source for the water to facilitate individual unit submetering. This will reduce costs associated with having to install multiple meters for several points of use attached to a single riser pipe.
- Second, choose equipment that is best suited for accurately measuring water use in each unit. Because water use within individual units will fluctuate between low and peak flows, depending on the unit's occupancy and the time of day, positive displacement meters are often the best option. Also, work with the meter manufacturer to select an appropriately sized submeter. It is critical to understand both the building's and the individual units' size, function, fixture types, usage occupancy and peak population in order to select an appropriately sized meter. These statistics determine the minimum and maximum flow rates and will assist in the selection of a properly sized water meter for each unit.
- Follow manufacturers' instructions closely so that proper installation can occur. Improper installation can lead to metering inaccuracies. In general, meters (including submeters for individual units) should be installed in an accessible location to allow for reading and repair. In addition, the meter location should be protected from potential damage. To ensure uniform flow entering and exiting the meter, the meter should be located where there is sufficient length of straight pipe above and below the meter. Also, install a strainer to prevent debris and sediment from entering the meter and causing reading inaccuracies.
- Several options exist for monitoring water use on a per-unit basis. Meters are typically owned by the water purveyor and represent separate accounts. In order to be separately metered, each unit must typically represent a wholly separate plumbing system attached to the main line. Submetering typically involves using smaller meters to monitor the different uses of water under a single account. Several alternative technologies are emerging that give property managers the ability to track water use on a per-unit basis without installing physical meters or submeters for each unit.

## RESOURCES

- National multifamily housing study that showed submetering reduced water use by 15.3%: [www.allianceforwaterefficiency.org/WorkArea/DownloadAsset.aspx?id=704](http://www.allianceforwaterefficiency.org/WorkArea/DownloadAsset.aspx?id=704)
- American Water Works Association Offers information and articles on submetering: [www.awwa.org](http://www.awwa.org)
- WaterSense-labeled New Homes: [www.epa.gov/watersense/new\\_homes](http://www.epa.gov/watersense/new_homes)
- Alliance for Water Efficiency, “Submetering Introduction.” [www.allianceforwaterefficiency.org/submetering.aspx](http://www.allianceforwaterefficiency.org/submetering.aspx)

## 4.4 EFFICIENT PLUMBING LAYOUT AND DESIGN

### OPTIONAL | 4 POINTS

#### REQUIREMENTS

To minimize water loss from delivering hot water, the hot water delivery system shall store no more than 0.5 gallons of water in any piping/manifold between the hot water source and any hot water fixture. To account for the additional water that must be removed from the system before hot water can be delivered, no more than 0.6 gallons of water shall be collected from the hot water fixture before hot water is delivered. Recirculation systems must be demand-initiated. Systems that are activated based solely on a time and/or temperature sensor do not meet this requirement.

#### RATIONALE

Efficiently designed hot water delivery systems reduce the amount of time it takes hot water to reach a fixture, saving both water and energy. Approximately 10–15% of the energy use associated with the hot water delivery system is wasted in distribution losses, and studies have shown that the average home wastes more than 3,650 gallons of water per year waiting for hot water to arrive at the point of use.

#### RECOMMENDATIONS

- Effective and efficient distribution of hot water requires a whole-system approach and can be challenging to many builders. Considering the hot water delivery system early in the design phase and carefully following a plumbing design can deliver superior homes and reduced installation costs.
- A hot water distribution system with less stored water in its piping will waste less water and energy. The length of piping between the water heater and each fixture, the pipe diameter and piping material can have a great cumulative impact on the efficiency of hot water delivery.
- Insulation of hot water pipes can improve the efficiency of a hot water distribution system. Insulation of hot water pipes reduces the rate of heat loss and can deliver water that is 2°F to 4°F hotter than uninsulated pipes can. Pipe sleeves made with polyethylene or neoprene foam with thicknesses of either ½ or ¾ inch are the most commonly used insulation. The pipe sleeve inside diameter should match the diameter of the pipe for a close fit. Securing insulation every one or two feet using tape, wire or cable tie will also help to fit insulation close to the pipe. Insulation should be used along the entire length of hot water pipes, including elbows and joints, but should be kept 6 inches away from the flue of gas water heaters. Insulation performs better with an R-value of R-3.0 or greater.
- Consider central core plumbing, and/or multiple stacked central core plumbing layout, locating the water heater very close to hot water fixtures.

## RESOURCES

- EPA Hot Water Volume Tool: This editable tool allows project teams to design their plumbing system with a variety of materials to minimize waste in delivery:  
[www.epa.gov/sites/production/files/2017-02/ws-homes-hot-water-volume-tool.xlsm](http://www.epa.gov/sites/production/files/2017-02/ws-homes-hot-water-volume-tool.xlsm)
- EPA WaterSense-labeled New Homes — Hot Water Delivery Systems:  
[www.epa.gov/watersense/watersense-labeled-homes-hot-water](http://www.epa.gov/watersense/watersense-labeled-homes-hot-water)
- EPA's Guide for Efficient Hot Water Delivery Systems:  
[www.epa.gov/watersense/guide-efficient-hot-water-delivery-systems](http://www.epa.gov/watersense/guide-efficient-hot-water-delivery-systems)
- “Hot-Water Distribution Systems Part 1,” Plumbing Systems & Design, Gary Klein, Mar/Apr 2004:  
[buildingincalifornia.com/wp-content/uploads/2014/03/Hot-Water-Distribution-Systems\\_Klein.pdf](http://buildingincalifornia.com/wp-content/uploads/2014/03/Hot-Water-Distribution-Systems_Klein.pdf)

## 4.5 WATER REUSE

### OPTIONAL | 6 POINTS MAXIMUM

#### REQUIREMENTS

Harvest, treat and reuse rainwater and/or greywater to meet a portion of the project's water needs. To achieve optional points, provide the defined percentage of the project's total water needs through rainwater and /or greywater (using either one or a combination of both strategies). Total water needs include all exterior and interior water use.

TOTAL WATER NEEDS SUPPLIED BY RAINWATER AND/OR GREYWATER	NUMBER OF OPTIONAL POINTS
10%	3 points
20%	4 points
30%	5 points
40%	6 points

#### RATIONALE

Rainwater and greywater reuse strategies reduce the need for municipal water supplies and sewage treatment. This is also an important resilience strategy, as it offers some level of protection against drought or interruptions in water supply.

#### RECOMMENDATIONS

- Rainwater and greywater systems are subject to state and local regulations and special requirements. In some jurisdictions, rainwater or greywater systems may not be allowed. Check with your local building code officials for requirements.
- Greywater may be stored and treated for non-potable uses such as toilet flushing and irrigation.

## RESOURCES

- The American Water Works Association maintains a Water Reuse Resource Community. [www.awwa.org/resources-tools/water-knowledge/reuse.aspx](http://www.awwa.org/resources-tools/water-knowledge/reuse.aspx)
- American Rainwater Catchment Systems Association maintains a virtual hub of rainwater harvesting resources: [www.arcsa.org](http://www.arcsa.org)
- International Living Building Institute, Achieving Water Independence in Buildings: This downloadable publication explains water reuse systems and regulatory barriers, and provides information for those wishing to explore the possibilities of water reuse in buildings and to reform limiting regulation. [living-future.org/wp-content/uploads/2016/11/Achieving\\_Water\\_Independence\\_in\\_Buildings.pdf](http://living-future.org/wp-content/uploads/2016/11/Achieving_Water_Independence_in_Buildings.pdf)



Rain Water Harvesting



Water Reuse AWWA



Living Building Challenge

## 4.6 NO IRRIGATION AND WATER REUSE IF IRRIGATION IS UTILIZED

### MANDATORY

### REQUIREMENTS

Do not install irrigation. Watering tubes for trees are allowed for an establishment period of two years. Irrigation systems already in existence onsite are grandfathered in.

### RATIONALE

On average, outdoor water use accounts for about 40 percent of residential water use. Native landscapes or carefully selected plantings can tolerate no irrigation once established, even in dry periods.

### RECOMMENDATIONS

- For grandfathered in irrigation systems, a minimum of 50 percent of the site's irrigation should reuse water from one of the following resources:
  - treated greywater
  - rainwater, collected from the roof or site
  - water from a municipal recycled water system
- Install a landscape of native, drought tolerant plantings.
- Utilize xeriscaping practices.

---

## RESOURCES

- See the American Society of Landscape Architects Sustainable SITES Initiative, a set of comprehensive, voluntary guidelines together with a rating system that assesses the sustainable design, construction, and maintenance of landscapes: [www.asla.org/sites](http://www.asla.org/sites)
- Plant Iowa Native maintains links to Iowa native plant resources: [www.plantiowanative.com/resources/#information](http://www.plantiowanative.com/resources/#information)
- EPA's WaterSense program maintains a Water-Smart Landscape Design webpage: [www.epa.gov/watersense/water-smart-landscape-design](http://www.epa.gov/watersense/water-smart-landscape-design)

## ENERGY EFFICIENCY

IMPROVEMENTS IN BUILDING ENERGY PERFORMANCE RESULT IN UTILITY COST SAVINGS FROM MORE EFFICIENT HEATING, COOLING, HOT WATER, LIGHTS AND APPLIANCES, WHICH IMPROVES RESIDENTS' COMFORT, LOWERS OPERATING COSTS, AND PROVIDES ENVIRONMENTAL BENEFIT.

- INTRODUCTION CRITERIA CHECKLIST
- 1 INTEGRATIVE DESIGN
- 2 LOCATION + NEIGHBORHOOD FABRIC
- 3 SITE IMPROVEMENTS
- 4 WATER CONSERVATION
- 5 ENERGY EFFICIENCY
- 6 MATERIALS
- 7 HEALTHY LIVING ENVIRONMENT
- 8 OPERATIONS, MAINTENANCE + OCCUPANT ENGAGEMENT
- APPENDIX

## 5.1 BUILDING PERFORMANCE REQUIREMENTS

*Criteria for all project types covered by Criterion 5.1a – 5.1e, unless otherwise noted within specific criterion.*

### MANDATORY

### REQUIREMENTS

All project types shall follow the building performance requirements below:

- Air Barrier and Insulation Inspection Component Guide;
- Energy Performance Table;
- Sampling Protocol; and
- High Performance Construction Best Practices (see Appendix G – Air Sealing Key Points)

#### AIR BARRIER AND INSULATION INSPECTION COMPONENT GUIDE

COMPONENT	CRITERIA
Air barrier and thermal barrier	<p><b>Exterior</b> thermal envelope insulation for framed walls is installed in substantial contact and continuous alignment with building envelope air barrier</p> <p>Breaks or joints in the air barrier are filled or repaired Air-permeable insulation is not used as a sealing material</p>
Ceiling/attic	<p>Air barrier in any dropped ceiling / soffit is substantially aligned with insulation and any gaps are sealed</p> <p>Attic access (except unvented attic), knee-wall door, or drop-down stair is insulated and sealed or in conditioned space</p>
Walls	Corners and headers are insulated; junction of foundation and sill plate is sealed
Windows and doors	Space between window / door jambs and framing is sealed – No stuffing of fiberglass insulation is allowed
Rim joists	Rim joists are insulated and include an air barrier following included reference to best practice example
Floors (including above-garage cantilevered floors)	<p>Insulation is installed to maintain permanent contact with the area it is insulating</p> <p>Air barrier is installed at any exposed edge of insulation</p>
Crawl space walls	<p>Insulation is permanently attached to walls. No poly or vinyl faced insulation. Follow included reference to best practice example</p> <p>Exposed earth in unvented crawl spaces is covered with Class I vapor barrier with overlapping joints taped</p>
Shafts, penetrations	Duct shafts, utility penetrations, knee walls, and flue shafts opening to exterior or unconditioned spaces are sealed
Narrow cavities	Batts in narrow cavities are cut to fit, or narrow cavities are filled with sprayed / blown insulation. Narrow cavities are defined as 4 inches wide or less

COMPONENT	CRITERIA
Garage separation	Air sealing is provided between the garage and conditioned spaces and door assembly meets fire code.
Recessed lighting	Recessed light fixtures are airtight, ICAT rated, & sealed to drywall  Exception – fixtures in conditioned space
Plumbing and wiring	Insulation is placed between the exterior wall and the pipes  Batt insulation is cut to fit around wiring and plumbing, or sprayed / blown insulation extends behind piping and wiring
Shower / tub on exterior wall	Showers and tubs on exterior walls have insulation and an air barrier separating them from the exterior wall
Electrical / phone box	Air barrier extends behind boxes or air-sealed-type boxes are installed on exterior walls
Common wall	Air barrier is installed in common wall between dwelling units and air infiltration is treated like an exterior wall – common walls need to be considered as an exterior wall for air sealing
HVAC register boots	HVAC register boots that penetrate building envelope are sealed to subfloor or drywall
Fireplace	Fireplace walls include an air barrier

Energy Performance Table

ITEM	MINIMUM REQUIRED
<b>Cooling</b>	Proper Sizing (Manuals D, J, & S Required) – matched to code and using modeling software appropriate to project type – commercial / residential. Modeling must be completed by ACCA approved software: i.e. Wrightsoft, Elite, Adtek. Use the most recent addition (not including spreadsheets and abridged versions) – <a href="http://www.acca.org/standards/approved-software">www.acca.org/standards/approved-software</a>
Electric, Forced-air, central air conditioners	16 SEER / EER 13.0
Electric, Forced-air, air-source heat pumps	16 SEER / EER 13.0
Electric, ground-source heat pumps (closed loop)	18 EER
Electric, ground-source heat pumps (open loop)	18 EER
Mini-Split Heat Pump	15 SEER / EER 12.5 / HSPF 8.5
<b>Heating</b>	Proper Sizing (Manual D, J & S Required)
Natural gas, forced-air furnaces	96 AFUE
Natural gas, boilers	90 AFUE
Electric, Forced-air, air-source heat pumps	9 HSPF
Electric, ground-source heat pumps (closed loop)	4 COP
Electric, ground-source heat pumps (open loop)	4 COP

ITEM	MINIMUM REQUIRED
Ground-source heat pumps and boilers piping insulation	Insulated to a minimum of R-3
HVAC System Performance	Current Version of ENERGY STAR HVAC Commissioning Checklist completed by contractor and verified by HERS Rater.
HVAC Installation Space	HVAC equipment needs to be installed in an easily accessible space for maintenance and repair.
<b>Thermostat</b>	Install a programmable communicating thermostat (Smart Thermostat). A whole building or dwelling unit thermostat that can be monitored and controlled remotely. The thermostat shall include the capability to set back or temporarily operate the system and provide remote access to maintain zone temperatures of not less than 55°F to not greater than 85°F.
<b>Ductwork</b> – Sheet metal ducts (supply & return) and joints – insulated to R-8 in unconditioned spaces / sealing each joint using mastic and/or UL 181 approved tapes or sealants	All ductwork should be installed in conditioned spaces. If ductwork is located outside conditioned space, then ductwork shall be tested for 4% or less tested duct leakage to unconditioned spaces.
<b>Thermal Envelope</b>	The project must pass a thermal bypass inspection checklist performed by a third-party Energy Rater certified by RESNET or Building Performance Institute. The following must be sealed & or blocked with an air barrier: All joints, seams & penetrations / windows, doors & skylights / openings between window & door assemblies & jambs & framing / utility penetrations / dropped ceiling or chases adjacent to the thermal envelope / knee walls / walls & ceilings between units / attic access openings / rim joist junction / other sources of infiltration (must use rigid blocking). Infiltration levels must be equal to or less than 3 ACH50 determined by using a blower door test.
<b>Insulation</b>	
Ceiling	R-49 – Raised Heel Truss with minimum 14” heel height
Wood Frame Wall	Zone 5 = Minimum of R-13 cavity + R-5 continuous rigid exterior foam. Zone 6 = Minimum of R-20 cavity + R-5 or R-13 cavity + R-10 continuous rigid exterior foam insulation.
Mass Frame Wall	Zone 5 = R-13/17, Zone 6 = R-15/20
Floor, above unheated space	Minimum R-30 (must fill cavity depth)
Basement Wall (entire)	Zone 5 & 6 = R-15/19
Rim Joist	R-19 + 5 continuous rigid exterior foam
Slab	R-10 next to slab edge – down to footing on walk-outs and under slab minimum of R-10 4’ back and minimum of R-5 rest of slab. Slab insulation to be verified by third-party Energy Rater.

ITEM	MINIMUM REQUIRED
Crawl Space	R-15 continuous / R-19 cavity (must be conditioned / crawl space floor covered with minimum 10 mil poly)
Thermally Isolated Sunrooms	Min. R-24 in ceilings / min. R-13 in side walls
<b>Windows ENERGY STAR</b> (must have NFRC sticker for residential windows)	0.30 U-factor
<b>Doors</b>	R-5
<b>Water Heaters</b>	Water heater needs to be installed in an easily accessible space for maintenance and repair. Natural gas water heaters must be power vented.
Natural gas, up to 60 gallons	.67 EF and Energy Star qualified
Natural gas, 60-80 gallons	.85 TE and Energy Star qualified
Natural gas tankless	.82 EF and Energy Star qualified
Natural gas condensing	90% TE and Energy Star qualified
Electric	.95 EF and Energy Star qualified
Electric Heat Pump	2.0 EF or greater and Energy Star qualified
Circulation Hot Water Systems	Hot water piping shall be insulated to a minimum of R-3 & have an automatic manual switch to turn off the pump when the system is not in use
<b>Mechanical Ventilation</b>	Required to be balanced and tested to meet current edition of ASHRAE 62.2 (residential), ASHRAE 62.1 (commercial)
<b>Lighting</b>	
Recessed Lighting	Shall be sealed & ICAT-rated & labeled to meet ASTM E 283 & gasketed
High-Efficiency Lamps	All lighting shall be LED
<b>Attic Doors &amp; Hatches</b> (from conditioned to unconditioned spaces)	Gasketed / barrier of a minimum of 18" tall / minimum of R-40 rigid foam on scuttle top. Must include fire rated assembly.
<b>Fireplaces</b>	Wood-burning fireplaces shall have gasketed doors & outdoor combustion air / insulated / blocked & sealed
<b>Energy Performance Ratings</b>	
Residential New Construction	Minimum HERS Index = 61
Residential Gut Rehabilitation	Minimum HERS Index = 85, Minimum HERS Index = 100 if building was built before 1980 and walls are made only of brick / masonry
Residential Moderate Rehabilitation	Minimum HERS Index = 85, Minimum HERS Index = 100 if building was built before 1980
Commercial New Construction	Meet or exceed ASHRAE 90.1-2013 Appendix G by 10 percent
Commercial Substantial Rehabilitation	Meet or exceed ASHRAE 90.1-2013 Appendix G by 10 percent



ITEM	MINIMUM REQUIRED
Commercial Moderate Rehabilitation	Meet or exceed ASHRAE 90.1-2013
Residential and Commercial Mixed-Use Buildings	Entire building must meet or exceed ASHRAE 90.1-2013 Appendix G by 10 percent. Residential units must also meet applicable residential requirements above.

Projects greater than 100,000 cubic feet of heated or cooled interior space must complete the Iowa required [Energy Review Form](#) identified in Code of Iowa chapter 103A.19(6)

### **Sampling Protocol** **Energy Star Projects**

Projects seeking to achieve Energy Star certification, must follow the Energy Star program sampling protocol.

### **Non-Energy Star Projects**

To ensure quality design and installation of HVAC systems and overall performance of each unit while maintaining overall project affordability, projects following an energy performance option other than Energy Star certification, may use the following sampling protocol.

The below stated sampling protocol is per building, not per total project. For buildings with 12 or fewer units all units must have the contractor complete the current version of ENERGY STAR HVAC Commissioning Checklist and performance verified by HERS Rater.

Buildings with more than 12 units must have the contractor complete the current version of ENERGY STAR HVAC Commissioning Checklist and performance verified by HERS Rater for 12 units plus 10 percent of the number of units beyond 12. For example, 100 units = first 12 units + (10 percent \* 88 additional units) = 20.8 units (21 units to be tested). The third-party energy rating firm shall select the sample units to be tested and shall consider and use unit floor plan and location when selecting sample test units. Units included in the sample set must be a variety of unit types, direction and location in the building. Examples: Exterior & Interior, first floor, second floor, third floor. If one of the units in the sample set fails to pass verification or achieve the mandatory HERS Index, corrections shall be made, and four additional units tested. If one or more of the additional units fails to pass the SAVE test or achieve the mandatory HERS Index, seven additional units shall be tested. If failures still occur in this sample set the sampling option for the project will be forgone and all units must be tested and shall pass the mandatory criteria.

- \*Thermal inspections cannot be sampled. Every unit must receive an inspection to ensure the thermal enclosure, air barrier and insulation criteria have been achieved. This is to be verified by the third- party energy rating firm. using the current ENERGY STAR “Thermal Enclosure System Rater Checklist.”

### High Performance Construction Best Practices

The following images are provided as recommended best practices to achieve a high-performance energy envelope that will assist the project meeting the energy performance requirements listed above. See additional images for best practices for air sealing key points in Appendix G.

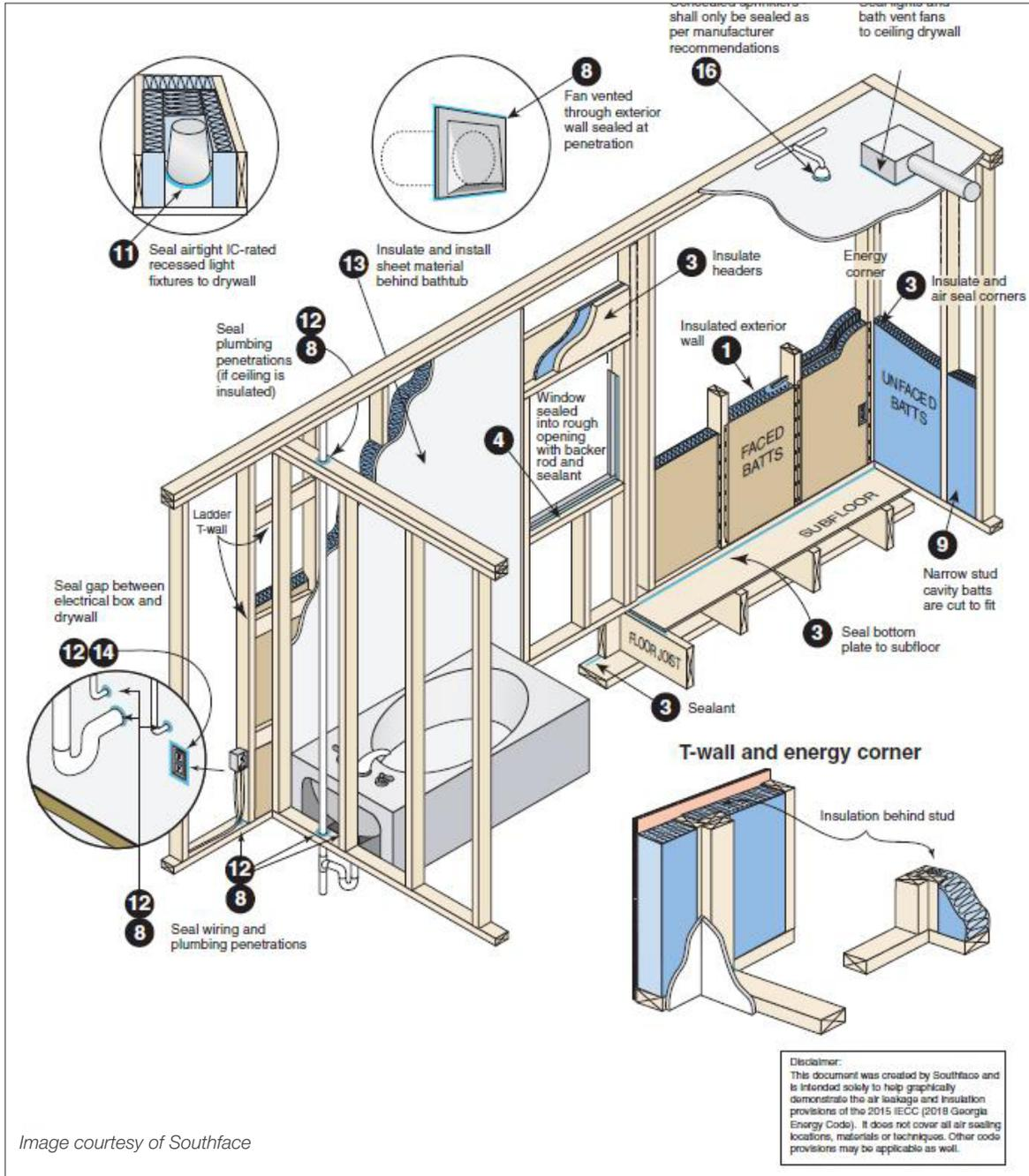
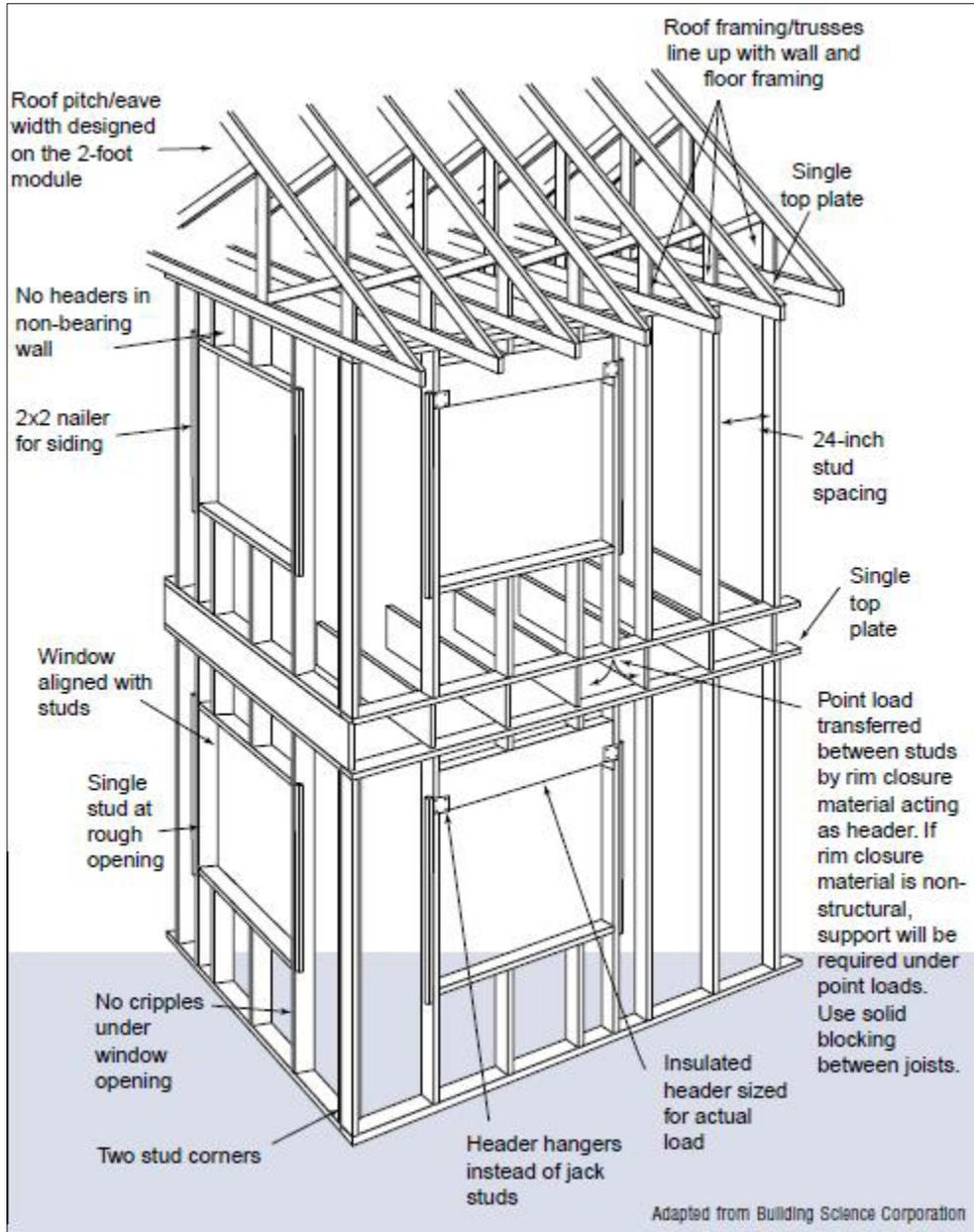
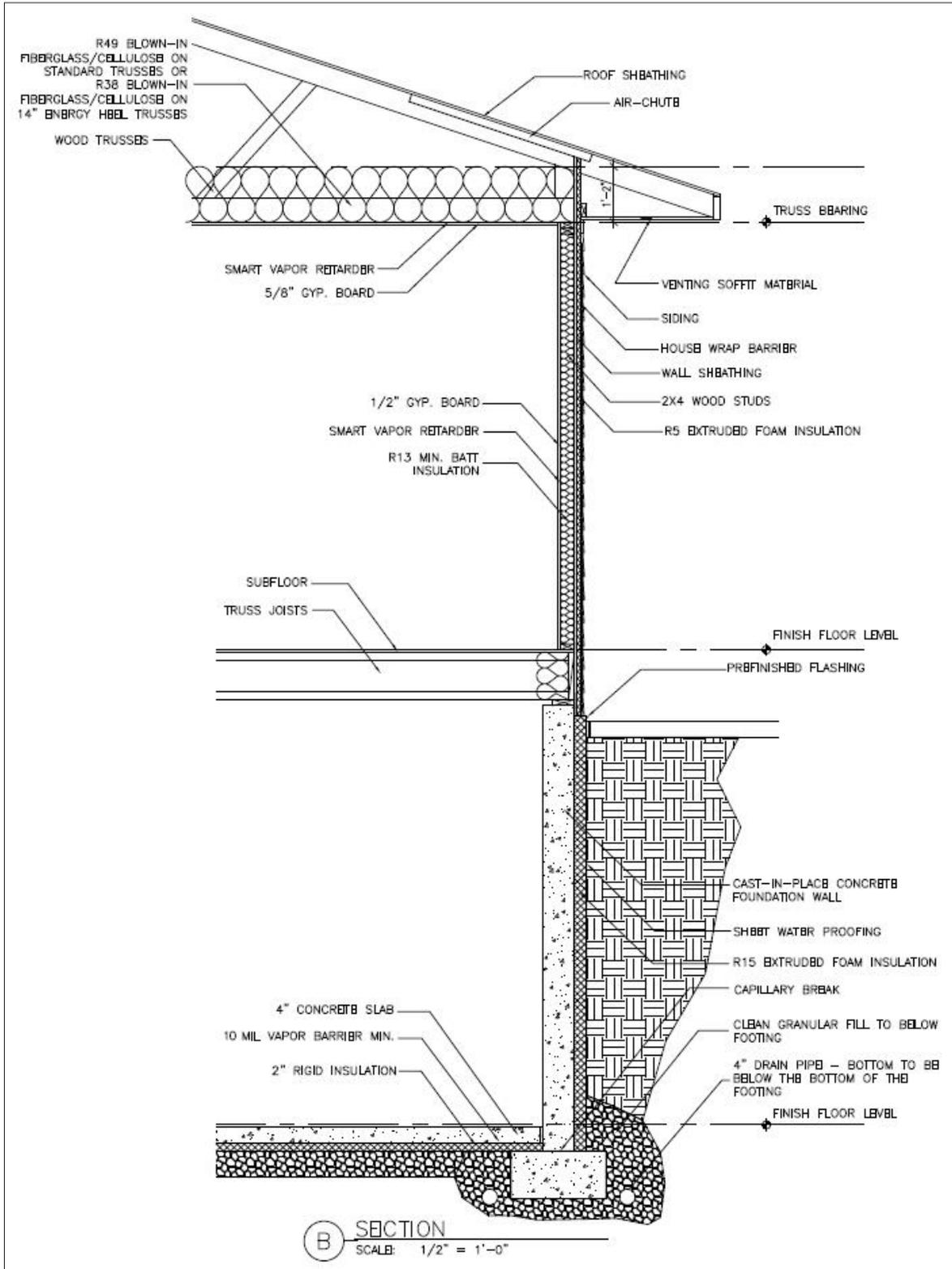

Image courtesy of Southface

Disclaimer: This document is intended solely to help graphically demonstrate the air leakage provisions of section 402.4 of the 2012 IECC. It does not cover all air sealing locations or techniques. Other code provisions may be applicable as well.



Advanced Framing



Model Wall Assembly (climate zone 5)



Insulating Sheathing

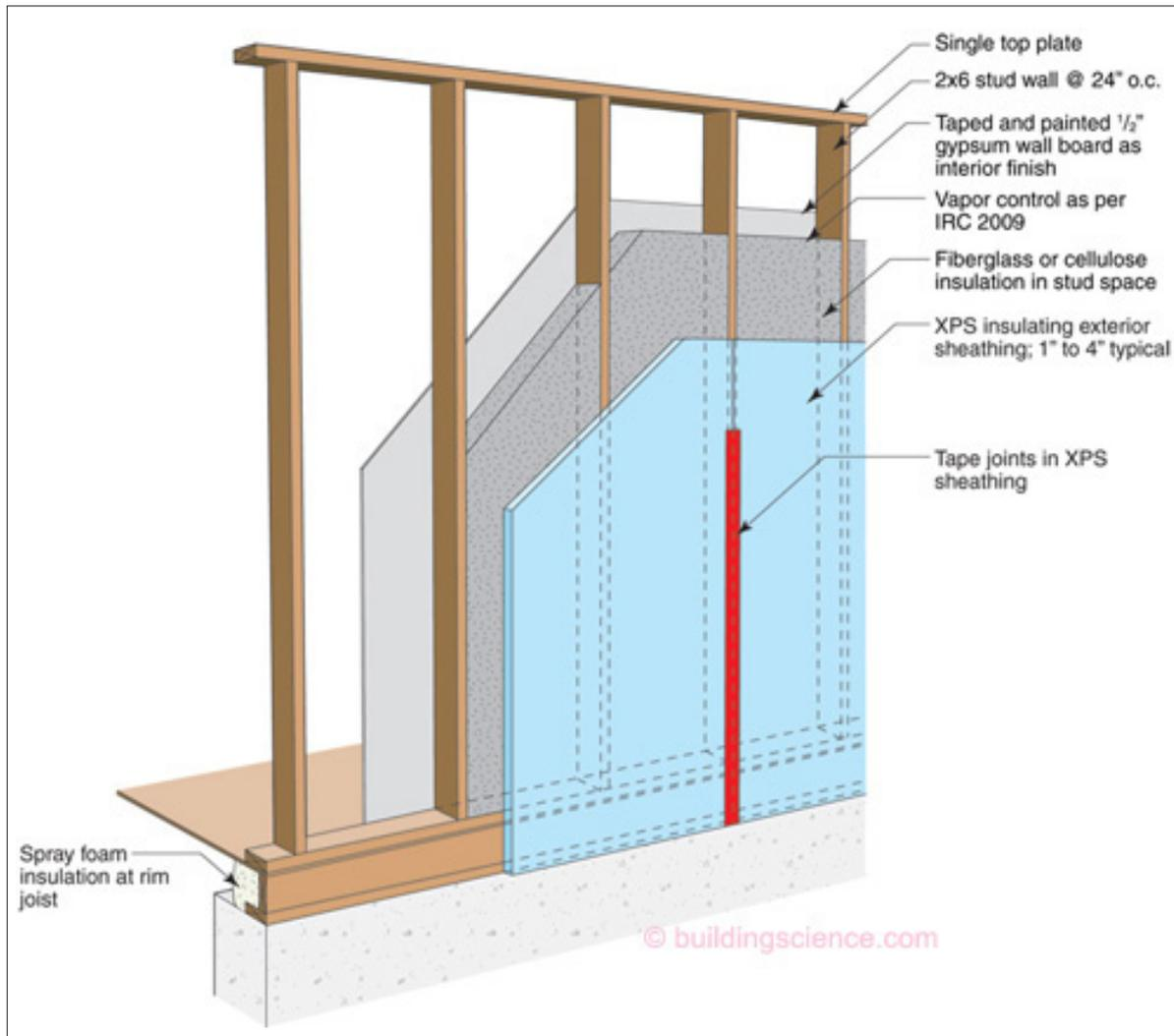

High R-Value Wall

## RECOMMENDATIONS

- Project teams should engage a HERS rater as early in their project design stage as possible. Find a HERS rater here: [www.energystar.gov/partnerlocator](http://www.energystar.gov/partnerlocator). For additional information: [www.resnet.us/choose-the-right-contractor](http://www.resnet.us/choose-the-right-contractor)
- Review and follow the ENERGY STAR Certified New Homes partnership and training guidelines found at [www.energystar.gov/homes](http://www.energystar.gov/homes)
- During the design phase, work with the HERS rater to set energy-efficiency goals that comply with the energy performance requirements above.
- Contact your project's local energy supplier for available project energy design assistance and energy performance and equipment rebates.

## RESOURCES

- To identify a Home Energy Rater in your area: [www.energystar.gov/partnerlocator](http://www.energystar.gov/partnerlocator)
- Hire a project design team with documented experience in designing and overseeing construction of high performing buildings. The Iowa chapter of the American Institute of Architects maintains a searchable directory of architectural firms specializing in sustainable design as well as historic preservation. [www.aiaiowa.org/search/custom.asp?id=1701](http://www.aiaiowa.org/search/custom.asp?id=1701)
- Building Science Corporation provides a wealth of high performance building related resources, including a key word searchable database of research, publications, and best practices. [buildingscience.com](http://buildingscience.com)
- For more information regarding ENERGY STAR Certified New Homes: [www.energystar.gov/homes](http://www.energystar.gov/homes)

## 5.1A BUILDING PERFORMANCE STANDARD

### CRITERIA FOR NEW CONSTRUCTION OF THE FOLLOWING PROJECT TYPES:

- *Single-family detached and attached homes*
- *Multifamily buildings with four dwelling units or fewer*
- *Multifamily buildings with three stories or fewer*
- *Multifamily buildings with up to five stories, where each dwelling unit has its own heating, cooling and hot water system*

## MANDATORY

### REQUIREMENTS

#### OPTION 1

A RESNET certified third-party (HERS) Rater must verify energy efficiency achievement meeting the performance levels identified in the Energy Performance Requirements in Criterion 5.1 above. Use IEDA provided scope of work template when issuing request for proposals for HERS Rater.

During the design phase, work with a qualified HVAC contractor knowledgeable of building science principles and RESNET certified Home Energy Rater (HERS Rater) to set energy efficiency goals that comply with the performance levels in Criterion 5.1. After the project team has decided on an “energy package,” incorporate the finalized building performance thresholds and measures into the project plans and specs and/or scope of work. Solicit an experienced HERS Rater to create and implement a verification plan during the construction processes and conduct building performance inspections, post-construction testing and final reporting.

When submitting reimbursement claims to the Iowa Economic Development Authority, have the project construction manager, or their representative, email pictures to [greenstreets@iowaeda.com](mailto:greenstreets@iowaeda.com) showing installation of floor/slab insulation, capillary break on footing, advanced framing, exterior rigid insulation, air sealing, and duct sealing. Utilize best practices such as pictured in Criterion 5.1 and Air Sealing Key Points images in Appendix G to achieve building high performance.

## OPTION 2

Certify each dwelling unit in the project through the ENERGY STAR New Homes program. Use the appropriate specification version of ENERGY STAR New Homes depending on when the project is permitted, when construction will be completed and local ENERGY STAR guidelines. To determine the appropriate specification version for each project: [www.energystar.gov/homes](http://www.energystar.gov/homes).

When submitting reimbursement claims to the Iowa Economic Development Authority, have the project construction manager, or their representative, email pictures to [greenstreets@iowaeda.com](mailto:greenstreets@iowaeda.com) showing installation of floor/slab insulation, capillary break on footing, advanced framing, exterior rigid insulation, air sealing, and duct sealing. Utilize best practices such as pictured in Criterion 5.1 and Air Sealing Key Points images in Appendix G to achieve building high performance.

## RATIONALE

ENERGY STAR Certified New Homes are independently verified to be energy-efficient and durable. These high-performance homes achieve energy savings in heating, cooling, hot water, lighting and appliance efficiencies, which improve resident comfort, reduce operating costs and decrease greenhouse gas emissions.

## RECOMMENDATIONS

- Project teams must engage a certified Home Energy Rating System (HERS) rater to certify any dwelling unit to ENERGY STAR New Homes. We recommend that project teams engage a HERS rater as early in their project design stage as possible. Find a HERS rater here: [www.energystar.gov/partnerlocator](http://www.energystar.gov/partnerlocator). For additional information: [www.resnet.us/choose-the-right-contractor](http://www.resnet.us/choose-the-right-contractor)
- Review and follow the ENERGY STAR Certified New Homes partnership and training guidelines found at [www.energystar.gov/homes](http://www.energystar.gov/homes)
- During the design phase, work with the HERS rater to set energy-efficiency goals that comply with ENERGY STAR Certified New Homes. You may either follow a prescriptive path with a pre-determined set of construction details, or you may follow a performance path by creating your own package of compliant measures through modeling completed by the HERS rater. With both paths, you must also incorporate all measures from the Inspection Checklists. After the project team has decided on a compliant energy package, build these measures into the project plans and specs, and work with the HERS rater to create and implement a verification plan throughout construction.

## RESOURCES

- See Resources for Criterion 5.1

## 5.1B BUILDING PERFORMANCE STANDARD

### CRITERIA FOR NEW CONSTRUCTION OF THE FOLLOWING PROJECT TYPES:

- *Multifamily buildings with four or five stories wherein each dwelling unit does not have its own heating, cooling and hot water system*
- *Multifamily buildings with six or more stories*

### MANDATORY

### REQUIREMENTS

#### OPTION 1

Certify the project through the ENERGY STAR Multifamily High Rise program (MFHR).

When submitting reimbursement claims to the Iowa Economic Development Authority, have the project construction manager, or their representative, email pictures to [greenstreets@iowaeda.com](mailto:greenstreets@iowaeda.com) showing installation of floor/slab insulation, capillary break on footing, advanced framing, exterior rigid insulation, air sealing, and duct sealing. Utilize best practices such as pictured in Criterion 5.1 and Appendix H to achieve building high performance.

#### OR

#### OPTION 2

First, follow the applicable ENERGY STAR MFHR modified performance path to demonstrate that the project will perform at least 25% better than the ASHRAE 90.1-2007 baseline code designated by the ENERGY STAR MFHR program. This baseline code is ASHRAE 90.1 per Appendix G; refer to the latest ENERGY STAR MFHR guidance to determine which version of ASHRAE 90.1 is applicable for your project. See [www.energystar.gov/index.cfm?c=bldrs\\_lenders\\_raters.nh\\_mfhr\\_prgm\\_reqs](http://www.energystar.gov/index.cfm?c=bldrs_lenders_raters.nh_mfhr_prgm_reqs) for additional information.

Second, for verification of the above measures, follow the LEED for Homes v4 EA Prerequisite: Minimum Energy Performance Midrise Prescriptive Commissioning Path.

When submitting reimbursement claims to the Iowa Economic Development Authority, have the project construction manager, or their representative, email pictures to [greenstreets@iowaeda.com](mailto:greenstreets@iowaeda.com) showing installation of floor/slab insulation, capillary break on footing, advanced framing, exterior rigid insulation, air sealing, and duct sealing. Utilize best practices such as pictured in Criterion 5.1 and Appendix H to achieve building high performance.

### RATIONALE

Buildings meeting the ENERGY STAR Multifamily High Rise program guidelines are designed to be energy-efficient and durable. These high-performance buildings achieve energy savings in heating, cooling, hot water, lighting and appliance efficiencies, which improve resident comfort, reduce operating costs and decrease greenhouse gas emissions.



## RECOMMENDATIONS

- Projects participating in the ENERGY STAR MFHR program are designed to perform at least 15% better than ASHRAE 90.1-2010/2012 IECC. All MFHR-certified projects must meet initial program requirements and be verified and field-tested according to the ENERGY STAR MFHR Testing and Verification Protocols.
- Review and follow the ENERGY STAR MFHR Certification Process and Training Resources found at [www.energystar.gov/mfhr](http://www.energystar.gov/mfhr) if certifying to that program.
- For MFHR certification, partner with ENERGY STAR ([www.energystar.gov/mfhr](http://www.energystar.gov/mfhr)) and work with a qualified Licensed Professional to meet program requirements. With the Licensed Professional, design the project to meet program requirements and submit a set of designs and a Project Application to EPA, then construct the project as designed, and test to ensure proper installation by following the ENERGY STAR MFHR Testing and Verification Protocols throughout construction. After the final inspection, the Licensed Professional will submit an As-Built Submittal to EPA. Once approved, EPA will notify the project team that the units in the building have earned the ENERGY STAR.
- If using the ENERGY STAR MFHR Performance Path, to calculate the energy performance target the project team must:
  - Identify a qualified professional who has experience with performing energy modeling per ASHRAE Standard 90.1, Appendix G. In the early design stage, the qualified professional should prepare the energy model and work with the integrative design team to identify cost-effective strategies for meeting the energy performance target.
  - Calculate the baseline building performance rating according to the EPA's Multifamily High Rise Simulation Guidelines building performance rating method, which is based on Appendix G of ANSI/ASHRAE/IESNA Standard 90.1-2007 (with errata but without addenda).
- Appendix G of Standard 90.1 is the method for calculating the baseline and projected energy consumption of a building through the Performance Path. This method includes all energy costs associated with the building project.
  - The baseline building performance standard (5.1b) can only be met through building performance improvements, and not through the addition of electric-generating renewable energy systems. However, other “renewable” technologies, such as solar domestic hot water collectors and geothermal H/AC systems (ground source heat pumps), can be included.

Examples of software that meet ASHRAE 90.1 Appendix G requirements include:

- DOE2      · TRACE      · eQuest      · HAP
- VisualDOE      · TRNSYS      · EZDOE      · EnergyPlus

## RESOURCES

- EPA's ENERGY STAR Multifamily High Rise program details, including the prescriptive and performance path guidelines and the testing and verification protocols. [www.energystar.gov/mfhr](http://www.energystar.gov/mfhr)
- LEED for Homes v4 EA Prerequisite: Minimum Energy Performance Midrise Prescriptive Commissioning Path. [www.usgbc.org/node/2611843?return=/credits](http://www.usgbc.org/node/2611843?return=/credits)
- See Resources for Criterion 5.1

## 5.1C BUILDING PERFORMANCE STANDARD

### CRITERIA FOR SUBSTANTIAL OR MODERATE REHABS OF THE FOLLOWING PROJECT TYPES:

- *Single-family detached and attached homes*
- *Multifamily buildings with four dwelling units or fewer*
- *Multifamily buildings with three stories or fewer*
- *Multifamily buildings with four or five stories, where each dwelling unit has its own heating, cooling and hot water system*

### MANDATORY

#### REQUIREMENTS

For each dwelling unit in the project types identified above follow the applicable Energy Performance Requirements in Criterion 5.1 and achieve a HERS Index score of 85 or less (see exception below).

The software used for the energy modeling during the design stage and to generate the HERS Index and certificate must be approved by RESNET. Any method or strategy, except for electric-generating renewable energy systems, can be implemented to satisfy the targeted minimum energy performance.

When submitting reimbursement claims to the Iowa Economic Development Authority, have the project construction manager, or their representative, email pictures to [greenstreets@iowaeda.com](mailto:greenstreets@iowaeda.com) showing installation of the following practices if applicable to the project — floor/slab insulation, capillary break on footing, advanced framing, exterior rigid insulation, air sealing, and duct sealing. Utilize best practices such as pictured in Criterion 5.1 and Appendix G to achieve building high performance.

Exception: Substantial rehabs of buildings with walls made only of brick/masonry that are three stories or fewer\* and built before 1980, as well as moderate rehabs of buildings that are three stories or fewer\* and built before 1980, are permitted to instead achieve a HERS Index score of 100 or less for each dwelling unit. \*or four or five stories, where each dwelling unit has its own heating, cooling and hot water system

#### RATIONALE

Dwelling units rehabilitated to a HERS Index score of 85 will achieve approximately 2009 IECC energy performance levels in heating, cooling, hot water, lighting and appliance efficiencies, which improve resident comfort, reduce operating costs and decrease greenhouse gas emissions.

Certain existing buildings undergoing rehabilitation are unable to achieve a HERS Index score of 85 without making drastic changes to the building envelope; these buildings will be permitted to achieve a HERS Index score of 100 (approximately 2006 IECC energy performance levels).

## RECOMMENDATIONS

- To achieve a HERS Index score of no more than 85 (or, if applicable, 100) at project completion, we recommend that project teams engage a HERS rater as early in their project design stage as possible. Find a HERS rater here: [www.energystar.gov/partnerlocator](http://www.energystar.gov/partnerlocator)  
For additional information: [www.resnet.us/choose-the-right-contractor](http://www.resnet.us/choose-the-right-contractor)
- The HERS rater will be responsible for:
  - conducting modeling to estimate energy usage based on project plans and specifications provided by the project team
  - conducting a mid-construction pre-drywall thermal enclosure, using the current ENERGY STAR “Thermal Enclosure System Rater Checklist”
  - verifying the final performance of the building with post-construction performance testing, including a blower door and duct blaster test of the home and /or units

## RESOURCES

- To identify a Home Energy Rater in your area: [www.energystar.gov/partnerlocator](http://www.energystar.gov/partnerlocator)
- List of software approved by Residential Energy Services Network (RESNET) to generate HERS Index score: [www.resnet.us/professional/programs/energy\\_rating\\_software](http://www.resnet.us/professional/programs/energy_rating_software)
- Building Performance Institute, Inc. (BPI): Develops standards for energy-efficiency retrofit work, certifies professional workers, and accredits BPI GoldStar Contractors: [www.bpi.org](http://www.bpi.org)
- Residential Energy Services Network (RESNET): A resource where residents can learn about the energy audit and rating process: [www.resnet.us](http://www.resnet.us)
- Enterprise Green Communities Single-Family Rehabilitation Specifications: A set of green single- family specifications for insulation, air sealing and other details that can be customized to your project: [www.enterprisecommunity.org/resources](http://www.enterprisecommunity.org/resources)
- The National Renewable Energy Laboratory has produced an air sealing fact sheet: [www.nrel.gov/docs/fy00osti/26446.pdf](http://www.nrel.gov/docs/fy00osti/26446.pdf)
- U.S. Department of Energy Building America program has produced a webinar on air sealing best practices and multifamily area separation walls: [energy.gov/eere/buildings/downloads/building-america-webinar-air-sealing-best-practices-and-code-compliance](http://energy.gov/eere/buildings/downloads/building-america-webinar-air-sealing-best-practices-and-code-compliance)
- See Resources for Criterion 5.1.

## 5.1D BUILDING PERFORMANCE STANDARD

### CRITERIA FOR SUBSTANTIAL OR MODERATE REHABS OF THE FOLLOWING PROJECT TYPES:

- *Multifamily buildings with four or five stories wherein each dwelling unit does not have its own heating, cooling and hot water system*
- *Multifamily buildings with six or more stories*
- *Commercial Buildings*
- *Nonprofit Buildings (non-residential)*
- *Mixed Use Commercial and Residential Buildings*

### MANDATORY

#### REQUIREMENTS

For each project type identified above follow the applicable Energy Performance Requirements in Criterion 5.1 Demonstrate that the energy performance of the completed building will be equivalent to ASHRAE 90.1-2013 using an energy model created by a qualified energy services provider according to Appendix G. This performance requirement shall only be met through building performance improvements, rather than through the addition of electric-generating renewable energy systems. Also, in order to ensure long-term optimal building performance and to better situate a building for withstanding power outages, prioritize envelope improvements over mechanicals and lighting.

When submitting reimbursement claims to the Iowa Economic Development Authority, have the project construction manager, or their representative, email pictures to [greenstreets@iowaeda.com](mailto:greenstreets@iowaeda.com) showing installation of the following practices if applicable to the project — floor/slab insulation, capillary break on footing, advanced framing, exterior rigid insulation, air sealing, and duct sealing. Utilize best practices such as pictured in Criterion 5.1 and Appendix G to achieve building high performance.

Exception: Substantial rehabs of buildings with walls made only of brick/masonry that are three stories or fewer\* and built before 1980, as well as moderate rehabs of buildings that are three stories or fewer\* and built before 1980, are permitted to instead achieve a HERS Index score of 100 or less for each dwelling unit. \*or four or five stories, where each dwelling unit has its own heating, cooling and hot water system

#### RATIONALE

Buildings rehabilitated to ASHRAE 90.1-2013 energy performance levels achieve energy savings in heating, cooling, hot water, lighting and appliance efficiencies, which improve resident comfort, lower operating costs and decrease greenhouse gas emissions.

#### RECOMMENDATIONS

- To demonstrate energy performance equivalent to ASHRAE 90.1-2013, contract with an energy services provider. We would recommend that the energy services provider be responsible for:
  - creating an energy model during the design stage of the project, with plans and specifications showing the building's projected energy performance
  - conducting a mid-construction pre-drywall thermal enclosure inspection
  - verifying the final performance of the building with performance testing

- Follow all envelope code requirements of ASHRAE 90.1 2013; otherwise meet the minimum whole building energy performance target that was calculated by the model.
- Appendix G of Standard 90.1-2013 is the method for calculating the baseline and projected energy consumption. This method includes all energy costs associated with the building project.
  - The baseline building performance standard (5.1d) can only be met through building performance improvements, and not through the addition of electric-generating renewable energy systems. However, other “renewable” technologies such as solar domestic hot water collectors and geothermal H/AC systems (ground source heat pumps) can be included.

Examples of software that meet ASHRAE 90.1 Appendix G requirements include:

- DOE2
- TRACE
- eQuest
- HAP
- VisualDOE
- TRNSYS
- EZDOE
- EnergyPlus

## RESOURCES

- For more information on ASHRAE 90.1-2013: [www.ashrae.org](http://www.ashrae.org)
- Enterprise Green Communities Multifamily Rehabilitation Specifications: A set of model green building specifications for Multifamily Rehab projects that includes details on insulation, air sealing and performance testing that can be customized for your project: [www.enterprisecommunity.org/solutions-and-innovation/green-communities/tools-and-services/construction-specifications](http://www.enterprisecommunity.org/solutions-and-innovation/green-communities/tools-and-services/construction-specifications)
- U.S. Department of Energy Building America program has produced a webinar on air sealing best practices and multifamily area separation walls: [energy.gov/eere/buildings/downloads/building-america-webinar-air-sealing-best-practices-and-code-compliance](http://energy.gov/eere/buildings/downloads/building-america-webinar-air-sealing-best-practices-and-code-compliance)
- See Resources for Criterion 5.1.

## 5.1E BUILDING PERFORMANCE STANDARD

### CRITERIA FOR NEW CONSTRUCTION OF THE FOLLOWING PROJECT TYPES:

- *Commercial Buildings*
- *Nonprofit Buildings (non-residential)*
- *Mixed Use Commercial and Residential Buildings*

### MANDATORY

### REQUIREMENTS

- Follow all applicable requirements and best practices in Criterion 5.1;
- Exceed the performance of ASHRAE 90.1-2013 Appendix G by 10 percent;
- Commission the building and its systems following one of the commissioning processes identified in the resources section below;
- For insulation values, all project types shall meet or exceed the values in Criterion 5.1, including the continuous exterior foam insulation to achieve a thermal break;
- Pass a slab insulation and pre-drywall thermal bypass inspection by a trained and certified third-party RESNET Energy Rater to verify proper sealing and insulation practices per the Energy Performance Table in Criterion 5.1;

- Use IEDA provided scope of work template when issuing request for proposals for HERS Rater;
- Submit completed to the Iowa Economic Development Authority, energy modeling information showing adherence to exceeding ASHRAE 90.1-2013 Appendix G by  $\geq 10$  percent, code certificate and thermal bypass checklist; and
- Projects greater than 100,000 cubic feet of heated or cooled interior space must complete the Iowa required Energy Review Form identified in Code of Iowa chapter 103A.19(6).

When submitting reimbursement claims to the Iowa Economic Development Authority, have the project construction manager, or their representative, email pictures to [greenstreets@iowaeda.com](mailto:greenstreets@iowaeda.com) showing installation of floor/slab insulation, capillary break on footing, advanced framing, exterior rigid insulation, air sealing, and duct sealing. Utilize best practices such as pictured in Criterion 5.1 to achieve building high performance.

## RESOURCES

- Use the commissioning process from one or more of these resources to complete the required commissioning:
  - ASHRAE Guideline 0-2013 The Commissioning Process and/or ASHRAE Guidelines 1.1-2007 and 1.5-2012: [www.techstreet.com/ashrae/standards/guideline-0-2013-the-commissioning-process?product\\_id=1870180](http://www.techstreet.com/ashrae/standards/guideline-0-2013-the-commissioning-process?product_id=1870180)
  - ASHRAE Standard 202-2013 The Commissioning Process for Buildings and Systems—the industry accepted Commissioning Standard: [www.techstreet.com/ashrae/standards/ashrae-202-2013?product\\_id=1862482](http://www.techstreet.com/ashrae/standards/ashrae-202-2013?product_id=1862482)
  - Whole Building Design Guide Building Commissioning: [www.wbdg.org/building-commissioning](http://www.wbdg.org/building-commissioning)
  - Leadership in Energy and Environmental Design (LEED) Fundamental Commissioning of the Building Energy Systems, [www.usgbc.org/credits/new-construction/v22/eap1?view=language](http://www.usgbc.org/credits/new-construction/v22/eap1?view=language), in accordance with LEED for New Construction 2.2 Reference Guide;
- U.S. Department of Energy Building America program has produced a webinar on air sealing best practices and multifamily area separation walls: [energy.gov/eere/buildings/downloads/building-america-webinar-air-sealing-best-practices-and-code-compliance](http://energy.gov/eere/buildings/downloads/building-america-webinar-air-sealing-best-practices-and-code-compliance)
- Advanced Building Core Performance Guide is a “direct, simplified approach to achieve predictable energy savings in small- to medium-sized buildings without the need for modeling”: [www.advancedbuildings.net/core-performance](http://www.advancedbuildings.net/core-performance)
- Building Science Corporation provides a wealth of information on Optimum Value Engineering (Advanced Framing) to reduce framing material costs and improve wall performance: [buildingscience.com/documents/enclosures-that-work/high-r-value-wall-assemblies/copy\\_of\\_advanced-frame-wall-construction](http://buildingscience.com/documents/enclosures-that-work/high-r-value-wall-assemblies/copy_of_advanced-frame-wall-construction)
- APA – The Engineered Wood Association provides for free the “Advanced Framing Construction Guide”: [www.apawood.org/advanced-framing](http://www.apawood.org/advanced-framing)
- Residential Energy Services Network (RESNET) certifies and provides guidance and oversees quality assurance in home rating services: [www.resnet.us](http://www.resnet.us)
- See Resources for Criterion 5.1

## 5.2A ADDITIONAL REDUCTIONS IN ENERGY USE

### OPTIONAL | 5 - 12 POINTS

#### REQUIREMENTS

Design and construct a building that is projected to be at least 5% more efficient than what is required of the project by Criteria 5.1a–e:

**New Construction, projects following Criterion 5.1a:** 5 optional points for HERS Index score 5 lower than required; additional 1 optional point for each additional 1-point decrease in HERS Index score, up to maximum of 12 total optional points.

**New Construction, projects following Criterion 5.1b:** 5 optional points for 5% greater efficiency than required; additional 1 optional point for each additional 1% greater efficiency, up to maximum of 12 total optional points.

**Substantial and Moderate Rehab, projects following Criterion 5.1c:** 5 optional points for HERS Index score of 5 lower than required; additional 1 optional point for each additional 1-point decrease in HERS Index score, up to a maximum of 12 total optional points.

**Substantial and Moderate Rehab, projects following Criterion 5.1d:** 5 optional points for 5% greater efficiency than required; additional 1 optional point for each additional 1% great efficiency, up to maximum of 12 total optional points.

**New Construction, projects following Criterion 5.1e:** 5 optional points for 5% greater efficiency than required; additional 1 optional point for each additional 1% great efficiency, up to maximum of 12 total optional points.

These additional reductions in energy use must be captured by energy conservation measures associated with improved building component systems and not through the addition of electric- generating renewable energy systems. See Criterion 5.7b for renewable energy points. Projects following the prescriptive path of Criteria 5.1a–5.1e are not eligible for these points. Projects acquiring points through Criterion 5.2b are not eligible for these points.

#### RATIONALE

Improvements in building energy performance result in utility cost savings from more efficient heating, cooling, hot water, lights and appliances, which improve residents' comfort, lower operating costs and decrease greenhouse gas emissions. From a resilience standpoint, a highly energy- conserving building envelope will help to ensure that habitable temperatures will be maintained in the event of extended loss of power or interruptions in heating fuel (passive survivability).

#### RECOMMENDATIONS

Using the baseline energy model created in Criteria 5.1a– 5.1e, analyze, identify and adopt energy improvements to achieve additional energy reductions beyond the mandatory levels.

#### RESOURCES

The DOE Building Technologies Office offers free research publications, tools, webinars and newsletters on cost-effective, energy-efficient building strategies. [energy.gov/eere/buildings/building-technologies-office](https://energy.gov/eere/buildings/building-technologies-office)

## 5.2B ADVANCED CERTIFICATION: NEARING NET ZERO

### OPTIONAL | 12 POINTS

#### REQUIREMENTS

Certify the project in a program that requires advanced levels of building envelope performance such as Passive House Institute US (PHIUS), Living Building Challenge and/or DOE Zero Energy Ready Home. Projects acquiring points through this criterion are not eligible for points through Criterion 5.2a.

#### RATIONALE

These complementary whole building certification programs emphasize strategies that aggressively reduce whole building energy loads, reducing the need to heat and cool, reducing utility bills, reducing associated greenhouse gas emissions, and increasing project capacity to sustain habitability during loss of power.

#### RECOMMENDATIONS

Each of these programs requires a significant commitment to ensure significant levels of project performance. Begin strategizing how to achieve your project goals through dual certification with these programs as early in the integrative design process as possible.

#### RESOURCES

- Passive House Institute US (PHIUS): PHIUS is committed to making high-performance passive building the mainstream market standard. A Passive House is a set of design principles and a quantifiable performance standard applied to any building project, producing radically less energy needs, unparalleled comfort and supreme air quality. [www.passivehouse.us](http://www.passivehouse.us) and [www.phaus.org](http://www.phaus.org)
- Living Building Challenge Net Zero Energy Building Certification: Net Zero Energy Building Certification is a program operated by the International Living Future Institute using the structure of the Living Building Challenge. Net Zero Energy Building Certification verifies that the building is truly operating as claimed, provides a platform for the building to inform other efforts throughout the world and accelerate the implementation of restorative principles, and celebrates a significant accomplishment and differentiates those responsible for the building's success in this quickly evolving market. [living-future.org/netzero](http://living-future.org/netzero)
- DOE Zero Energy Ready Home: The DOE Zero Energy Ready Home is a program that builds upon ENERGY STAR for Homes, along with proven Building America innovations and best practices. These homes are third-party verified, meet all DOE Zero Energy Ready Home National Program Requirements, and follow provisions from the Consolidated Renewable Energy Ready Home (RERH) checklist for climates with significant solar insolation. [www.energy.gov/eere/buildings/zero-energy-ready-home](http://www.energy.gov/eere/buildings/zero-energy-ready-home)

## 5.3 SIZING OF HEATING AND COOLING EQUIPMENT

### MANDATORY

#### REQUIREMENTS

Size and select heating and cooling equipment in accordance with the Air Conditioning Contractors of America (ACCA) Manuals D, J, and S or ASHRAE handbooks.

Seal all ductwork with mastic or an approved UL 181 listed sealant. Insulating all supply ducts is recommended.

#### RATIONALE

Appropriately sized equipment can save money, ensure adequate dehumidification and prevent short-cycling that can lead to premature motor default.

#### RECOMMENDATIONS

- The HVAC contractor generates a Manual J load calculation to determine the heating and cooling loads of a particular project. A room-by-room Manual J is recommended, in order to properly determine room-by-room airflows best suited for the space's associated heating and cooling loads. A Manual S is used to determine which space heating and cooling equipment best match the load of the project calculated per Manual J. The Manual J accounts for factors such as the dwelling unit's solar orientation, window design and insulation R-value, installation quality, and building air leakage. Consult [www.acca.org/standards/software](http://www.acca.org/standards/software) for a list of software programs reviewed by ACCA to perform Manual J calculations.
- Consider locating heating and cooling equipment and the distribution system within the building envelope in order to reduce thermal distribution losses. Do not locate air handler or ductwork within the garage space (see Criterion 7.9 for more information).

#### RESOURCES

- Air Conditioning Contractors of America, Manuals J: Residential Load Calculation and Manual S: Residential Equipment Selection. [www.acca.org/standards](http://www.acca.org/standards)
- Air Conditioning Contractors of America, "HVAC Quality Installation Specification: Residential and Commercial Heating, Ventilating, and Air Conditioning Applications": The site also includes links to various articles and other ANSI and ACCA standards. [www.energystar.gov/ia/home\\_improvement/home\\_contractors/qispec.pdf](http://www.energystar.gov/ia/home_improvement/home_contractors/qispec.pdf)
- California Energy Commission, Procedures for HVAC System Design and Installation: This site provides an overview of good practices for designing and installing the HVAC system, as well as detailed strategies and measures for the "house as a system" approach to construction. [www.energy.ca.gov/efficiency/qualityhomes/procedures.html](http://www.energy.ca.gov/efficiency/qualityhomes/procedures.html)
- For additional information on duct sealing details: [www.energystar.gov/campaign/heating\\_cooling/duct\\_sealing/benefits](http://www.energystar.gov/campaign/heating_cooling/duct_sealing/benefits)

## 5.4 ENERGY STAR APPLIANCES

### IF PROVIDING APPLIANCES

#### MANDATORY

#### REQUIREMENTS

If providing appliances, install ENERGY STAR clothes washers, dryers, dishwashers and refrigerators.

If appliances will not be installed or replaced at this time, specify that, at the time of installation or replacement, ENERGY STAR models must be used via Criterion 8.1 Building Operations & Maintenance (O&M) Manual and Plan and Criterion 8.4 Occupant and Property Staff Orientation.

When the energy performance of the home is modeled to produce a HERS Index, the model should include the appliances and the HERS Index should reflect this.

#### RATIONALE

ENERGY STAR products meet strict energy-efficiency criteria set by EPA. These products reduce utility costs and greenhouse gas emissions.

#### RECOMMENDATIONS

The specifications of the installed appliances should be reflected in the energy modeling building input data report.

#### RESOURCES

- For bulk orders of ENERGY STAR products, use the web-based purchasing tool “Quantity Quotes”: This site connects purchasing groups with suppliers. [www.quantityquotes.net](http://www.quantityquotes.net)
- When preparing project specifications, find ENERGY STAR product information, including model numbers and savings calculators: [www.energystar.gov/products/certified-products](http://www.energystar.gov/products/certified-products)

## 5.5 LIGHTING

### MANDATORY

#### REQUIREMENTS

##### General

For all permanently installed lighting fixtures, install high-efficacy lighting LEDs per the International Code Council.

Recessed light fixtures (recessed cans): If recessed light fixtures are used anywhere in the project, install ENERGY STAR-qualified LED lamps. All recessed light fixtures must be Insulation Contact Air-Tight (ICAT) models.

##### Common Area Lighting

Building common spaces must use LED bulbs and be controlled by occupancy sensors or automatic bi-level lighting controls.

**Emergency Lighting**

Any new exit signs shall consume 5 watts or less. Fixtures located above stairwell doors and other forms of egress shall contain a battery backup feature. Photoluminescent exit signs may be used.

**Exterior Lighting**

100% of outdoor lighting must use LED bulbs, and lamps must be ENERGY STAR–certified when that certification is available for the product category.

All exterior lighting must be a Dark-Sky–approved “Friendly Fixture” and have motion sensor controls, integrative photovoltaic cells, photosensors or astronomic time-clock operation.

Note: Exterior emergency lighting and lighting required by code for health and safety purposes are exempt.

**RATIONALE**

Energy reductions through efficient lighting products contribute to lower utility costs and lower greenhouse gas emissions. Automatic lighting controls can significantly reduce lighting energy use. Battery backup in emergency lighting features allows for ease of egress during power blackouts.

**RECOMMENDATIONS**

- Consider incorporating daylighting practices throughout your project. Include controlled admission of natural light as well as a daylight-responsive lighting control system.
- Review ENERGY STAR product and design information regarding fixture and bulb selection and design.
- Incorporate stairwell skylights as a multi-purpose design feature, providing light, egress and ventilation.
- Install occupancy sensors in closets and rooms that will be occupied only intermittently. If installed in restrooms, position occupancy sensors to recognize the presence of someone in a toilet stall.
- Ensure that stairway lighting is consistent with or better than building corridor lighting to encourage use.
- Design outdoor lighting to eliminate light trespass from the project site and to minimize impact on nocturnal environments.
- Design outdoor lighting to meet IES guidelines (Lighting for Exterior Environments, IESNA publication, RP-33-1999).

**RESOURCES**

- For more information on lighting design and product selection: [www.energystar.gov/lighting](http://www.energystar.gov/lighting)
- The Lighting Research Center: This university-based, independent lighting research and education group provides objective and timely information about lighting technologies and applications, and about human response to light: [www.lrc.rpi.edu](http://www.lrc.rpi.edu)
- Whole Building Design Guide, Daylighting: [www.wbdg.org/resources/daylighting.php](http://www.wbdg.org/resources/daylighting.php)
- Illuminating Engineering Society of North America’s Recommended Practice Manual: Lighting for Exterior Environments includes lighting design guidelines: [www.ies.org/store/recommended-practices-and-ansi-standards/lighting-for-exterior-environments](http://www.ies.org/store/recommended-practices-and-ansi-standards/lighting-for-exterior-environments)
- International Dark-Sky Association (IDA) is a recognized authority on light pollution. Information on Dark-Sky–approved fixtures can be found online at: [www.darksky.org/outdoorlighting](http://www.darksky.org/outdoorlighting)

## 5.6 ELECTRICITY METER

*EXCEPT FOR SINGLE-ROOM OCCUPANCY AND DESIGNATED SUPPORTIVE HOUSING DWELLING UNITS*

**OPTIONAL | 6 POINTS**

### *REQUIREMENTS*

Install individual or submetered electric meters for all dwelling units.

### *RATIONALE*

Providing information to residents on the cost and usage associated with the electricity consumption in their unit may reduce energy use. Owners being cognizant of per dwelling unit energy consumption can use a proactive operations and maintenance approach, addressing outlier conditions in real-time.

### *RECOMMENDATIONS*

Individual metering and /or submetering should be specified in the Integrative Design stage, tracked through O&M procedures, and shared with residents.

## 5.7A PHOTOVOLTAIC/SOLAR HOT WATER READY

**OPTIONAL | 4 POINTS**

### *REQUIREMENTS*

Orient, design, engineer, wire and /or plumb the development to accommodate installation of photovoltaic (PV) or solar hot water system in the future.

Minimum required south-facing exposure:

- Single-Family and Low-Rise Buildings: 250 aggregated square feet for photovoltaic and 60 aggregated square feet for solar water heating of unobstructed roof area that is oriented within +/- 45 degrees of true south
- Mid- and High-Rise Multifamily Buildings: a minimum of 30% of aggregated unobstructed roof area that is oriented within +/- 45 degrees of true south
- If projects plan to install this equipment on the roof, demonstrate that there are still 20 years of useful life in the roof.

### *RATIONALE*

Designing for the future installation of photovoltaics or solar hot water systems allows a building owner the flexibility to transition to increased energy generation through renewable energy sources, as resources become available. Installation of renewable energy systems is a hedge against rising costs for purchased energy.

## RECOMMENDATIONS

- At the least, consider designing stand-alone laundry buildings for multifamily properties as solar water heating ready.
- When designing a photovoltaic or solar hot water ready system, include the following in the project plans and specifications (as applicable to each technology):
  - Site map showing that the building(s) have a southern orientation and unobstructed access to sunlight
  - A design schematic of the future solar array, indicating the south face, slope and any rooftop equipment that could obstruct the array
  - The type of roof to be installed (e.g., asphalt, standing seam metal, tile)
  - The future location within the building for the inverter
- For solar hot water, run piping from the designed or current location of the water heater up to the prospective solar hot water collectors.
- Work with an engineer to calculate that the roof can carry the dead load of the solar equipment and withstand the wind loads.
- Determine if the roof has a warranty and if the placement of the solar equipment voids the warranty.
- General Contractor, PV and /or solar hot water contractor must document the information on the roof load, location of conduit and piping, and the potential location of the dash box. GC, PV and solar hot water contractor should provide documentation to building owner and manager.
- Design roof and plumbing vents so be installed in a way that does not obstruct future renewable energy system installation.
- The first cost of PV can be high, but grants and subsidies are available in many states.

## RESOURCES

- EPA Renewable Energy Ready Homes (RERH): The RERH Specifications were developed by the U.S. Environmental Protection Agency (EPA) to educate builders on how to assess and equip new homes with a set of features that make it easier and less expensive for homeowners to install solar energy systems after the home is constructed: [www.energystar.gov/index.cfm?c=rerh.rerh\\_index](http://www.energystar.gov/index.cfm?c=rerh.rerh_index)
- National Renewable Energy Laboratory, “Solar Ready Buildings Planning Guide,” NREL Technical Report (NREL/TP-7A2-46078): A paper published by NREL in December 2009 that details design guidelines and checklists for designing solar-ready buildings: [www.nrel.gov/docs/fy10osti/46078.pdf](http://www.nrel.gov/docs/fy10osti/46078.pdf)
- Database of State Incentives for Renewables & Efficiency (DSIRE): DOE and the North Carolina Clean Energy Technology Center developed this database to collect information on state financial and regulatory incentives (e.g., tax credits, grants and special utility rates) designed to promote the application of renewable energy technologies. DSIRE also offers additional features, such as preparing and printing reports that detail the incentives on a state-by-state basis: [www.dsireusa.org](http://www.dsireusa.org)
- Iowa Renewable Energy Association provides educational and policy resources to support renewable energy development: [irenew.org](http://irenew.org)
- Iowa Solar Energy Trade Association promotes the quality installation of solar arrays in Iowa: [www.iowaseta.org](http://www.iowaseta.org)

## 5.7B RENEWABLE ENERGY

### OPTIONAL | 10 POINTS MAXIMUM

#### REQUIREMENTS

Install photovoltaic (PV) panels or other electric-generating renewable energy source to provide a specified percentage of the project's estimated energy demand. Refer to the table below for the point structure.

	5%	10%	20%	30%	40%
Single-story / Single-family	—	—	6 points	8 points	10 points
2–3 stories	—	6 points	8 points	10 points	—
4 stories or more	6 points	8 points	10 points	—	—

When calculating points for Criterion 5.7b, you may evaluate either the percentage of your project's total energy demand that is satisfied by a renewable energy source or the percentage of your project's water heating energy demand that is satisfied by a renewable energy source. Demonstrate the energy demand in question with the energy model your project team created for your project. Projects using a prescriptive path for Criterion 5.1 compliance will not be able to obtain points under Criterion 5.7b.

Projects may acquire points through Criterion 5.7b or Criterion 5.8b, but not both.

#### RATIONALE

Renewable energy reduces environmental impacts such as greenhouse gas emissions that are associated with energy sourced and produced from fossil fuels. Use of on-site renewable energy technologies can also result in energy cost savings.

#### RECOMMENDATIONS

- To provide a higher percentage of the project's estimated annual energy consumption with electric-generating renewable energy sources, focus on reducing the building's overall energy consumption in Criteria 5.1 and 5.2 with energy-efficiency measures, which are generally more cost-effective and longer lasting than renewables.
- Consider installing solar water heating systems for stand-alone laundry facilities in multifamily projects.
- Evaluate and review your maintenance contract to ensure that it includes all renewable systems and appropriate reviews and protocols for their maintenance, as well as the associated implications of roof-mounted systems.

## RESOURCES

- See Resources in Criterion 5.7a.
- Iowa Energy Center provides high performance building and renewable energy resources for Iowa such as the Iowa wind maps and solar maps: [www.iowaenergycenter.org](http://www.iowaenergycenter.org)
- Department of Energy, Office of Energy Efficiency and Renewable Energy: [energy.gov/eere/office-energy-efficiency-renewable-energy](http://energy.gov/eere/office-energy-efficiency-renewable-energy)
- American Solar Energy Society (ASES): ASES accelerates the development and use of solar and other renewable energy resources through advocacy, education, research and collaboration among professionals, policymakers and the public. [www.ases.org](http://www.ases.org)
- Florida Solar Energy Center (FSEC): This is a resource for basic information on types of photovoltaic solar electric systems, sizing, installation and system ratings. FSEC also has an industry resources page that includes its Photovoltaic System Design Course Manual, available at [secure.fsec.ucf.edu/fsecstore/do/product/Publications/GP-31](http://secure.fsec.ucf.edu/fsecstore/do/product/Publications/GP-31)
- National Renewable Energy Laboratory (NREL): Photovoltaic research at NREL provides a clearinghouse on all aspects of photovoltaic solar cell systems. [www.nrel.gov/pv](http://www.nrel.gov/pv)

## 5.8A RESILIENT ENERGY SYSTEMS: FLOODPROOFING OPTIONAL | 8 POINTS

### REQUIREMENTS

Conduct floodproofing, including perimeter floodproofing (barriers /shields), of lower floors.

Design and install building systems in such a way that, in the case of an emergency, the operation of these systems will not be grossly affected:

- Locate any and all central space and water heater equipment above design flood elevations.
- Locate the service disconnect at a readily accessible location above the design flood elevation.
- Locate at least one exit door above the design flood elevation.
- On plan sets, identify water entry points at basements and foundation walls and demarcate all penetrations, wall assemblies and doors/openings to ensure that future renovations do not compromise the integrity of floodproof construction.

### RATIONALE

When raising services, equipment and building portions above design flood level is not possible, dry floodproof (“bunkerize”) such services and spaces in order to better ensure building service in the case of a major flood event. The first and lower floors of buildings are often at risk because they are below flood level. Any essential building equipment should be located elsewhere, if flooding is a risk. Submersion of electrical utility services to the first point of switch disconnect is a safety concern and can lead to excessive or irreparable damage to both utility and building systems and increase the recovery time for such systems.

## RECOMMENDATIONS

- Project teams should, in accordance with Criterion 1.3, identify whether or not floods are of concern for the project in question. If not, it may be wise to choose different optional criteria instead of this one.
- Project teams will need to identify suitable space, with accessible entry, for locating this equipment above design flood elevation.
- See ASCE 24-05 Flood Resistant Design and Construction for further guidance regarding design and placement of building services.

## RESOURCES

- Building Resiliency Task Force Full Report, June 2013, Urban Green: [www.urbangreencouncil.org/content/projects/building-resiliency-task-force](http://www.urbangreencouncil.org/content/projects/building-resiliency-task-force)
- ASCE 24-05 Flood Resistant Design and Construction (2010): [www.fema.gov/media-library/assets/documents/14983?id=3515](http://www.fema.gov/media-library/assets/documents/14983?id=3515)
- Flood-Fight Handbook: Preparing for a Flood, 2009 Edition. U.S. Army Corp of Engineers, St. Paul District: [www.wsask.ca/Global/Lakes%20and%20Rivers/Flood%20Watch/Flood%20Fight%20Handbook.pdf](http://www.wsask.ca/Global/Lakes%20and%20Rivers/Flood%20Watch/Flood%20Fight%20Handbook.pdf)
- Enterprise's Multifamily Resilience Manual includes more than a dozen strategies and specific guidance for building property resilience in the event of an emergency, including floodproofing strategies: [www.enterprisecommunity.org/resources/ready-respond-strategies-multifamily-building-resilience-13356](http://www.enterprisecommunity.org/resources/ready-respond-strategies-multifamily-building-resilience-13356)

## 5.8B RESILIENT ENERGY SYSTEMS: ISLANDABLE POWER OPTIONAL | 4, 6 OR 8 POINTS

### REQUIREMENTS

Provide emergency power through an islandable photovoltaic (PV) system or an efficient and portable generator that will offer at least limited electricity for critical circuits during power outages. Size this system to satisfy the common space energy loads of the project.

#### OPTION 1 [8 points]

With PV systems, install inverters that provide limited access to solar-generated power during outages when the sun is shining.

OR

#### OPTION 2 [6 points]

Provide a PV system with battery storage and a system to switch to battery backup when the electric grid goes down.

OR

#### OPTION 3 [4 points]

Allow for the connection of an efficient portable generator to provide reliable power to critical systems in the case of an emergency power outage.

Projects may acquire points through Criterion 5.7b or Criterion 5.8b, but not both.

---

## RATIONALE

With more intense storms, flooding, wildfires and heat waves forecast with climate change, the frequency and duration of power outages may increase. So-called “islandable” electrical systems offer a significant level of resilience in such situations for supplying power to critical building systems.

## RECOMMENDATIONS

- Prioritize which electrical equipment will run on backup power so buildings can remain habitable during extended blackouts. Because cogeneration and solar power systems are always in use, they can be more reliable than generators that are turned on only during emergencies. In substantial rehab projects where the installation of a PV system is not feasible, a generator may be used as a backup power source.
- Prioritize emergency systems such as egress lighting, extended life safety systems (fire alarms), water, parking egress, improved habitability for mobility-impaired occupants (elevator car operation), small critical heating and cooling loads, and convenience power for building occupants (charging stations).
- At least one inverter manufacturer was producing a solar inverter in 2014 that allows access to solar-generated electricity when the utility grid is down and the sun is out, and other manufacturers will likely follow suit. Most grid-connected inverters do not function at all when the grid is down.
- A bi-modal solar system that can both feed power into the electric grid (net-metering) and shunt power to and from a battery bank offers great flexibility and resilience (including power at night during power outages).
- Where a permanent connection is being made for a portable generator, a disconnecting means and overcurrent protection should be provided at the point of connection. For a temporary generator hookup, the project should provide easy access to an electrical connection point. Connections shall be administered by qualified people who maintain and supervise the installation.

## RESOURCES

- Enterprise Community Partners, Multifamily Resilience Manual includes more than a dozen strategies and specific guidance for building property resilience in the event of an emergency, including backup power strategies. [www.enterprisecommunity.org/resources/ready-respond-strategies-multifamily-building-resilience-13356](http://www.enterprisecommunity.org/resources/ready-respond-strategies-multifamily-building-resilience-13356)
- Database of State Incentives for Renewables & Efficiency (DSIRE): DOE and the North Carolina Clean Energy Technology Center developed this database to collect information on state financial and regulatory incentives (e.g., tax credits, grants and special utility rates) designed to promote the application of renewable energy technologies. DSIRE also offers additional features, such as preparing and printing reports that detail the incentives on a state-by-state basis. [www.dsireusa.org](http://www.dsireusa.org)
- Building Resiliency Task Force Full Report, June 2013, Urban Green. [www.urbangreencouncil.org/content/projects/building-resiliency-task-force](http://www.urbangreencouncil.org/content/projects/building-resiliency-task-force)

## 5.9 ADVANCED FRAMING (OPTIMUM VALUE ENGINEERING)

### MANDATORY

#### REQUIREMENTS

- Follow Optimum Value Engineering best practices for all framing where possible
- Use truss uplift clips when installing trusses and do not attach ceiling drywall near corners.

#### RESOURCES

- Building Science Corporation provides a wealth of information on Optimum Value Engineering (Advanced Framing) to reduce framing material costs and improve wall performance: [buildingscience.com/documents/enclosures-that-work/high-r-value-wall-assemblies/copy\\_of\\_advanced-frame-wall-construction](https://www.buildingscience.com/documents/enclosures-that-work/high-r-value-wall-assemblies/copy_of_advanced-frame-wall-construction)
- APA – The Engineered Wood Association provides for free the “Advanced Framing Construction Guide”: [www.apawood.org/advanced-framing](http://www.apawood.org/advanced-framing)
- See advanced framing images and resource links below.

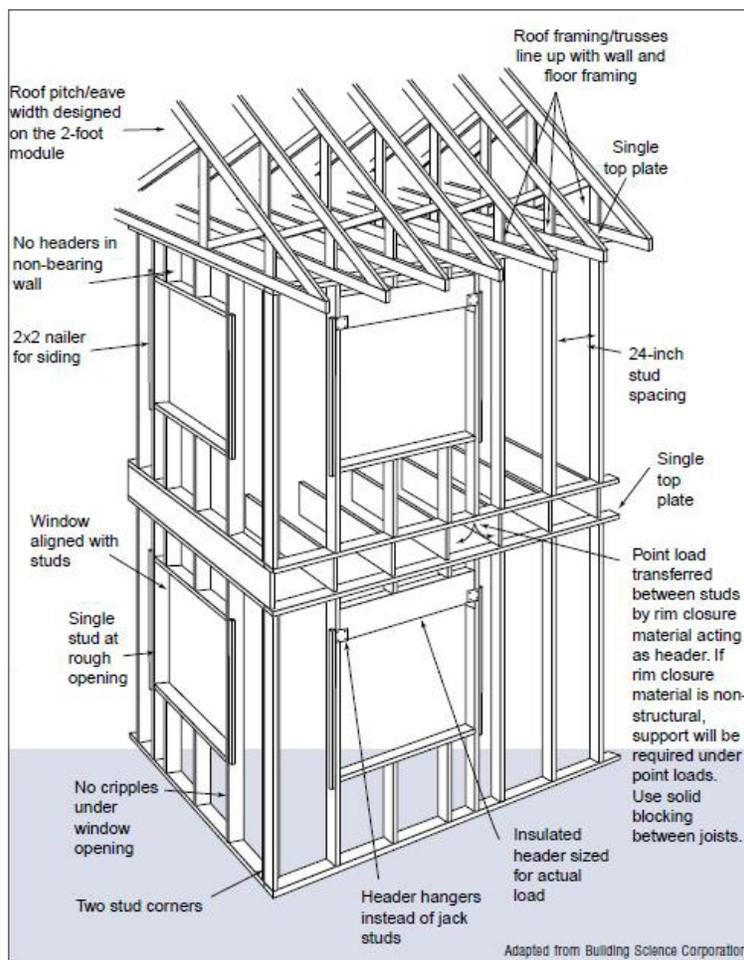

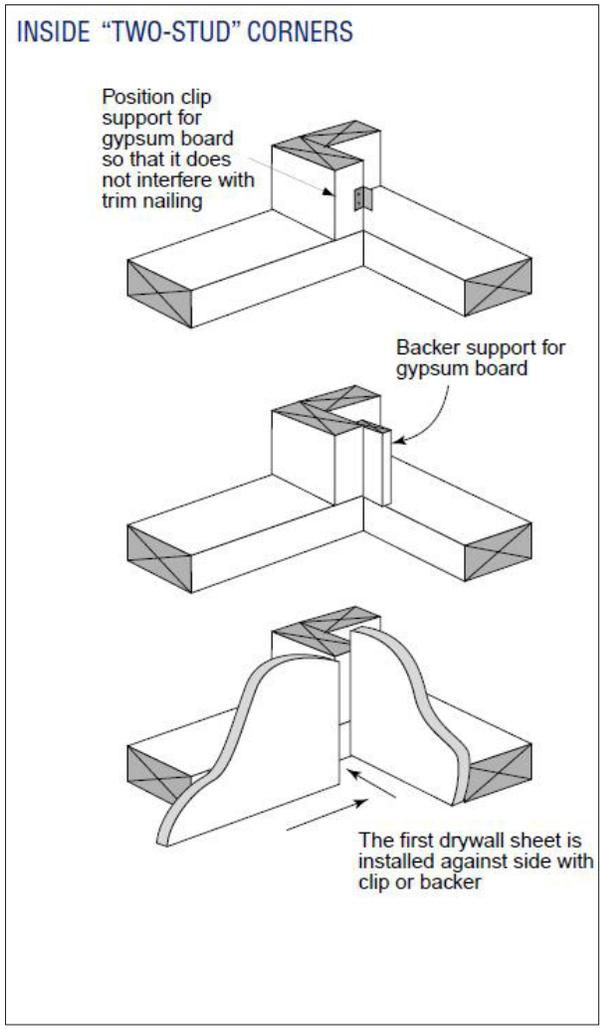

Two-Stud Corner

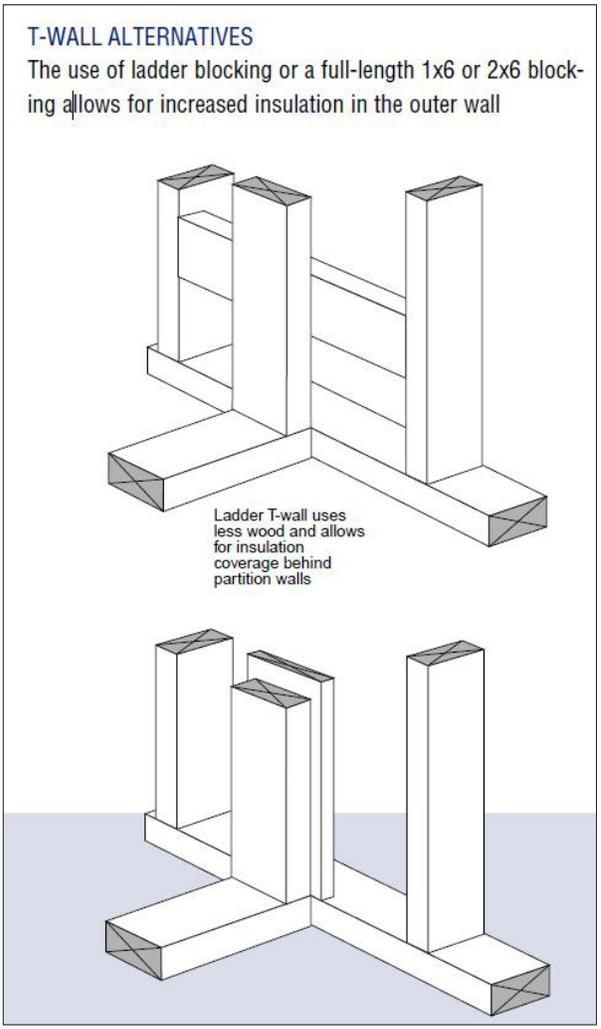

T-Wall

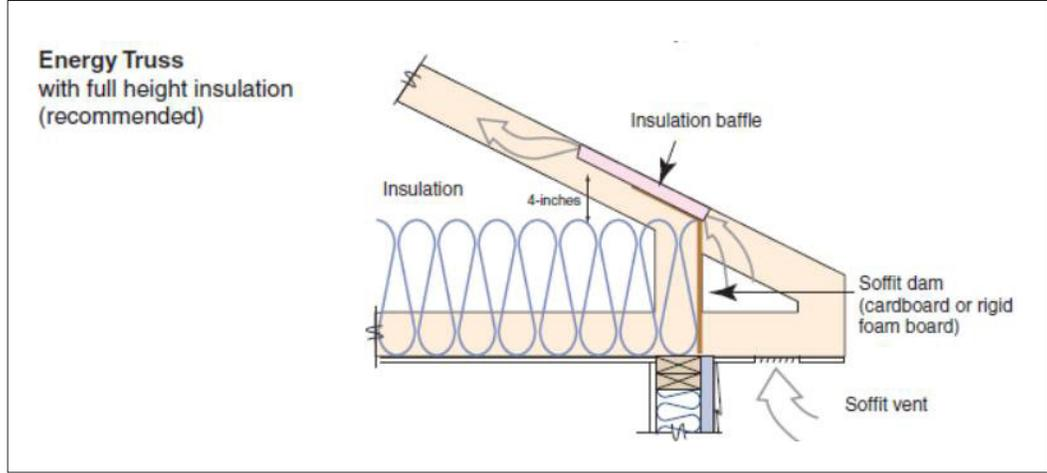

Raised-Heel Truss (Image: Building America Solution Center)

---

## 5.10 ADVANCED METERING INFRASTRUCTURE

### *OPTIONAL | 5 POINTS*

#### *REQUIREMENTS*

Site, design, engineer, and wire the development to accommodate installation of smart meters and /or be able to interface with smart grid systems in the future.

#### *RATIONALE*

Installation of smart meters allows for more control over a project's electricity use, to realize savings associated during off-peak times. Education on energy consumption habits will allow building occupants and owners to fully realize the environmental and economic benefits green housing offers.

#### *RESOURCES*

- U.S. Department of Energy provides a smart grid website with information on applicable projects and technologies: [www.smartgrid.gov](http://www.smartgrid.gov)
- U.S. Department of Energy, "The Smart Grid: An Introduction": [energy.gov/oe/downloads/smart-grid-introduction-0](http://energy.gov/oe/downloads/smart-grid-introduction-0)

INTRODUCTION CRITERIA  
CHECKLIST  
1 INTEGRATIVE DESIGN  
2 LOCATION +  
NEIGHBORHOOD FABRIC  
3 SITE IMPROVEMENTS  
4 WATER CONSERVATION  
5 ENERGY EFFICIENCY  
6 **MATERIALS**  
7 HEALTHY LIVING  
ENVIRONMENT  
8 OPERATIONS,  
MAINTENANCE  
+ OCCUPANT  
ENGAGEMENT  
APPENDIX

## MATERIALS

PURCHASING GREEN MATERIALS AND RECYCLING AND REUSING MATERIALS WHENEVER POSSIBLE CAN IMPROVE CONDITIONS FOR RESIDENT HEALTH, ENHANCE PROJECT DURABILITY, AND REDUCE WASTE AND DISPOSAL COSTS.

## 6.1 LOW/ NO VOC PAINTS, COATINGS AND PRIMERS MANDATORY

### REQUIREMENTS

All interior paints and primers must have volatile organic compound (VOC) levels, in grams per liter, less than or equal to the thresholds established by South Coast Air Quality Management District (SCAQMD) Rule 1113. Projects must follow the most recent revision available at time of product specification. For the latest rules: [www.aqmd.gov/home/regulations/rules](http://www.aqmd.gov/home/regulations/rules).

As of February 5, 2016, SCAQMD Rule 1113 thresholds are listed as:

PAINT TYPE	MAXIMUM VOC LIMIT
Primers and sealers	100 g/L
Coatings, flats and non-flats	50 g/L
Opaque floor coatings	50 g/L
Rust preventative coatings	100 g/L
Clear wood finishes	275 g/L

### RATIONALE

Interior paints, coatings and primers may release VOCs, particularly when newly applied. Exposure to individual VOCs and mixtures of VOCs can cause or aggravate health conditions, including allergies, asthma and irritation of the eyes, nose and airways; however, no health-based standards for indoor non-occupational exposure have been set.

### RECOMMENDATIONS

Avoid epoxy-based paints, even those that comply with VOC standards, as these contain the chemical Bisphenol A, which was identified by the EPA on March 29, 2010, as a “chemical of concern.” [www.epa.gov/sites/production/files/2015-09/documents/bpa\\_action\\_plan.pdf](http://www.epa.gov/sites/production/files/2015-09/documents/bpa_action_plan.pdf)

Products do not have to be certified by the Materials Performance Institute (MPI) or Green Seal to comply with this criterion, but they may be helpful in locating products that do not exceed the maximum VOC levels.

### RESOURCES

- The Master Painters Institute (MPI) Green Performance Standard for Paints & Coatings GPS-2-08 list of products: [www.specifygreen.com/EvrPerf/EnvironmentalPerformance.html](http://www.specifygreen.com/EvrPerf/EnvironmentalPerformance.html)
- The Master Painters Institute (MPI) “Extreme Green” Paint Standard: [www.paintinfo.com/MPInews/ExtremeGreen\\_Jan2010.shtml](http://www.paintinfo.com/MPInews/ExtremeGreen_Jan2010.shtml)
- Green Seal: Provides information on environmentally preferable products and services: [www.greenseal.org/Home.aspx](http://www.greenseal.org/Home.aspx)

## 6.2 LOW/ NO VOC ADHESIVES AND SEALANTS

### MANDATORY

#### REQUIREMENTS

All adhesives and sealants (including caulks) must have volatile organic compound (VOC) levels, in grams per liter, less than or equal to the thresholds established by the South Coast Air Quality Management District (SCAQMD) Rule 1168. Projects must follow the most recent revision available at time of product specification. For the latest rules: [www.aqmd.gov/home/regulations/rules](http://www.aqmd.gov/home/regulations/rules).

As of January 7, 2005, SCAQMD Rule 1168 thresholds are listed as:

VOC LIMIT PRODUCT TYPE	(G / L)
Indoor carpet adhesives	50
Carpet pad adhesives	50
Outdoor carpet adhesives	150
Wood flooring adhesives	100
Rubber floor adhesives	60
Subfloor adhesives	50
Ceramic tile adhesives	65
VCT and asphalt tile adhesives	50
Drywall and panel adhesives	50
Cove base adhesives	50
Multipurpose construction adhesives	70
Structural glazing adhesives	100
Single-ply roof membrane adhesives	250
Structural wood member adhesive	140
Architectural sealants, including caulk	250

#### RATIONALE

Interior adhesives and sealants may release VOCs, particularly when wet. Exposure to individual VOCs and mixtures of VOCs can cause or aggravate health conditions, including allergies, asthma and irritation of the eyes, nose and airways; however, no health-based standards for indoor non-occupational exposure have been set.

#### RECOMMENDATIONS

- Many construction adhesives are not capable of adhering at temperatures below 40°F. Projects located in cold climates only may be exempted from the required low-VOC adhesives and sealants if they prove problematic due to this reason. In this instance, please identify in the project submittal documents if other adhesives and /or sealants were needed and at what stage of construction the project team was unable to use required low-VOC products.
- Avoid epoxy-based caulks and epoxy-based sealants, as these contain Bisphenol A, which was listed on March 29, 2010, by the EPA as a “chemical of concern.”  
[www.epa.gov/sites/production/files/2015-09/documents/bpa\\_action\\_plan.pdf](http://www.epa.gov/sites/production/files/2015-09/documents/bpa_action_plan.pdf)

## RESOURCES

- Green Seal is a national organization that offers a labeling program to identify products meeting greener, higher performance standards: [www.greenseal.org](http://www.greenseal.org)
- Green Building Supply is a supplier focused on providing greener supplies to the construction industry and homeowner: [www.greenbuildingsupply.com/Paints-Coatings-Caulks-Sealants-Adhesives](http://www.greenbuildingsupply.com/Paints-Coatings-Caulks-Sealants-Adhesives)

## 6.3 RECYCLED CONTENT MATERIAL

### OPTIONAL | 3 POINTS MAXIMUM

#### REQUIREMENTS

Use building materials that feature recycled content.

The building material must make up 75% (by weight or cost) of a project component, and must be composed of at least 25% post-consumer recycled content or at least 50% post-industrial recycled content to achieve 1 point.

The following table provides a sample of project components and example building materials that a team can incorporate for optional points. Each building material that meets the requirements of this criterion is worth 1 point.

PROJECT COMPONENT	BUILDING MATERIAL (EXAMPLES)
Framing	Wood, concrete, steel, aluminum
Siding or masonry	Wood, metal, masonry
Flooring (non-structural)	Linoleum, cork, bamboo, reclaimed wood, sealed concrete, carpet
Paving	Cement slab (Urbanite)
Roofing	Wood shingles, asphalt shingles, tile, metal
Insulation	Fiberglass batt, cellulose, rigid panel
Sheathing	Plywood, OSB

*Note: The list above is a partial list and does not include all possible building materials; mechanical, electrical and plumbing components cannot be included in this calculation.*

#### RATIONALE

Use of building materials with recycled content reduces the negative environmental impact resulting from extraction and processing of virgin materials.

#### RECOMMENDATIONS

Consider the incorporation of recycled-content building materials from the early stages of project design.

## RESOURCES

- Building Green provides many articles about green building materials and practices: [www.buildinggreen.com](http://www.buildinggreen.com)
- EPA's Comprehensive Procurement Guidelines provides guidance on the procurement of many building materials you will be using in your project. Federally funded projects are often required to follow these procurement guidelines: [www.epa.gov/smm/comprehensive-procurement-guideline-cpg-program](http://www.epa.gov/smm/comprehensive-procurement-guideline-cpg-program)
- Green Building Supply is a supplier focused on providing greener supplies to the construction industry and homeowner: [www.greenbuildingsupply.com/Paints-Coatings-Caulks-Sealants-Adhesives](http://www.greenbuildingsupply.com/Paints-Coatings-Caulks-Sealants-Adhesives)
- Green Depot is a building material supplier that maintains a website of more environmentally friendly building materials: [www.greendepot.com/greendepot](http://www.greendepot.com/greendepot)
- Pharos maintains a building product library including health and environmental information: [www.pharosproject.net](http://www.pharosproject.net)

## 6.4 REGIONAL MATERIALS

### OPTIONAL | 4 POINTS MAXIMUM

#### REQUIREMENTS

Use products that were extracted, processed and manufactured within 500 miles of the project for a minimum of 50%, based on cost, of the building materials' value.

Building material types that can qualify for these points include the following (each material can qualify for 1 point):

- Framing materials
- Exterior materials (e.g., siding, masonry, roofing)
- Flooring materials
- Concrete / cement and aggregate material
- Drywall / interior sheathing materials

*Note: Mechanical, electrical and plumbing components cannot be included in this calculation.*

#### RATIONALE

Building materials that are extracted, processed and manufactured locally to the project site minimize the energy embedded in their transportation and contribute to the local economy.

#### RECOMMENDATIONS

Natural building materials that are approved by HUD or USDA can qualify for points under this measure.

#### RESOURCES

See Resources for Criterion 6.3.

## 6.5 CERTIFIED, SALVAGED AND ENGINEERED WOOD PRODUCTS

### OPTIONAL | 1 POINT

#### REQUIREMENTS

For at least 25% of all structural wood products, by cost or value, commit to using either:

- Structural wood products certified in accordance with the Forest Stewardship Council
- Salvaged wood products
- Engineered framing materials (note that these may not include urea formaldehyde-based binders (see Criterion 6.6))

$$\frac{\text{Sum of the value of all structural wood products that are certified, salvaged or engineered wood}}{\text{The value of all structural wood products}} = \text{Percentage of total wood products that meet this criterion}$$

#### RATIONALE

Less than 10% of the old growth forest remains in the United States. The use of salvaged wood and engineered wood products throughout your building for major structural components reduces the need to use old-growth lumber. Forest Stewardship Council-certified wood encourages forestry practices that are environmentally responsible.

#### RESOURCES

- For help in locating FSC-certified products, fill out the form found at [us.fsc.org](http://us.fsc.org). FSC will circulate it to certified companies, and these companies will contact you if they have the desired product(s) available.
- Building Materials Reuse Association: [www.bmra.org](http://www.bmra.org)
- Rainforest Alliance, “SmartGuide to Green Building Wood Sources”. This site lists U.S. suppliers, manufacturers and distributors of FSC-certified building products: [www.rainforest-alliance.org/find-certified](http://www.rainforest-alliance.org/find-certified)

## 6.6 COMPOSITE WOOD PRODUCTS THAT EMIT LOW/NO FORMALDEHYDE

### MANDATORY

#### REQUIREMENTS

All composite wood products (plywood, OSB, MDF, cabinetry, etc.) must be certified as compliant with California 93120 Phase 2. Or, if using a composite wood product that does not comply with California 93120 Phase 2, all exposed edges and sides must be sealed with low-VOC sealants, per Criterion 6.2.

#### RATIONALE

Composite wood products using formaldehyde-based binders will emit formaldehyde, which is a volatile organic compound. Symptoms of exposure vary widely and include a host of bodily reactions, including eye, nose and throat irritation, and difficulty breathing. Avoiding products that emit formaldehyde will reduce the quantity of harmful indoor air contaminants.

## RECOMMENDATIONS

- Make this requirement part of the specifications for subcontractor submittals. Obtain the manufacturer's specifications to determine whether materials meet this requirement. Seek composite wood products compliant with California 93120 Phase 2. California 93120 is a regulation issued by the California Air Resources Board (CARB) limiting allowable formaldehyde emissions from composite wood products.
- Seek composite wood products with no added formaldehyde-based compounds in the contents. Seek composite wood products with CARB No Added Formaldehyde (NAF) certification.
- If feasible, specify formaldehyde-free hardwood, plywood, particleboard or medium-density fiberboard.

## RESOURCES

- See Resources for Criterion 6.3 and 6.5.
- In July 2010, the U.S. Congress passed Public Law No: 111–199, the S. 1660: Formaldehyde Standards for Composite Wood Products Act, which updates the Toxic Substances Control Act of 1976 to align with the recent California legislation 93120. More information on Public Law No: 111–199 S.1660 can be found online at [www.govtrack.us/congress/bill.xpd?bill=s111-1660](http://www.govtrack.us/congress/bill.xpd?bill=s111-1660).

A summary of the Toxic Substances Control Act of 1976 can be found online at the EPA's website at [www.epa.gov/lawsregs/laws/tsca.html](http://www.epa.gov/lawsregs/laws/tsca.html).

- The California EPA Air Resources Board, FAQ on Composite Wood Products. [www.arb.ca.gov/toxics/compwood/implementation/faq.htm](http://www.arb.ca.gov/toxics/compwood/implementation/faq.htm)
- The California EPA Air Resources Board approved an Airborne Toxic Control Measure in April 2007 to reduce formaldehyde emissions from composite wood products, including hardwood plywood, medium-density fiberboard and particleboard (Title 17, California Code of Regulations 93120-93120.12, or California 93120). More information can be found at: [www.arb.ca.gov/toxics/compwood/compwood.htm](http://www.arb.ca.gov/toxics/compwood/compwood.htm)
- Scientific Certification Systems (SCS): Offers an SCS Indoor Air Advantage + Formaldehyde Free Certification for composite wood products. [www.scs-certified.com/products/index.php](http://www.scs-certified.com/products/index.php)

## 6.7A ENVIRONMENTALLY PREFERABLE FLOORING

### MANDATORY

### REQUIREMENTS

#### Prohibited Locations

Do not install carpets in building entryways, laundry rooms, bathrooms, kitchens / kitchenettes, utility rooms or any rooms with floors that are in direct contact with the foundation slabs.

#### Products

Any hard surface flooring products must be either ceramic tile or solid unfinished hardwood floors, or must meet the Scientific Certification System's FloorScore program criteria (including pre-finished hardwood flooring).

All carpet products must meet the Carpet and Rug Institute's Green Label or Green Label Plus certification for carpet, pad and carpet adhesives.

## RATIONALE

New carpets, padding and adhesives also release VOCs that may pose health hazards to residents and workers. In addition, carpets trap dust and other allergens. Carpets have a short lifespan (studies suggest 3–5 years), and thus may need frequent replacement. More durable flooring options that last longer and wear better than carpet promote resource conservation through their longevity.

## RECOMMENDATIONS

- The use of reclaimed flooring is encouraged, and such flooring need not meet the FloorScore certification. Reclaimed wood flooring should be free of lead-based paint, and tiles should be free of asbestos.
- Throughout the home, consider non-carpet flooring alternatives such as natural linoleum, Forest Stewardship Council (FSC)–certified or salvaged hardwoods, cork, bamboo, ceramic or stone tile, or sealed concrete.
- Make this requirement part of the specifications for subcontractor submittals.

## RESOURCES

- The SCS FloorScore program website includes information about the program, as well as a list of certified products that is updated regularly. [www.scs-certified.com/iaq/floorscore.html](http://www.scs-certified.com/iaq/floorscore.html) and [www.rfci.com](http://www.rfci.com).
- The Carpet and Rug Institute maintains a list of manufacturers and products meeting the Green Label Plus standard. [www.carpet-rug.org/CRI-Testing-Programs/Green-Label-Plus.aspx](http://www.carpet-rug.org/CRI-Testing-Programs/Green-Label-Plus.aspx)
- For online comparison of flooring alternatives, see the Healthy Building Network’s Pharos Project. [www.pharosproject.net](http://www.pharosproject.net)

## 6.7B ENVIRONMENTALLY PREFERABLE FLOORING: THROUGHOUT BUILDING *OPTIONAL | 6 POINTS*

### REQUIREMENTS

Use non-vinyl, non-carpet floor coverings throughout each building in the project.

### RATIONALE

Natural and renewable alternative flooring materials have demonstrated environmental benefits, including low levels of volatile organic compounds (VOC) emissions and environmentally friendly production methods. These products are good substitutes for standard products linked with certain health hazards.

## RECOMMENDATIONS

- Whenever possible, select resilient flooring that has passed a California 01350 test (FloorScore, CHPS) or NSF/ANSI 332. For California 01350, give highest preference to those that pass the residential version of the test, as the residential test is more stringent.
- Use alternative flooring materials such as natural linoleum, ceramic tile, bamboo, cork or hardwood (especially salvaged wood).
- For basements, leave the slab exposed and stain with low-VOC material rather than providing any floor treatments.

## RESOURCES

- GreenSpec Directory, Building Green: The online GreenSpec Directory lists product descriptions for more than 2,000 environmentally preferable products. [www.buildinggreen.com/product-guidance](http://www.buildinggreen.com/product-guidance)
- Pharos Project, Healthy Building Network: The Pharos Project provides health and environmental data about the manufacture, use and end of life of building materials specified in a web-based tool. [www.pharosproject.net](http://www.pharosproject.net)

## 6.8 MOLD PREVENTION: SURFACES

### MANDATORY

#### REQUIREMENTS

Use materials that have durable, cleanable surfaces throughout bathrooms, kitchens and laundry rooms. Materials installed in these rooms should not be prone to deterioration due to moisture intrusion or encourage the growth of mold.

#### RATIONALE

The use of durable, cleanable materials in wet areas reduces the potential for damage due to moisture, reduces odors and potentially reduces health hazards to residents. These materials reduce long-term maintenance costs as well.

#### RECOMMENDATIONS

When possible, avoid using materials such as unsealed grout, which traps and holds moisture and can facilitate mold growth.

#### RESOURCES

- GreenSpec Directory, Building Green: The online GreenSpec Directory lists product descriptions for more than 2,000 environmentally preferable products. [greenspec.buildinggreen.com](http://greenspec.buildinggreen.com)
- GreenGuard Microbial Resistance Listing: [greenguard.org/en/CertificationPrograms/listingprograms\\_copy1/CertificationPrograms\\_microbialProgram.aspx](http://greenguard.org/en/CertificationPrograms/listingprograms_copy1/CertificationPrograms_microbialProgram.aspx)
- Building Green provides many articles about green building materials and practices: [www.buildinggreen.com](http://www.buildinggreen.com)

## 6.9 MOLD PREVENTION: TUB AND SHOWER ENCLOSURES

*Except for projects that do not have shower or bathroom work in scope*

### MANDATORY

### REQUIREMENTS

Use moisture-resistant backing materials such as cement board, fiber cement board or equivalent per ASTM #D3273 behind tub/shower enclosures. Projects using a one-piece fiberglass tub/shower enclosure are exempt from this requirement.

### RATIONALE

The use of moisture-resistant materials in wet areas reduces moisture buildup, diminishing the potential for indoor mold growth that may yield odors and pose health hazards to residents. Proper moisture detailing also improves durability.

### RECOMMENDATIONS

When possible, avoid using materials such as unsealed grout, which traps and holds moisture and can facilitate mold growth.

### RESOURCES

- American Society for Testing and Materials (ASTM) International: [www.astm.org](http://www.astm.org)
- GreenGuard Microbial Resistance Listing: [www.greenguard.org/en/CertificationPrograms/listingprograms\\_copy1/CertificationPrograms\\_microbialProgram.aspx](http://www.greenguard.org/en/CertificationPrograms/listingprograms_copy1/CertificationPrograms_microbialProgram.aspx)

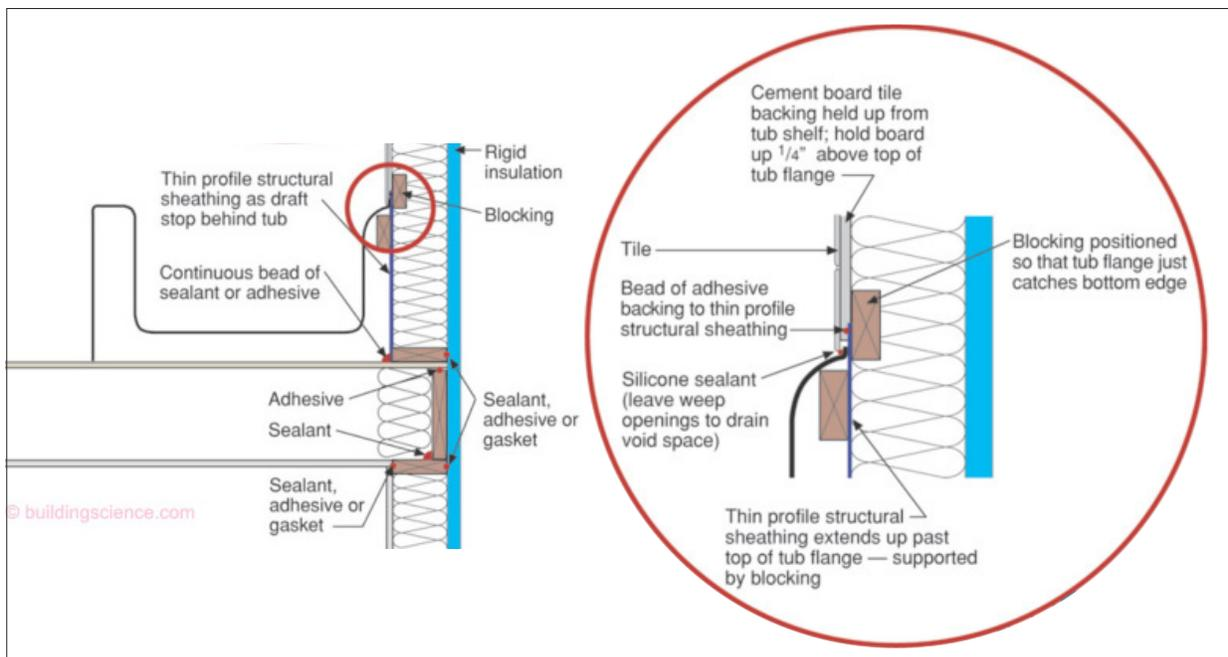

Draft Stopping and Air Barrier Tub Enclosure – Building Science Corporation

## 6.10 ASTHMAGEN-FREE MATERIALS

### OPTIONAL | 12 POINTS MAXIMUM

#### REQUIREMENTS

Do not install products that contain ingredients that are known to cause or trigger asthma. Key products to avoid are:

- *Insulation:* Do not use spray polyurethane foam (SPF) or formaldehyde-containing fiberglass batts. [4 points]
- *Flooring:* Do not use flexible vinyl (PVC) roll or sheet flooring or carpet backed with vinyl with phthalates. Do not use fluid applied finish floors. [4 points]
- *Wall coverings:* Do not use wallpaper made from vinyl (PVC) with phthalates or site-applied high-performance coatings that are epoxy- or polyurethane-based. [4 points]
- *Composite wood:* Use only ULEF (Ultra Low Emitting Formaldehyde) or NAF (No Added Formaldehyde) products for cabinetry, subflooring and other interior composite wood uses. [4 points]

For all material installation, be sure to closely follow the manufacturer's instructions. Many products require increased ventilation during installation and curing and should be applied/installed only when wearing appropriate safety gear, including, but not limited to, eye protection, respirators, gloves and skin protection. If building occupants are in place while potentially hazardous materials are being used, take extra precautions. Building occupants should be moved out of the building during the product application and for the duration of the curing period noted by the manufacturer.

#### RATIONALE

Research has shown that asthma may be triggered by certain chemicals that are widely used in certain building materials.

- Isocyanates are used in SPF, fluid applied floors and polyurethane high-performance coatings.
- Phthalates are used to make PVC/ vinyl flexible.
- BADGE, a binder material formed from Bisphenol A and epichlorohydrin, is used to make fluid applied floors and epoxy high-performance paints and other epoxy coatings applied on-site.
- Formaldehyde, a carcinogen, is used in binders for some fiberglass insulation batts and in plywood, particleboard and other composite woods.

#### RECOMMENDATIONS

- *Insulation:* Alternatives include recycled cotton, cellulose, wool and fiberglass with no binder. The majority of fiberglass insulation manufacturers now offer formaldehyde-free batts.
- *Flooring:* In place of vinyl or other PVC-based resilient flooring, use natural linoleum, rubber, cork, ceramic tile or pre-finished solid wood flooring. If you must use vinyl, ensure that it does not have phthalates. If possible, use a floor system that can feature mechanical attachments (e.g., nails, floating wood flooring) instead of glues. This approach makes flooring easier to recycle in the future.
- *Wall coverings and window treatments:* If you must use vinyl, ensure that it does not have phthalates.
- *Composite wood:* The most common alternative binder for wood is MDI, which is made with isocyanates. MDI is a lower hazard than formaldehyde as it cures more completely in the factory, but use alternative binders instead of MDI where possible. Seek resins that are more than half biobased. Many "soy-based" polyurethanes have only 5–20% soy and are mostly still made with asthma-causing isocyanates.

- Other areas to watch for:
  - PVC roofing membranes use phthalates as well. Use thermoplastic polyolefin (TPO) based roofing instead.
  - Many adhesives are epoxy-based (made with BADGE) or polyurethane-based (made with isocyanates). Minimize large volume usage of adhesives where possible and use lowest VOC types where needed.
  - Avoid furniture made with particleboard and other composite woods made with formaldehyde-based binders.
  - Carpet backings are sometimes made with flexible PVC or polyurethane. Choose carpets with phthalate-free PVC or other thermoplastic backings such as polyethylene or polypropylene. Avoid carpets and interior textiles with perfluorocarbons (PFCs, in particular PFBS and PFHxA).
- Alternatives may not be available for every product, but when possible prioritize those with low VOC content and emissions by receiving indoor air quality (IAQ) certifications that meet or exceed CA 01350 standard for VOC emissions, including SCS Indoor Advantage Gold and GreenGuard Gold or laboratory tests for the CDPH/EHLB Standard Method V1.1 – Residential scenario.

## RESOURCES

- The Pharos Project is an online building material selection tool that maintains listings of product contents disclosed by manufacturers and supplemented by Healthy Building Network (HBN) staff research, and identifies hazards associated with the contents. Products can be screened for asthmagens. [www.pharosproject.net](http://www.pharosproject.net)
- The Health Product Declaration (HPD) is a standardized format for manufacturer disclosure of product content, emissions and health hazards associated with the content. Manufacturers voluntarily use the format and may distribute it as they do MSDS's or Technical Data Sheets. The Health Product Declaration Collaborative maintains the HPD Standard and a list of tool providers who offer databases of HPDs. [hpdcollaborative.org](http://hpdcollaborative.org)
- “Full Disclosure Required: A Strategy to Prevent Asthma through Building Product Selection” is a report by the Healthy Building Network identifying asthmagens that are included as contents in building materials and making recommendations for product improvement. [healthybuilding.net/reports/14-full-disclosure-required-a-strategy-to-prevent-asthma-through-building-product-selection](http://healthybuilding.net/reports/14-full-disclosure-required-a-strategy-to-prevent-asthma-through-building-product-selection)
- The Carpet and Rug Institute maintains a list of manufacturers and products meeting the Green Label Plus standard. [www.carpet-rug.org/CRI-Testing-Programs/Green-Label-Plus.aspx](http://www.carpet-rug.org/CRI-Testing-Programs/Green-Label-Plus.aspx)

## 6.11 REDUCED HEAT-ISLAND EFFECT: ROOFING

### OPTIONAL | 5 POINTS

#### REQUIREMENTS

##### OPTION 1

Use an ENERGY STAR–certified roofing product for 100% of the roof area.

OR

##### OPTION 2

Install a “green” (vegetated) roof for at least 50% of the roof area and ENERGY STAR–certified roofing product for the remainder of the roof area.

## RATIONALE

Urban heat islands increase local air temperatures due to the absorption of solar energy by the built environment. Reducing the heat-island effect decreases energy consumption by decreasing loads on cooling systems, and it enhances resilience by reducing overheating of buildings in the event of power outages when air conditioning cannot operate.

## RECOMMENDATIONS

Avoid PVC membrane roofing, which is manufactured using phthalates, a chemical listed on December 30, 2009, by EPA as a “chemical of concern” to human health:

[www.epa.gov/assessing-and-managing-chemicals-under-tsca/phthalates](http://www.epa.gov/assessing-and-managing-chemicals-under-tsca/phthalates)

## RESOURCES

- Cool Roof Rating Council (CRRC), Directory of Rated Products: CRRC maintains a third-party rating system of radiative properties of roof surfacing materials. [coolroofs.org/products/results](http://coolroofs.org/products/results)
- U.S. Environmental Protection Agency, Heat Island Effect: This site contains information about heat-island effect, its social and environmental costs, and strategies to minimize its prevalence, including shading and coloration of hardscapes. [www.epa.gov/heatisland](http://www.epa.gov/heatisland)
- Lawrence Berkeley National Laboratory, Heat Island Group: The Lawrence Berkeley National Laboratory conducts research to find, analyze and implement solutions to minimizing heat-island effects; its current efforts focus on the study and development of more reflective surfaces for roadways and buildings. [eetd.lbl.gov](http://eetd.lbl.gov)
- Green Roofs for Healthy Cities is a nonprofit organization working to promote green roofs and walls. The organization maintains a website with green roof resources, including specifications: [www.greenroofs.org](http://www.greenroofs.org)
- GreenRoofs.com provides a robust website including a greenroofs 101 section with many resources: [www.greenroofs.com/Greenroofs101/index.html](http://www.greenroofs.com/Greenroofs101/index.html)

## 6.12 CONSTRUCTION WASTE MANAGEMENT

### MANDATORY OR *OPTIONAL* / 6 POINTS MAXIMUM

#### REQUIREMENTS

Commit to following a waste management plan that reduces non-hazardous construction and demolition waste through recycling, salvaging or diversion strategies.

**MANDATORY:** All projects must select either one pathway in OPTION 1 (a or b), two pathways in OPTION 2 (c – h), OR one pathway in OPTION 3 (i or j). No points are accrued for compliance with this mandatory requirement.

**OPTIONAL:** Projects may select additional pathways to accrue optional points. These pathways may be from within a different Option from what the project chose to comply with as mandatory. Not to exceed 6 optional points.

**OPTION 1:** Measured by Percentage (Mandatory: select one)

- a. Provide a waste plan that diverts 50% of the construction waste from the landfill. *[1 point]*
- b. Provide a waste plan that diverts 75% of the construction waste from the landfill. *[2 points]*

**OPTION 2:** Material Specific (Mandatory: select two)

- c. Recycle all cardboard. *[1 point]*
- d. Recycle all wood. *[1 point]*
- e. Recycle all drywall. *[1 point]*
- f. Recycle all metals. *[1 point]*
- g. Recycle all concrete, brick and asphalt. *[1 point]*
- h. Develop and implement a comprehensive efficient framing plan that minimizes all waste by design. *[1 point]*

**OPTION 3:** Minimizing Construction Waste — New Construction only (Mandatory: select one)

- i. Total construction waste to landfill or incinerator <2.5 lbs /SF of building *[1 points]*
- j. Total construction waste to landfill or incinerator <1.5 lbs /SF of building *[2 points]*

**RATIONALE**

Diverting construction debris, and recycling and reusing materials whenever possible, reduces waste and disposal costs. In addition, construction waste management reduces the project's impact on landfills.

**RECOMMENDATIONS**

- Investigate and document local options for recycling or reusing all anticipated major constituents of the project waste stream, including cardboard packaging and “household” recyclables.
- Create detailed framing plans or scopes of work and accompanying architectural details for use on the job site. Create a detailed cut list and lumber order prior to construction.
- For projects with limited access to recycling centers, consider waste diversion strategies such as using panelized walls and roof trusses to minimize total materials.
- Consider recycling carpet for rehab projects when carpeting is being removed. The specification language below may be customized and included to determine whether carpet recycling is feasible and cost-effective in your locale.
  - Vendor shall supply a price quote to recycle carpet and carpet components at 100%, 50% and 30% of product tonnage.
  - Property manager shall identify the carpet product and polymer, nylon, polypropylene (which is documented on carpet specification). This will enable the carpet vendor to ascertain the recyclability of the product.
- Some manufacturers of drywall and certain types of ceiling tiles will accept the return of old materials for re-processing.

## RESOURCES

- Iowa Waste Exchange is a no cost, non-regulatory program that helps identify markets for byproducts; [www.iowadnr.gov/Environmental-Protection/Land-Quality/Waste-Planning-Recycling/Iowa-Waste-Exchange-IWE](http://www.iowadnr.gov/Environmental-Protection/Land-Quality/Waste-Planning-Recycling/Iowa-Waste-Exchange-IWE)
- See the resources for Advanced Framing Criterion 5.9 to reduce generation of wood scraps.
- EPA has a website focused on best practices for construction waste management: [www.epa.gov/smm/best-practices-reducing-reusing-and-recycling-construction-and-demolition-cd-materials](http://www.epa.gov/smm/best-practices-reducing-reusing-and-recycling-construction-and-demolition-cd-materials)
- The National Association of Home Builders has produced “Residential construction Waste Management: A Builder’s Field Guide:” [infohouse.p2ric.org/ref/36/35527.pdf](http://infohouse.p2ric.org/ref/36/35527.pdf)
- U.S. Environmental Protection Agency maintains an information construction waste management website: [www.epa.gov/smm/sustainable-management-construction-and-demolition-materials](http://www.epa.gov/smm/sustainable-management-construction-and-demolition-materials)

## 6.13 RECYCLING STORAGE

### OPTIONAL | 3 POINTS

#### REQUIREMENTS

Provide separate bins for the collection of trash and recycling for each dwelling unit or office and all shared community rooms (if applicable).

Additionally, in multifamily buildings provide at least one easily accessible, permanent and dedicated indoor area for the collection and storage of materials for recycling. And in single-family homes, note that points will be accrued only if curbside recycling pickup is available.

Collected materials should include, at a minimum, paper, cardboard, glass, metals and plastics.

#### RATIONALE

Recycling prevents usable materials from entering the waste stream. Providing bins within the living space for the separation of recyclables from trash encourages higher rates of recycling. Similarly, a dedicated indoor space for recycling encourages higher adoption rates.

#### RECOMMENDATIONS

- Check with the community where your project is located to determine recycling ordinances that may exist.
- Ensure that signage and bin colors are consistent across the project, and with local community norms where applicable.
- Designate an area for recyclable collection and storage that is appropriately sized and located in a convenient area.
- In multifamily buildings, instruct occupants on recycling procedures through clear and visible signs that include pictures and that are translated into a variety of languages spoken by residents.
- Include the recycling policies and procedures in the Occupant Manual (Criterion 8.3).



---

## *RESOURCES*

- Iowa Waste Exchange is a no cost, non-regulatory program that provides waste reduction and recycling technical assistance; [www.iowadnr.gov/Environmental-Protection/Land-Quality/Waste-Planning-Recycling/iowa-Waste-Exchange-IWE](http://www.iowadnr.gov/Environmental-Protection/Land-Quality/Waste-Planning-Recycling/iowa-Waste-Exchange-IWE)
- Enterprise Community Partners Resource Center: Enterprise Green Communities hosts a variety of resident engagement tools and trainings, including a module on waste reduction and recycling. [www.enterprisecommunity.org/solutions-and-innovation/green-communities/tools-and-services/resident-engagement](http://www.enterprisecommunity.org/solutions-and-innovation/green-communities/tools-and-services/resident-engagement)

INTRODUCTION CRITERIA  
CHECKLIST

- 1 INTEGRATIVE DESIGN
- 2 LOCATION +  
NEIGHBORHOOD FABRIC
- 3 SITE IMPROVEMENTS
- 4 WATER CONSERVATION
- 5 ENERGY EFFICIENCY
- 6 MATERIALS
- 7 HEALTHY LIVING  
ENVIRONMENT**
- 8 OPERATIONS,  
MAINTENANCE  
+ OCCUPANT  
ENGAGEMENT

APPENDIX

## HEALTHY LIVING ENVIRONMENT

REDUCING CONTAMINANTS  
AND OPTIMIZING VENTILATION  
IMPROVE INDOOR AIR QUALITY  
AND PROJECT DURABILITY,  
AND UNIVERSAL DESIGN  
AND ACTIVE DESIGN  
MEASURES PROMOTE  
PHYSICAL MOBILITY.

## 7.1 VENTILATION

### MANDATORY: NEW CONSTRUCTION AND SUBSTANTIAL REHAB

### OPTIONAL: MODERATE REHAB | 12 POINTS MAXIMUM

#### REQUIREMENTS

##### RESIDENTIAL PROJECTS

For each dwelling unit, in full accordance with ASHRAE 62.2-2013, install:

- A local mechanical exhaust system in each bathroom [4 points if Moderate Rehab]
- A local mechanical exhaust system in each kitchen [4 points if Moderate Rehab]
- A whole-house mechanical ventilation system [4 points if Moderate Rehab]

*Note: Local exhaust airflow may be credited toward the whole-house ventilation airflow requirement when local exhaust fans are used to provide whole-house mechanical ventilation.*

Also, for each multifamily building of four stories or more, in full accordance with ASHRAE 62.1-2013, install:

- A mechanical ventilation system for all hallways and common spaces [3 points if Moderate Rehab]

For all project types, in addition to the above requirements:

- All systems and associated ductwork must be installed per manufacturer's recommendations.
- All individual bathroom fans must be ENERGY STAR-labeled, wired to turn on with the light switch or separate switch, and equipped with a humidistat sensor, timer or other control (e.g., occupancy sensor, delay off switch, ventilation controller).
- If using central ventilation systems with rooftop fans, each rooftop fan must be direct-drive and variable-speed with speed controller mounted near the fan. Fans with design CFM 300-2000 must also have an ECM motor.

*Note: For Substantial and Moderate Rehab projects, particularly those of a historic or landmark nature, consult Appendix A of ASHRAE 62.2-2013 for compliance options for ventilation in existing buildings.*

##### NON-RESIDENTIAL PROJECTS

For non-residential projects comply with ASHRAE 62.1-2013.

#### RATIONALE

Optimal ventilation improves indoor air quality, contributing to a healthier living environment.

Properly sized and controlled exhaust fans in bathrooms and kitchens remove moisture-laden air, lowering the potential for indoor mold growth that may yield odors, pose health hazards to residents and create durability concerns. Kitchen fans also help remove carbon dioxide and carbon monoxide over fuel-burning appliances and other air contaminants that may be byproducts of cooking. And ENERGY STAR-qualified bathroom fans use 65% less energy on average than standard models and move more air per unit of energy used with less noise. Timers and humidistat sensors help to ensure that fans regularly remove moisture and provide adequate ventilation.

## RECOMMENDATIONS

- For climate-specific strategies, consult ASHRAE 62.2-2013 and the Resources below.
- For projects located in humid climates, supplemental dehumidification may be necessary to maintain comfort during times of high ambient relative humidity. Design a system with the capacity to meet ASHRAE requirements, and then provide additional accommodations to adjust the outside air introduced as needed.
- Avoid exceeding ventilation requirements, particularly when using local exhaust. Excessive exhaust may depressurize dwelling units, potentially back-drafting combustion appliances.
- Proper installation of each ventilation system is as critical as its design to its performance. Consult the Resources below for best-practice installation techniques. Test exhaust fan performance at rough-in.
- Placing a single multi-port, in-line fan in each dwelling unit to exhaust air from the kitchen and bathroom(s) is an acceptable ventilation strategy. If utilizing this strategy, in addition to meeting local code requirements for the minimum distance of thru-wall exhaust vents from windows, ensure that the placement of the exhaust grill meets code requirements for kitchen ventilation.
- With continuous, demand-controlled or other centralized ventilation systems, the project team (specifically, the designer, installer and maintenance staff) should ensure that the systems are balanced from unit to unit to meet the requirements of ASHRAE 62.2-2013. Also, consider installing fans with ECM motors for fans designed to exhaust more than 250 CFM.
- Consider the following mechanical controls for introducing outside air:
  - Flow control / butterfly damper to regulate the amount of air introduced through an outside air intake.
  - Shut-off damper (electronic or barometric) to close an outside air intake when the HVAC system is not calling for air.
  - Fan timer /cycler on the HVAC system to regulate the length of time an outside air intake remains open.

## RESOURCES

- Presentation comparing ASHRAE 62.2-2010 and 62.2-2013, [www.oregon.gov/ohcs/CRD/SOS/docs/ASHRAE\\_Power-Point-Presentation.pdf](http://www.oregon.gov/ohcs/CRD/SOS/docs/ASHRAE_Power-Point-Presentation.pdf)
- ASHRAE Standard 62.2: This site provides links to various ASHRAE standard publications: [www.ashrae.org/resources--publications/bookstore/standards-62-1--62-2](http://www.ashrae.org/resources--publications/bookstore/standards-62-1--62-2)
- ASHRAE Standard 62.1 Users Manual provides best practice examples: [www.ashrae.org/resources--publications/bookstore/62-1-users-manual](http://www.ashrae.org/resources--publications/bookstore/62-1-users-manual)
- See ASHRAE's Indoor Air Quality Guide: Best Practices for Design, Construction and Commissioning: [www.ashrae.org/resources--publications/bookstore/indoor-air-quality-guide](http://www.ashrae.org/resources--publications/bookstore/indoor-air-quality-guide)
- "Ventilate Right: Ventilation Guide for New and Existing California Homes": This site provides this thorough, user-friendly guide to the intent of installing ventilation systems in accordance with ASHRAE 62.2 as well as best practices in ventilation system design and installation. Equally applicable to projects outside the state of California. [homes.lbl.gov/ventilate-right](http://homes.lbl.gov/ventilate-right)
- Building America Solution Center: This searchable database includes pictorial guides for best practices in ventilation system design and installation. [basc.pnnl.gov/resource-guides](http://basc.pnnl.gov/resource-guides)
- Building Science Corporation, "Ventilation for New Low-rise Residential Buildings": This helpful guide is available online: [buildingscience.com/documents/special/ventilation-new-low-rise-residential-buildings](http://buildingscience.com/documents/special/ventilation-new-low-rise-residential-buildings)

- ENERGY STAR: This website describes the advantages of ENERGY STAR-labeled ventilation fans and provides product and manufacturer lists. [www.energystar.gov/index.cfm?c=vent\\_fans.pr\\_vent\\_fans](http://www.energystar.gov/index.cfm?c=vent_fans.pr_vent_fans)
- Home Ventilating Institute (HVI), Ventilation Systems and Controls: The HVI provides consumers an assurance of product performance. It also works to increase public awareness of the need for good ventilation and provides resources for selecting the proper ventilation products. [www.hvi.org/](http://www.hvi.org/) and <https://www.hvi.org/publications/index.cfm>
- University of Minnesota, Common Questions about Heat and Energy Recovery Ventilators: This site provides a brief, easy-to-understand overview of heat- and energy-recovery ventilators. [www.extension.umn.edu/distribution/housingandclothing/DK7284.html](http://www.extension.umn.edu/distribution/housingandclothing/DK7284.html)

## 7.2 CLOTHES DRYER EXHAUST

### MANDATORY

#### *REQUIREMENTS*

Clothes dryers must be exhausted directly to the outdoors using rigid-type ductwork, except for condensing dryers, which must be plumbed to a drain.

#### *RATIONALE*

Outdoor venting of clothes dryers substantially reduces air moisture that can lead to mold growth. Outdoor venting also removes odors and allergens from scented detergents and fabric softeners that contain volatile organic compounds (VOCs) from the conditioned space.

#### *RECOMMENDATIONS*

- It is important to minimize the length of the duct run to avoid buildup of moisture and particles that can inhibit the flow of air. Rigid duct materials are preferred to help ensure clean ducts and reduced buildup of particles and moisture.
- Locating the dryer on an exterior wall will allow a minimized duct run for the exhaust.

## 7.3 COMBUSTION EQUIPMENT

### MANDATORY

#### REQUIREMENTS

For new construction and rehab projects, specify power-vented or direct-vent equipment when installing any new combustion appliance for space or water heating that will be located within the conditioned space.

In Substantial and Moderate Rehabs, if there is any combustion equipment located within the conditioned space for space or water heating that is not power-vented or direct-vent and that is not scheduled for replacement, conduct initial combustion safety testing. Conduct the combustion safety testing for central systems and for 10% of these individual dwelling unit systems per RESNET or BPI Combustion Safety Test Procedures. Report any deficiencies immediately to the owner or owner's representative in any failed tested system.

Install one hard-wired carbon monoxide (CO) alarm with battery backup function for each sleeping zone, placed per National Fire Protection Association (NFPA) 720.

Projects without any combustion equipment (i.e., space and water heating equipment, cook tops, dryers or any other combustion equipment) and projects with combustion equipment located only in detached utility buildings or open-air facilities are exempt from this measure.

#### RATIONALE

Direct-vent appliances bring outdoor air through a sealed pipe and help exhaust combustion products directly outdoors through another hard-piped vent. No indoor air is used, so there is very little risk of spillage or back-drafting. Power-vented appliances rely on indoor air, but use a fan to push exhaust products through the flue to the outside. These are much less susceptible to spillage and back-drafting than conventional units.

#### RECOMMENDATIONS

CO and smoke detectors may be hard wired to the heating and domestic hot water (DHW) system, thus activating if that equipment malfunctions.

#### RESOURCES

- U.S. Environmental Protection Agency, Combustion Products and Carbon Monoxide: These two extensive EPA sites describe the sources of carbon monoxide and other combustion gases, their health effects, steps to reduce exposure, and related standards and guidelines, and provide additional resources and links. [www.epa.gov/iaq/combust.html](http://www.epa.gov/iaq/combust.html)
- NFPA 720 contains requirements for the performance, installation, operation, inspection, testing and maintenance of CO detection and warning equipment. These requirements address installations of commercial systems and components as well as installations of single- and multiple-station CO alarms and household CO detection systems. [www.nfpa.org/codes-and-standards/all-codes-and-standards/list-of-codes-and-standards/detail?code=720](http://www.nfpa.org/codes-and-standards/all-codes-and-standards/list-of-codes-and-standards/detail?code=720)
- Underwriters Laboratories, Carbon Monoxide Alarm Considerations for Code Authorities: [www.ul.com/wp-content/uploads/2014/04/ul\\_CarbonMonoxideAlarms.pdf](http://www.ul.com/wp-content/uploads/2014/04/ul_CarbonMonoxideAlarms.pdf)
- U.S. Consumer Product Safety Commission: "Carbon Monoxide Questions and Answers": [www.cpsc.gov/Safety-Education/Safety-Education-Centers/Carbon-Monoxide-Information-Center/Carbon-Monoxide-Questions-and-Answers](http://www.cpsc.gov/Safety-Education/Safety-Education-Centers/Carbon-Monoxide-Information-Center/Carbon-Monoxide-Questions-and-Answers)
- Building Performance Institute, Combustion Safety Procedures: This site provides a set of guidelines regarding combustion safety when conducting audits and diagnostic testing. [www.bpi.org/reference-sheets-and-technical-documents](http://www.bpi.org/reference-sheets-and-technical-documents)

## 7.4 ELIMINATION OF COMBUSTION WITHIN THE CONDITIONED SPACE

**OPTIONAL | 9 OR 11 POINTS**

### REQUIREMENTS

#### OPTION 1

No combustion equipment used for cooking (to include, but not limited to, ranges, cooktops, stoves, ovens) as part of the building project. *[9 points]*

OR

#### OPTION 2

No combustion equipment used as part of the building project. *[11 points]*

### RATIONALE

The process of combustion releases pollutants. Natural gas cooking burners have been shown to emit substantial quantities of pollutants. Eliminating combustion equipment from a building project eliminates the possibility of negative resident and staff health impacts due to exposure to combustion byproducts.

### RECOMMENDATIONS

Higher-performance building envelopes with very small heating and cooling loads may be satisfied with high-efficiency electric heat.

### RESOURCES

- “Pollutant Exposures from Natural Gas Cooking Burners: A Simulation-Based Assessment for Southern California.” Jennifer M. Logue, Neil E. Klepeis, Agnes B. Lobscheid, Brett Singer: Residential natural gas cooking burners (NGCBs) can emit substantial quantities of pollutants, and they are typically used without venting range hoods. [ehp.niehs.nih.gov/1306673](http://ehp.niehs.nih.gov/1306673)
- “Take Care in the Kitchen: Avoiding Cooking-Related Pollutants.” Nate Seltenrich: [ehp.niehs.nih.gov/122-a154/](http://ehp.niehs.nih.gov/122-a154/) or Environmental Health Perspectives 122:A154–A159: [dx.doi.org/10.1289/ehp.122-A154](https://doi.org/10.1289/ehp.122-A154)

## 7.5 VAPOR RETARDER STRATEGIES FOR ALL NEW CONSTRUCTION PROJECTS AND REHAB PROJECTS WITH FOUNDATION WORK IN SCOPE MANDATORY

### REQUIREMENTS

#### **Beneath Concrete Slabs** (including those in basements and crawl spaces)

- Install a capillary break as follows: 4-inch layer of ½-inch diameter or greater clean aggregate  
**OR**  
Install a 4-inch uniform layer of sand, overlain with a layer or strips of geotextile drainage matting installed according to the manufacturer's instructions
- Immediately above the capillary break, install at least 10-mil polyethylene sheeting overlapped at least 6 inches at the seams to serve as a vapor retarder in direct contact with the slab above.
- Install at least 1" (R-5) extruded ≥25 lb high-density polystyrene below the entire slab (2" (R-10) of foam under at least the outer four feet of the slab perimeter) in addition to the vapor barrier to control mold growth.
- Place a capillary break on top of footings between the footing and foundation wall to stop capillary action.
- On interior below-grade walls, do not use a vapor barrier over air-permeable insulation. Do not install a below-grade vertical insulation (such as polyethylene sheeting, vinyl wallpaper, vinyl(plastic)-faced blankets, or foil faced), which can trap moisture inside wall systems. Semi-vapor permeable rigid insulation is not considered a vapor barrier.

#### **Beneath Crawl Spaces**

- Install at least 10-mil cross-laminated polyethylene on the crawl floor, extended up at least 12 inches on piers and foundation walls, and with joints overlapping at least 12 inches. The 10-mil and the cross-lamination ensure longevity of the poly.
- Line the likely "high-traffic" areas of the crawl space with foam board, so the polyethylene beneath will not be disturbed.

### RATIONALE

Water can migrate through concrete and most other masonry materials. Proper foundation drainage prevents water from saturated soils from being pushed by hydrostatic pressure through small cracks. Vapor retarders and waterproofing materials can greatly reduce the migration of moisture that can occur even in non-saturated soils.

### RECOMMENDATIONS

- Where a high-water table is anticipated or observed or has been documented in the soil boring report, or where specifically recommended by the geotechnical engineer, provide subsurface drain tile or other drainage system in strict accordance with the geotechnical engineer's or other qualified professional's recommendations to divert underground water away from the structure.
- Ensure that subsequent trades' work does not puncture the vapor retarder.

## RESOURCES

- Advanced Energy: Comprehensive design and installation guidelines. [www.crawlspace.org](http://www.crawlspace.org)
- Building Science Corporation: Features articles on conditioned crawl spaces. Select the crawlspace, foundations and slabs, or high R-value walls topics at [buildingscience.com/document-search](http://buildingscience.com/document-search)
- U.S. Department of Energy, Office of Energy Efficiency & Renewable Energy, Building America: Free downloads on best building practices. [energy.gov/eere/buildings/building-america-bringing-building-innovations-market](http://energy.gov/eere/buildings/building-america-bringing-building-innovations-market)



Slab Insulation



Capillary Break

## 7.6 WATER DRAINAGE

**FOR ALL NEW CONSTRUCTION PROJECTS AND THOSE REHAB PROJECTS THAT INCLUDE REPLACING PARTICULAR ASSEMBLIES CALLED OUT BELOW MANDATORY**

### REQUIREMENTS

Provide water drainage away from walls, windows and roofs by implementing the following techniques:

#### Water Management: Wall Systems

- Provide a continuous housewrap /weather-resistive barrier with sheets lapped shingle-style to prevent bulk water that penetrates the finished exterior cladding system from entering the wall assembly or being introduced through window or door openings or through other penetrations. Alternatively, install a fluid applied weather-resistive barrier in accordance with manufacturer's instructions.
- Flashings at roof /wall intersections and wall penetrations (i.e., plumbing, electrical, vents, HVAC refrigerant lines and the like in addition to windows and doors) must be integrated with the weather-resistive barrier and drainage plane to prevent bulk water from entering the exterior wall assembly.
- Provide a pathway for bulk water that may be behind the exterior cladding system to safely exit the exterior wall assembly. For example, a drainage plane and weep holes for brick-clad structures.



Water Management - Walls



Water Management - Foundations

### Water Management: Roof Systems

- Install drip edge at entire perimeter of roof.
- At wall /roof intersections, maintain 2” clearance between wall cladding and roofing materials, install flashing along the intersection, and use kick-out flashing.



Water Management - Roofs



Flashing Integrated into Drainage Plane

## RATIONALE

Diverting water from the project prevents bulk water entry into wall systems, which can contribute to moisture-related problems such as mold and the deterioration of wood and other building materials. Properly installed weather barriers, including flashing and drainage planes, help direct water away from wall cavities.

## RECOMMENDATIONS

Ensure that a vapor retarder with an appropriate permeability rating is installed on the correct side of the wall assembly, based on climate considerations and drying potential.

## RESOURCES

- Building Science Corporation, water management resources. [buildingscience.com/documents/reports/rr-0103-water-management/view](https://buildingscience.com/documents/reports/rr-0103-water-management/view)
- U.S. Department of Energy, Building America Solution Center: Free downloads on best building practices. [energy.gov/eere/buildings/building-america-solution-center](https://energy.gov/eere/buildings/building-america-solution-center)
- U.S. Environmental Protection Agency, Indoor airPLUS Construction Specifications: Includes detailed construction specifications, several of which are focused on moisture management. [www.epa.gov/indoorairplus/indoor-airplus-program-documents](https://www.epa.gov/indoorairplus/indoor-airplus-program-documents)
- The Water Management Guide by Joseph W. Lstiburek provides excellent installation details for weather-resistive barriers and flashing. [buildingscience.com/bookstore/ebook/ebook-water-management-guide](https://buildingscience.com/bookstore/ebook/ebook-water-management-guide)

## 7.7 MOLD PREVENTION: WATER HEATERS

### MANDATORY

#### *REQUIREMENTS*

Provide adequate drainage for water heaters that includes drains or catch pans with drains piped to the exterior of the dwelling.

Water heaters should be located in rooms with non-water-sensitive floor coverings. Drain pans should be sloped and corrosion-resistant (e.g., stainless or plastic) with drains at the low point. Condensate lines should be drained to a drainage system, and not just deposited under slab.

Note: Tankless water heaters do not require drains or catch pans with drains piped to the exterior of the building.

#### *RATIONALE*

The use of heaters with drains and catch pans prevents moisture problems caused by leakage or overflow. This prevents water from sitting idle, creating excess moisture and allowing mold to germinate.

#### *RECOMMENDATIONS*

- Buildings with one or more central water heaters should comply with ASHRAE Standard 188P to assess and manage the risks associated with Legionella in building water systems. Private water supplies should be tested to ensure that water does not have biological or chemical contaminants.
- If local code does not permit draining to the exterior of the project, water heaters can be drained directly to the sewer line.

#### *RESOURCES*

- American Society of Heating, Refrigerating and Air-Conditioning Engineers, Inc., Standard 62.1 User's Manual. [www.ashrae.org/resources--publications/bookstore/62-1-users-manual](http://www.ashrae.org/resources--publications/bookstore/62-1-users-manual)
- International Code Council, "Mold: Tips on Prevention and Control." [www.iccsafe.org/BSM/Documents/PR/Mold\\_Brochure-lores.pdf](http://www.iccsafe.org/BSM/Documents/PR/Mold_Brochure-lores.pdf)
- Canada Mortgage and Housing Corporation's "Fighting Mold": For information on mold identification and remediation in existing homes. [www.building-insights.com/ModuleFile/Fighting+Mold+-+The+Homeowners+Guide+\(CMHC\).pdf?id=10](http://www.building-insights.com/ModuleFile/Fighting+Mold+-+The+Homeowners+Guide+(CMHC).pdf?id=10)

## 7.8 RADON MITIGATION

### *New Construction and Substantial Rehab*

#### MANDATORY

#### REQUIREMENTS

##### **New Construction**

Install passive radon-resistant features below the slab. Also install a vertical vent pipe with junction box within 10 feet of an electrical outlet in case an active system should prove necessary in the future.

##### **Substantial Rehab**

Substantial Rehab projects should be tested under the supervision of a radon professional for the presence of radon in accordance with the American Association of Radon Scientists and Technologists' Protocol for Conducting Radon and Radon Decay Product Measurements in Multifamily Buildings (ANSI-AARST MAMF-2012). In time-sensitive situations, consistent with HUD's radon policy, a radon professional may sample a minimum of 25% of randomly selected ground-level dwelling units.

If the radon level is above the EPA action level of 4 pCi /L (pico curies per liter), install radon- reduction measures per ANSI-AARST Provisional Standard: Radon Mitigation Standards for Multifamily Buildings ANSI/AARSTR RMS-MF (PS) 2013 or ASTM E 2121-11: Standard Practice for Installing Radon Mitigation Systems in Existing Low-Rise Residential Buildings.

A radon professional shall have:

- Certification from either the American Association of Radon Scientists and Technologists' (AARST) National Radon Proficiency Program (NRPP) or the National Radon Safety Board (NRSB), and
- Certification from the Iowa Department of Public Health, [idph.iowa.gov/radon/get-certified](http://idph.iowa.gov/radon/get-certified).

#### RATIONALE

Radon is the leading environmental cause of cancer mortality in the United States. Exposure to radon is the second leading cause of lung cancer in the U.S., after smoking. A smoker who is also exposed to radon has a much higher risk of lung cancer. The only way to know if homes have elevated radon levels is to test. Testing is easy and inexpensive, and elevated radon levels can be reliably mitigated, if necessary, with simple, durable and commonly available materials and techniques.

#### RECOMMENDATIONS

- For residential projects, use of the following standard is recommended: ANSI-AARST Standard: Reducing Radon in New Construction: 1 & 2 Family Dwellings and Townhouses, CCAH-2013. For non-residential projects, follow the guidance in Radon Prevention in the Design and construction of Schools and other Large Buildings.
- Consult Iowa's state radon program for current information about radon in your area. [idph.iowa.gov/radon](http://idph.iowa.gov/radon)
- EPA recommends that all homes built with radon-resistant features in EPA Radon Zone 1 pre-emptively include a radon vent fan. All of Iowa is in EPA Radon Zone 1. A radon vent fan should be installed when the test result is 4 pCi/L or more.

- Guidance for underground garages:
  - International Mechanical Code (IMC), which requires 0.75 cfm/sf for garages serving multifamily projects, and ASHRAE Standard 62.1-2013 section 5.15, which encourages maintaining attached garage air pressure at or below adjacent occupiable spaces.
  - If the pressure management strategy is not designed to continually maintain negative pressure in the underground garage space relative to the occupied spaces (i.e., if a timer is used for exhaust fan control), then radon control is not assured. In such situations, use either the radon-resistant New Construction techniques summarized in IAP spec 2.1 ([www.epa.gov/indoorairplus/pdfs/construction\\_specifications.pdf](http://www.epa.gov/indoorairplus/pdfs/construction_specifications.pdf)) and detailed further in EPA guidance and/or test the occupied space for radon.
  - If the underground garage does not cover the entire foundation (i.e., some living space is directly above a slab or crawlspace), then those portions of the project should be handled per Indoor airPLUS specs.
  - Any mechanical or service closets in the garage area that are connected to the conditioned enclosure should be aggressively sealed between the garage and the conditioned space.
- For projects located on brownfields or proximate to industrial operations that are not in EPA Zone 1, consider testing for radon to determine if elevated levels exist on-site. If the radon level is elevated above 4 pCi/L (pico curies per liter), install radon-reduction measures.

## RESOURCES

- Iowa Department of Public Health Radon Program. [www.idph.iowa.gov/radon](http://www.idph.iowa.gov/radon)
- U.S. Environmental Protection Agency, “Protocols for Radon and Radon Decay Product Measurements in Homes.” [www.epa.gov/radon/pdfs/homes\\_protocols.pdf](http://www.epa.gov/radon/pdfs/homes_protocols.pdf)
- National Center for Healthy Housing, [nchh.org/Portals/0/Contents/Factsheet\\_Radon--no%20HDF.pdf](http://nchh.org/Portals/0/Contents/Factsheet_Radon--no%20HDF.pdf)
- U.S. Environmental Protection Agency, “Building Radon Out.” 2006 (#EPA/402-K-01-002). [www.epa.gov/sites/production/files/2014-08/documents/buildradonout.pdf](http://www.epa.gov/sites/production/files/2014-08/documents/buildradonout.pdf)
- Washington State, Extension Energy Program, “Builder’s Field Guide”: Chapter 2 of this field guide provides tips, procedures and schematics for understanding how to mitigate radon risks during new construction. [www.energy.wsu.edu/Documents/Builders\\_Field\\_Guide-2006.pdf](http://www.energy.wsu.edu/Documents/Builders_Field_Guide-2006.pdf)
- ASTM E 2121-11 Standard Practice for Installing Radon Mitigation Systems in Existing Low-Rise Residential Buildings. [www.astm.org/Standards/E2121.htm](http://www.astm.org/Standards/E2121.htm)
- ASTM E 1465-08a Standard Practice for Radon Control Options for the Design and Construction of New Low-Rise Residential Buildings. [www.astm.org/Standards/E1465.htm](http://www.astm.org/Standards/E1465.htm)
- ANSI-AARST Provisional Standard: Radon Mitigation Standards for Multifamily Buildings ANSI/AARSTR RMS-MF (PS) 2014. [aarst-nrpp.com/wp/store/multifamily-building-mitigation-rms-mf-2014](http://aarst-nrpp.com/wp/store/multifamily-building-mitigation-rms-mf-2014)
- ANSI-AARST Standard: Reducing Radon in New Construction: 1&2 Family Dwellings and Townhouses, CCAH-2013. [aarst-nrpp.com/wp/store/rnc-for-homes-ccah-2012](http://aarst-nrpp.com/wp/store/rnc-for-homes-ccah-2012)
- ANSI-AARST Standard: Protocols for Conducting Radon and Radon Decay Product Measurements in Multifamily Buildings, MAMF 2012. [aarst-nrpp.com/wp/store/multifamily-building-measurement-mamf-2017](http://aarst-nrpp.com/wp/store/multifamily-building-measurement-mamf-2017)
- AARST Standard: Protocols for Radon Measurements in Homes, MAH September 2005. [aarst-nrpp.com/wp/store/residential-home-measurement-mah-2014](http://aarst-nrpp.com/wp/store/residential-home-measurement-mah-2014)

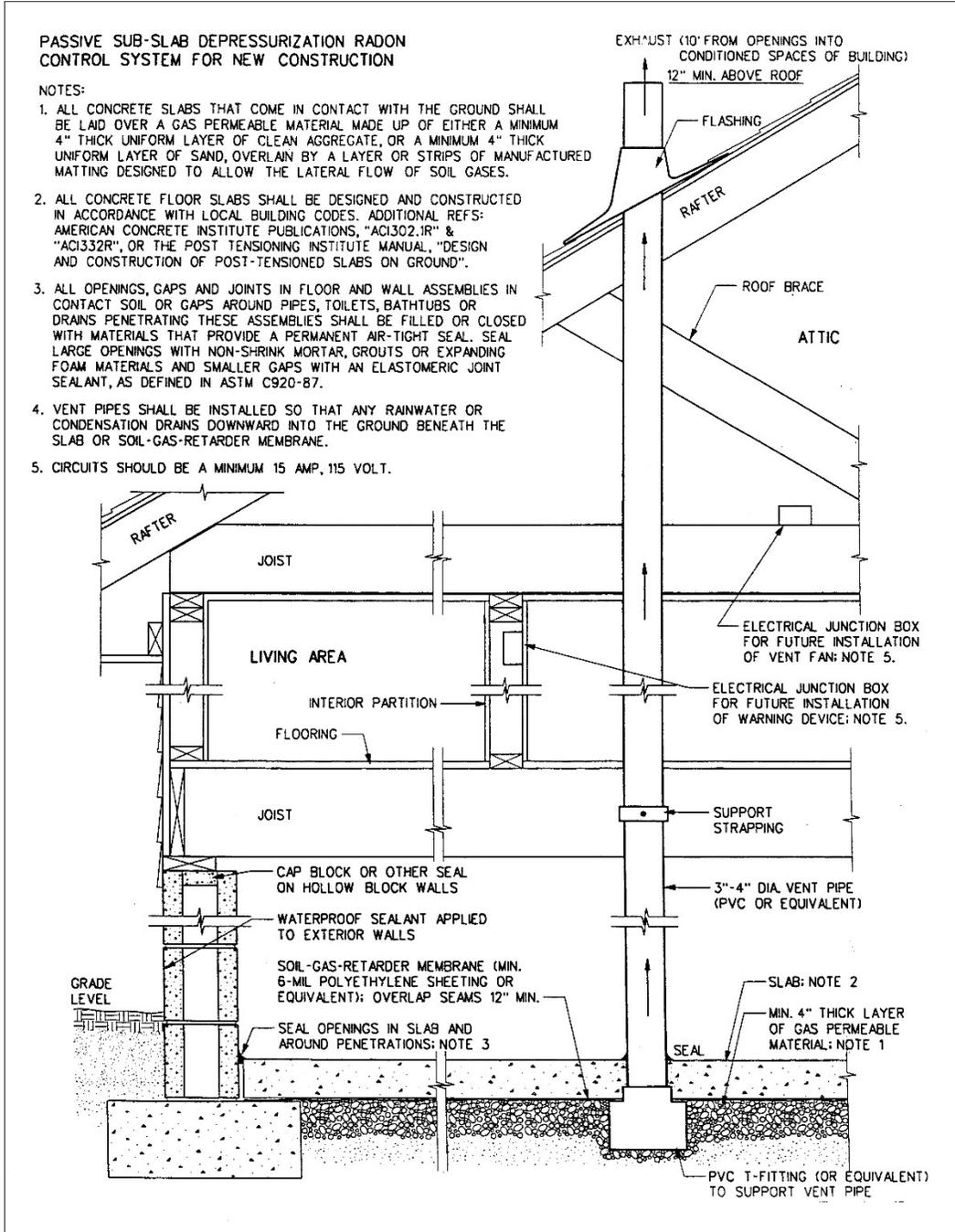

Passive Sub-Slab Radon Control System

## 7.9 GARAGE ISOLATION

### MANDATORY

#### *REQUIREMENTS*

For projects with an attached garage, the following requirements apply.

- Provide a continuous air barrier between the conditioned space and any garage space to prevent the migration of contaminants into the living space. Visually inspect common walls and ceilings between attached garages and living spaces to ensure that they are air-sealed before insulation is installed.
- Do not install ductwork or air handling equipment in a garage.
- Fix all connecting doors between conditioned space and garage with an automatic closer. All connecting doors shall be fire rated and fixed with gaskets, or otherwise made substantially airtight with weather stripping. All access hatches shall be fire rated.
- Install one hard-wired carbon monoxide (CO) alarm with battery backup function for each sleeping zone of the project, placed per National Fire Protection Association (NFPA) 720.

#### *RATIONALE*

Carbon monoxide inhalation can be dangerous to human health. The air barrier and air sealing will help prevent carbon monoxide migration from the garage to the living space, and the CO alarm will help ensure that residents are alerted in the case of accidental accumulation of the gas.

#### *RECOMMENDATIONS*

Refer to ASHRAE 62.2 for garage contaminant isolation measures.

#### *RESOURCES*

- National Institute of Standards and Technology, “Air and Pollutant Transport from Attached Garages to Residential Living Spaces.” This report provides an overview of the major issues, as well as a review of relevant scientific studies and a series of field studies. [www.fire.nist.gov/bfrlpubs/build03/art068.html](http://www.fire.nist.gov/bfrlpubs/build03/art068.html)
- The Energy & Environmental Building Alliance, “Builder’s Guide” series for specific North American climate zones: Cold Climates, Mixed-Humid Climates, Hot-Humid Climates, and Hot-Dry & Mixed-Dry Climates, by Joseph Lstiburek, Ph.D., P.Eng. Building Science Press: Refer to the discussion and construction details regarding air sealing and connected garages. [www.eeba.org/bookstore/cat-Builders\\_Guides-4.aspx](http://www.eeba.org/bookstore/cat-Builders_Guides-4.aspx)
- EPA Indoor airPLUS Construction Specifications. [www.epa.gov/sites/production/files/2015-10/documents/construction\\_specification\\_rev\\_3\\_508.pdf](http://www.epa.gov/sites/production/files/2015-10/documents/construction_specification_rev_3_508.pdf)

## 7.10 INTEGRATED PEST MANAGEMENT

### MANDATORY

#### *REQUIREMENTS*

Design for easy inspection of all pest-prone areas (interior and exterior), and engineer slabs and foundations to minimize pest entry.

Seal all wall, floor and joint penetrations with low-VOC caulking or other appropriate nontoxic sealing methods (window screens, door sweeps, escutcheon plates, elastomeric sealants) to prevent pest entry. Use rodent- and corrosion-proof screens (e.g., copper or stainless-steel mesh or rigid metal cloth) for openings greater than ¼-inch. Also pay close attention to sealing off entry points under kitchen and bathroom sinks. During all future repair work by building staff, utilities and contractors should reseal these areas once repair or installation work is completed.

#### *RATIONALE*

Incorporating pest prevention in the design of new buildings and in retrofits for existing buildings increases the durability of the building and, in the end, saves time and money by proactively taking steps to prevent conditions that attract pests. Sealing of cracks and penetrations will minimize entry points for pests such as rodents and cockroaches. Exposure to allergens from pests is linked with asthma and respiratory issues. Rodents may also carry diseases. Avoiding unnecessary pesticides, improving housekeeping, and promptly responding to pest problems and conditions that contribute to pests will reduce the chemicals needed to treat pests and will keep buildings pest-free longer than a routine chemical treatment program.

#### *RECOMMENDATIONS*

- Refer to Maintenance and Resident Manuals (Criteria 8.1 and 8.3) for complementary practices.
- Plan exterior surfaces, lighting, drainage and landscaping to minimize the attractiveness of the site to pests.
- Preventative pest management work should be completed in conjunction with air sealing. Project teams should work with an air sealing contractor and a pest management professional to ensure that IPM strategies are part of the scope.
- Rehabilitation of an existing building provides the opportunity to address physical barriers that make handling garbage difficult. Engage with residents and building maintenance staff to identify and correct problems with the collection and storage of waste (e.g., inadequate space in trash rooms, narrow stairs, improper signage, unsafe access to exterior trash receptacles, etc.).

## RESOURCES

- “Pest Prevention by Design: Authoritative Guidelines for Building Pests Out of Structures,” San Francisco Department of the Environment.  
[www.sfenvironment.org/download/pest-prevention-by-design-guidelines](http://www.sfenvironment.org/download/pest-prevention-by-design-guidelines)
- “How to Control Pests Safely: Getting Rid of Cockroaches and Mice,” New York City Department of Health and Mental Hygiene,  
[www1.nyc.gov/assets/doh/downloads/pdf/pest/pest-bro-healthy-home.pdf](http://www1.nyc.gov/assets/doh/downloads/pdf/pest/pest-bro-healthy-home.pdf)
- The National Center for Healthy Housing, Integrated Pest Management in Affordable Housing: This webpage has resources dedicated to IPM in affordable housing, including model RFPs and contract language for greener pest control, case studies and training.  
[www.nchh.org/Program/HealthyHomesTrainingCenter/IntegratedPestManagement.aspx](http://www.nchh.org/Program/HealthyHomesTrainingCenter/IntegratedPestManagement.aspx)
- “Integrated Pest Management: A Guide for Affordable Housing.” [www.stoppests.org/Guide](http://www.stoppests.org/Guide)
- “Pest Prevention Opportunities During Renovation Work” factsheet, New York City Department of Health and Mental Hygiene, Healthy Homes Program, 2014.  
[www1.nyc.gov/assets/doh/downloads/pdf/pest/pestcontrol-during-renovation.pdf](http://www1.nyc.gov/assets/doh/downloads/pdf/pest/pestcontrol-during-renovation.pdf)
- Model Integrated Pest Management RFP.  
[www.enterprisecommunity.org/download?fid=2025&nid=14015](http://www.enterprisecommunity.org/download?fid=2025&nid=14015)

## 7.11A BEYOND ADA: UNIVERSAL DESIGN — NEW CONSTRUCTION OPTIONAL | 9 POINTS

### REQUIREMENTS

Design a minimum of 15% of the dwelling units (no fewer than one) in accordance with ICC /ANSI A117.1, Type A, Fully Accessible guidelines. Design the remainder of the ground-floor units and elevator-reachable units in accordance with ICC /ANSI A117.1, Type B.

### RATIONALE

Universal Design has been defined as “the design of products and environments to be usable by all people, to the greatest extent possible, without the need for adaptation or specialized design [The Center for Universal Design (1997)].” As applied to residential projects, the principles of Universal Design anticipate and plan for a greater diversity of residents’ abilities and needs, both today and in the future, thereby supporting and facilitating both safety and independence for all residents, including older adults, children and individuals with mobility, visual, cognitive or other impairments.

#### What do we mean by “Beyond ADA”?

As a framework for design, Universal Design is distinct from the goals of accessible or “barrier-free” design. More important, it is also distinct from legally mandated accessibility requirements. Local and federal accessibility laws and regulations provide a base for Universal Design, but define only a minimum level of performance to serve people with disabilities. Furthermore, these laws focus overwhelmingly on requirements for wheelchair users, largely overlooking the broader spectrum of physical, sensory and cognitive disabilities that are far more representative of demographic realities in the United States today.

In referencing “Beyond ADA,” we mean to encourage broader thinking beyond the legally mandated accessibility requirements.

## RECOMMENDATIONS

- Universal Design features should be considered during the integrative design process and for a maximum percentage of units, if not 100%.
- Make streets and paths universally accessible.
- Create paths that are smooth and sufficiently wide, and that have curb cuts — at street crossings and entry points — and turning radii adequate for a wheelchair or walker.
- Create paths with auditory crossing signals, adequate crossing times, clear signage, visible access ramps, median refuge islands, and connections to walking, cycling and public transit routes.
- Support physical activity among children with disabilities by making parks and playground features accessible for both children and their caregivers.

## RESOURCES

- For more information about the ICC /ANSI A117.1 standard:  
[codes.iccsafe.org/public/document/toc/559](https://codes.iccsafe.org/public/document/toc/559)
- The Center for Universal Design (1997). The Principles of Universal Design, Version 2.0. Raleigh, N.C.: North Carolina State University. [www.ncsu.edu/ncsu/design/cud/index.htm](http://www.ncsu.edu/ncsu/design/cud/index.htm)
- 2012 Enterprise Green Communities Single and Multifamily Universal Design Specifications. [www.enterprisecommunity.org/solutions-and-innovation/green-communities/tools-and-services/construction-specifications](http://www.enterprisecommunity.org/solutions-and-innovation/green-communities/tools-and-services/construction-specifications)
- Mayor's Office for People with Disabilities, New York City Inclusive Design Guidelines. [www.nyc.gov/html/mopd/html/home/home.shtml](http://www.nyc.gov/html/mopd/html/home/home.shtml)

## 7.11B BEYOND ADA: UNIVERSAL DESIGN — SUBSTANTIAL AND MODERATE REHAB OPTIONAL | 7 OR 9 POINTS

### REQUIREMENTS

Design a minimum of 10% of the dwelling units (one, at minimum) in accordance with ICC /ANSI A117.1, Type A, Fully Accessible guidelines. [7 points]

For an additional 2 points: Design the remainder of the ground-floor units and elevator-reachable units with accessible unit entrances designed to accommodate people who use wheelchairs.

### RATIONALE

See Rationale for Criterion 7.11a: Beyond ADA: Universal Design — New Construction.

### RECOMMENDATIONS

See Recommendations for Criterion 7.11a: Beyond ADA: Universal Design — New Construction.

### RESOURCES

See Resources for Criterion 7.11a: Beyond ADA: Universal Design — New Construction.

## 7.12 ACTIVE DESIGN: PROMOTING PHYSICAL ACTIVITY WITHIN THE BUILDING MANDATORY

### REQUIREMENTS

#### OPTION 1: Stairs

Provide at least one building stairway for everyday travel between floors, whether in the form of a grand staircase or fire stairs. Provide access to and from all floors via the staircase. Place point-of- decision signage at building entrance and corridor intersections to promote stair use for health and other benefits. Ensure that stairway lighting is consistent with, or better than, building corridor lighting to encourage use.

OR

#### OPTION 2: Pathways

For buildings without stairs, or in an instance when using stairs may be hazardous, incorporate at least one strategy inside the building designed to increase frequency and duration of physical activity. Elements such as natural light along pathways, designated resting areas (seating), grab bars, informational displays about walking paths within the building, incremental distance markers, and/or thoughtfully placed exercise equipment in visible and easily accessible shared areas can improve the duration and frequency of physical activity. Include a narrative describing your selection process and how your selected strategy will increase frequency and duration of physical activity.

### RATIONALE

Physical inactivity increases the risk of many chronic diseases and conditions, including obesity, hypertension, heart disease, stroke, some cancers and Type 2 diabetes. Two minutes of stair climbing daily burns enough calories to prevent annual average weight gain. Common stairs also encourage social interactions and improve mental health. Climbing 20–34 floors of stairs per week (~3–5 floors per day) is associated with a reduced stroke risk of 29%, and climbing 100–150 floors of stairs per week is associated with a 10–20% decrease in all-cause mortality.

For those building users for whom stairway travel may be dangerous due to their limited functional mobility, other key design considerations may positively influence their level of physical activity. In these instances, building design measures that increase either frequency or duration of physical activity are encouraged.

### RECOMMENDATIONS

- Consider bi-level lighting that increases lighting once residents access the stairs and reduces lighting to minimum code levels when not in use. This also provides energy benefits.
- Stairwell finish should provide a pleasant experience to encourage stair use by able-bodied people.
- Focus on stairs rather than elevators as the principal means of vertical travel for those who are able to climb the stairs.
- In high-rise buildings, provide an integrated vertical circulation system that incorporates stair use for travel between adjacent floors, so that elevators are used primarily for vertical travel of four floors or more.
- Consider programming elevators so they do not return to the ground floor and do not rest in the open position when not in use.

## RESOURCES

- City of New York. Active Design Guidelines, 2010. [centerforactivedesign.org/guidelines](http://centerforactivedesign.org/guidelines)
- New York City Stair Prompt. [centerforactivedesign.org/stairprompt](http://centerforactivedesign.org/stairprompt)
- Robert Wood Johnson Foundation, Active Living Research. [centerforactivedesign.org/affordablehousingcosts](http://centerforactivedesign.org/affordablehousingcosts)
- Centers for Disease Control and Prevention, Healthier Worksite Initiative: Motivational Signs. [www.cdc.gov/physicalactivity/worksite-pa/toolkits/stairwell/motivational\\_signs.htm](http://www.cdc.gov/physicalactivity/worksite-pa/toolkits/stairwell/motivational_signs.htm)
- Task Force on Community Preventive Services. The Community Guide — What Works to Promote Health. [www.thecommunityguide.org/findings/physical-activity-point-decision-prompts-encourage-use-stairs](http://www.thecommunityguide.org/findings/physical-activity-point-decision-prompts-encourage-use-stairs)
- NYC Department of Health and Mental Hygiene. Active Design Supplement: Affordable Designs for Affordable Housing, 2013. [centerforactivedesign.org/affordablehousingcosts](http://centerforactivedesign.org/affordablehousingcosts)

## 7.13 ACTIVE DESIGN: STAIRCASES AND BUILDING CIRCULATION

### APPLICABLE FOR PROJECTS WITH STAIRS

### OPTIONAL / 10 POINTS

#### REQUIREMENTS

A staircase must be accessible and visible from the main lobby as well as visible within a 25-foot walking distance from any edge of the lobby. Ensure that no turns or obstacles prevent visibility of or accessibility to the qualifying staircase from the lobby, and that the staircase is encountered before or at the same time as the elevators.

From the corridor, accessible staircases should be made visible by:

- Providing transparent glazing of at least 10 square feet (1 square meter) at all stair doors or at a side light
- OR**
- Providing magnetic door holds on all doors leading to the stairs
- OR**
- Removing door enclosures/ vestibules

#### RATIONALE

See rationale for criterion 7.12.

#### RECOMMENDATIONS

- Provide daylighting at each floor/roof level of the stair(s) using windows and/or skylights of at least 8 square feet (1 square meter) in size.
- Incorporate permanent artwork, murals and/or music into the stair environment.
- Incorporate natural ventilation into the stair environment.
- Highlight interesting views, such as prospects onto nature or outdoor gathering areas.
- Integrate the stair with the principal areas of orientation and travel within the building.

#### RESOURCES

- See resources for criterion 7.12

## 7.14 INTERIOR AND OUTDOOR ACTIVITY SPACES FOR CHILDREN AND ADULTS

### *OPTIONAL / 9 POINTS*

#### *REQUIREMENTS*

Provide an on-site dedicated recreation space with exercise or play opportunities for adults and/or children that is open and accessible to all building users. The space must be at least 400 square feet (37 square meters), include adult exercise and/or children's play equipment for a minimum of 5–10% of building users, and ensure minimum operational hours for use of 10 hours/day at least 3 days / week. Complementary building occupant engagement strategies may promote outdoor play, exercise, gardening or other physical activity.

#### *RATIONALE*

Physical inactivity increases the risk of many chronic diseases and conditions, including obesity, hypertension, heart disease, stroke, some cancers and Type 2 diabetes. Child play and adult exercise reduce the risks of obesity, improve mental health and encourage social interactions. Improving access to places for physical activity can result in a 25% increase in the number of people who exercise at least 3 times per week.

#### *RECOMMENDATIONS*

- Provide a physical activity room with exercise equipment and indoor activity spaces for use by building users; post and maintain consistent hours of operation. Open this facility at convenient times (before / after traditional work hours), at least 10 hours per day.
- Locate children's active play areas adjacent to adult exercise spaces, allowing parents to exercise and simultaneously watch over their children at play.
- Design a courtyard, garden, terrace or roof that can serve as outdoor space for children's play and / or adult activities. When designing outdoor spaces, include permanent ground markings to indicate dedicated areas for sports, children's play and adult exercise, and to promote increased active play/exercise.
- Provide a designated outdoor physical activity space for adults.
- In the design of parks and playgrounds, create a variety of climate environments to facilitate activity in different seasons and weather conditions. Provide shaded areas as well as areas that are open to sunlight.
- Locate physical activity spaces in a centrally visible location in the building to help increase awareness and use of these spaces, as well as a sense of safety and security.
- Provide lights on sidewalks and active play areas to extend opportunities for physical activity into the evening.
- Provide views to the outdoors from physical activity/play rooms.

#### *RESOURCES*

- See resources for criterion 7.12

## 7.15 SMOKE-FREE BUILDING

### OPTIONAL | 10 POINTS

#### REQUIREMENTS

Implement and enforce a no-smoking policy in all common and individual living areas, and within a 25-foot perimeter around the exterior of all residential projects. Lease language must prohibit smoking in these locations and specify that it is a violation of the lease to smoke. The no-smoking restriction applies to all owners, tenants, guests and service people. The use of e-cigarettes is prohibited wherever smoking is prohibited.

#### RATIONALE

Secondhand smoke is the third leading cause of preventable death in this country. Air filtration and ventilation systems do not eliminate the health hazards caused by secondhand smoke. Smoke from one unit may seep through the cracks, be circulated by a shared ventilation system or otherwise enter the living space of another. In addition to the negative health effects, smoking significantly increases fire hazards and increases cleaning and maintenance costs.

#### RECOMMENDATIONS

- A designated outdoor smoking area should be provided as an alternative arrangement for those who smoke or vape. Design this area to be as attractive as possible, and provide shelter from the elements in order to encourage smokers to smoke in this location rather than inside the building or within the 25-foot-perimeter no-smoking buffer area.
- Provide suitable receptacles in the designated outdoor smoking area for the disposal of cigarette butt litter. Ensure that the receptacles are inside the project line.

#### RESOURCES

- Iowa Department of Public Health provides Smokefree Air Act resources: [smokefreeair.iowa.gov](http://smokefreeair.iowa.gov)
- National Center for Healthy Housing, “Reasons to Explore Smoke-Free Housing Fact Sheet.” [www.nchh.org/Portals/0/Contents/NCHH\\_Green\\_Factsheet\\_Smokefree.pdf](http://www.nchh.org/Portals/0/Contents/NCHH_Green_Factsheet_Smokefree.pdf)
- American Lung Association, Air Quality in the Home: This site includes an entire section devoted to indoor air quality in the home. Choose “Air Quality” at the bottom of the screen and then click “Indoor Air Quality” and “Air Quality in the Home” to find numerous articles and educational pieces about maintaining a healthy indoor environment. [www.lung.org/our-initiatives/healthy-air/indoor](http://www.lung.org/our-initiatives/healthy-air/indoor)
- U.S. Environmental Protection Agency, Indoor Air Quality Division: This site has numerous resources related to indoor air quality in homes, including reports and web links. [www.epa.gov/iaq](http://www.epa.gov/iaq)
- HUD Smoke-Free Housing Tool Kit: [portal.hud.gov/hudportal/documents/huddoc?id=pdfowners.pdf](http://portal.hud.gov/hudportal/documents/huddoc?id=pdfowners.pdf)
- Minnesota Smoke-Free Housing: [www.mnsmokefreehousing.org](http://www.mnsmokefreehousing.org)
- Online record of LISC webinar: “Going Smoke Free: Best Practices of Multifamily Housing Owners & Managers”: [www.instituteccd.org/resources/4724](http://www.instituteccd.org/resources/4724)

## OPERATIONS, MAINTENANCE & OCCUPANT ENGAGEMENT

EDUCATIONAL MATERIALS AND ORIENTATIONS HELP EDUCATE RESIDENTS AND STAFF ON GREEN FEATURES THAT WERE DESIGNED TO DELIVER HEALTH, ECONOMIC AND ENVIRONMENTAL BENEFITS, AS WELL AS THEIR ROLE IN REALIZING THOSE BENEFITS IN THEIR OWN LIVES.

INTRODUCTION CRITERIA  
CHECKLIST  
1 INTEGRATIVE DESIGN  
2 LOCATION +  
NEIGHBORHOOD FABRIC  
3 SITE IMPROVEMENTS  
4 WATER CONSERVATION  
5 ENERGY EFFICIENCY  
6 MATERIALS  
7 HEALTHY LIVING  
ENVIRONMENT  
8 OPERATIONS,  
MAINTENANCE  
& OCCUPANT  
ENGAGEMENT  
APPENDIX

## 8.1 BUILDING OPERATIONS & MAINTENANCE (O&M) MANUAL AND PLAN MANDATORY

### *REQUIREMENTS*

Develop a manual with thorough building operations & maintenance guidance and a complementary plan. The manual and plan should be developed over the course of the project design, development and construction stages and should include sections/chapters addressing the following topics:

- Operations & maintenance guidance for all mechanical and electrical equipment and appliances (building level and dwelling unit/office level)
- HVAC specifications, and operations & maintenance schedules
- Operations, maintenance and replacement guidance for any other specialized systems (e.g., solar photovoltaics, solar water heating, ground source heating, microgrid) within the project
- Location of mechanical, electrical, gas and water-system turnoffs
- Lighting equipment specifications and replacement guidance
- Landscaping and hardscaping specifications and maintenance plan, including any specific instructions for community gardens or growing spaces
- Green cleaning product specifications and cleaning schedules
- Pest control guidelines, referencing the Integrated Pest Management strategies developed in Criterion 7.10
- Building accessibility for residents, including security and safety protocols, whether by leaving doors unlocked, by using a security device such as a card key, or by other measures
- Maintenance of active recreation and play spaces (e.g., playgrounds, ground markings, exercise equipment) for adults, youth and children
- Information on how energy and water information will be collected and reviewed to ensure that the project is meeting performance goals (see Criterion 8.5)
- An occupancy turnover plan that describes the dwelling unit or office space turnover process, including all materials that are frequently replaced at turnover and the process for educating the building occupants about proper use and maintenance of all building systems

### *RATIONALE*

Regular building Operations & Maintenance (O&M) practices using green methods minimizes building maintenance needs and utility consumption, and provides a healthy, safe and durable living environment for residents. Developing a building O&M manual and complementary plan throughout the project design, development and construction stages allows the project team to properly customize these documents with the input of project installers.

## RECOMMENDATIONS

Begin creating a thorough and well-developed O&M manual and plan well before construction completion. Work with designers, systems installers and operations staff to assemble critical information and schedules for best-practice operations and maintenance strategies.

### **Prior to, and while the project is under construction:**

During the design process, keep a running list of how maintenance and landscaping teams and building occupants may need to be involved with the building in order to ensure that it will perform as intended. Once the project team has completed the integrative design process (see Category 1), amend templates of O&M documents with project-specific information for maintenance staff and building occupants. By working in this manner, the building O&M manual and plan will be informed by the development process and completed by the time the project is ready for occupancy.

- Identify the senior management position(s) with oversight responsibility for O&M and the job roles responsible for producing, managing and/or implementing the manual and plan.
- Ensure that the building performance goals/requirements that were established for the project during integrative design will be included in the O&M manual and plan.
- Create a knowledge-transfer plan to ensure that accurate as-built information is captured during construction, start-up and commissioning, and integrated into the O&M manual and plan (e.g., if possible, create a video of the commissioning agent or system installer showing key maintenance checks to use when training staff).
- Discuss your building O&M training plan to ensure that responsible staff will be up to speed on the operation of the building prior to turnover and occupancy.
- Develop a succession plan to ensure that important information is retained from departing staff and transferred to new staff. This could include an exit interview checklist, maintenance log review, etc.

### **As construction nears completion and into operations:**

Finalize your building O&M manual and plan. Clearly identify key operations and maintenance activities, assign those activities to a person/job role and establish a schedule to verify that maintenance is performed. To enhance your O&M manual and plan, include:

- Account information on your energy and water performance tracking software. Identify who will monitor this account and at what interval, and what procedures will take place if irregularities are discovered.
- HVAC maintenance plans. Develop a maintenance schedule for HVAC systems, and include assignments of key tasks to specific job roles. Create a system to track when/what maintenance tasks were completed.
- Information on lighting equipment, including specs for replacement bulbs and a maintenance strategy for when to replace inaccessible fixtures (e.g., what percentage of bulbs/diodes can fail in any one lamp pylon before you install replacements).
- Location of mechanical, electrical, gas and water-system turnoffs.
- Irrigation system maintenance plans (if a grandfathered in existing system is in place, otherwise no irrigation allowed (criterion 4.7)). Develop a periodic visual inspection of functions (irrigation systems are often scheduled to operate when O&M staff are off duty).
- Landscaping and hardscapes (paved surfaces) review protocols. Develop an inspection schedule of landscaping and paving, and assign key tasks to specific job roles.
- Green cleaning products and cleaning schedules. Specify products, vendors, schedule and assignments of key tasks to specific job roles. Create a system to track when actions are completed.

- A written Integrated Pest Management policy (see Criterion 7.10) aimed at preventing pests and addressing conditions conducive to pests. Repair and maintain structures and grounds to minimize pest-related conditions. Develop building user guidelines related to pesticide use, housekeeping and prompt reporting of pest problems, such as cockroaches, rodents and bed bugs. Ensure that anyone applying pesticides is licensed and working under a scope that includes IPM provisions.
- If the project is utilizing recycled water (greywater), design and institute a policy that requires biodegradable soaps, cleaners and other products if they are going to be flushed down the drains.
- Video-record installers of mechanical systems explaining best practices for regular maintenance and strategies to address common system problems. Use this video as part of your maintenance staff training.
- Provide maintenance staff with local information for handling hazardous waste.

## RESOURCES

- The Center on Sustainable Communities Homeowner Handbook: [icosc.com/wp-content/uploads/2014/02/COSCHomeownerHandbook1.pdf](https://icosc.com/wp-content/uploads/2014/02/COSCHomeownerHandbook1.pdf)
- Enterprise Green Communities, Building Maintenance Manual Templates in Information Resources: [www.enterprisecommunity.org/resources/green-operations-and-maintenance-manual-template-13403](http://www.enterprisecommunity.org/resources/green-operations-and-maintenance-manual-template-13403)
- National Center for Healthy Housing, “Healthy Homes Maintenance Checklist”: [www.nchh.org/Portals/0/Contents/Maintenance\\_Checklist2009.pdf](http://www.nchh.org/Portals/0/Contents/Maintenance_Checklist2009.pdf)
- Stewards of Affordable Housing for the Future (SAHF), Multifamily Energy and Water Management Toolkit: This toolkit (including checklists, worksheets and resources) helps improve energy and water management, reduce costs and spending, and minimize environmental impacts over the long-term, while helping to preserve affordable properties. [www.sahfnet.org/our-work/energy-and-water-conservation/operations-maintenance](http://www.sahfnet.org/our-work/energy-and-water-conservation/operations-maintenance)
- The DOE’s Pacific Northwest National Laboratory produced “Operations & Maintenance Best Practices: A Guide to Achieving Operational Efficiency:” [www.pnnl.gov/main/publications/external/technical\\_reports/PNNL-19634.pdf](http://www.pnnl.gov/main/publications/external/technical_reports/PNNL-19634.pdf)
- ENERGY STAR Maintenance Checklist: [www.energystar.gov/index.cfm?c=heat\\_cool.pr\\_maintenance](http://www.energystar.gov/index.cfm?c=heat_cool.pr_maintenance)
- ASHRAE Guideline 1.4P: 2014 — Published Guideline Procedures for Preparing Facility Systems Manuals provides procedures for producing a Systems Manual as a resource for training, operations, maintenance and upgrading of facilities. [osr.ashrae.org/Public%20Review%20Draft%20Standards%20Lib/GPC%201%204%20Systems%20Manual%20Public%20Review%2010-12-13\\_chair\\_approved.pdf](http://osr.ashrae.org/Public%20Review%20Draft%20Standards%20Lib/GPC%201%204%20Systems%20Manual%20Public%20Review%2010-12-13_chair_approved.pdf)
- The Whole Building Design Guide has a “Comprehensive Facility Operation and Maintenance Manual:” [www.wbdg.org/facilities-operations-maintenance/comprehensive-facility-operation-maintenance-manual](http://www.wbdg.org/facilities-operations-maintenance/comprehensive-facility-operation-maintenance-manual)
- ASHRAE Guideline 32-2012 — Sustainable, High-Performance Operations and Maintenance offers guidance for operating and maintaining buildings with goals of sustainability and high performance in mind. [www.ashrae.org/resources--publications/bookstore/guideline-32-2012](http://www.ashrae.org/resources--publications/bookstore/guideline-32-2012)
- ASHRAE Training for O&M: [www.ashrae.org/education--certification/self-directed-or-group-learning/fundamentals-of-building-operation-maintenance-and-management](http://www.ashrae.org/education--certification/self-directed-or-group-learning/fundamentals-of-building-operation-maintenance-and-management)
- GPRO Operations & Maintenance Essentials provides tools for building professionals to transition from conventional to sustainable operations. [gpro.org/courses/ome](http://gpro.org/courses/ome)

## 8.2 EMERGENCY MANAGEMENT MANUAL

### FOR ALL MULTIFAMILY PROJECTS

#### MANDATORY

#### REQUIREMENTS

Provide a manual on emergency operations targeted toward operations and maintenance staff and other building-level personnel. The manual should address responses to various types of emergencies, leading with those that have the greatest probability of negatively affecting the project. The manual should provide guidance as to how to sustain the delivery of adequate services throughout an emergency and cover a range of topics including but not limited to:

- communication plans for staff and building occupants to use in the event of an emergency
- useful contact information for public utility and other service providers
- infrastructure and building “shutdown” procedures

Emergency Management Manuals should be responsive to information generated from successful completion of Criterion 1.3a Resilient Communities: Design for Resilience and, if applicable, Criterion 1.3b Resilient Communities: Multi-Hazard Risk / Vulnerability Assessment.

This information should be readily available to all building occupants, staff and visitors.

#### RATIONALE

In the event of an emergency, time is of the essence. Creating and socializing a plan for building managers and occupants before an emergency occurs increases the likelihood that disturbances due to the emergency (whether it be flooding, earthquake, power outages or another disturbance) can be appropriately mitigated.

#### RECOMMENDATIONS

- Emergency Maintenance Manuals should be updated annually (at a minimum) in both digital and hard-copy formats, and located in a well-marked location.
- Reviewing and updating all Emergency Maintenance Manuals should be built into the job description and performance requirements of staff members.
- Consider having staff trained in first aid, cardiopulmonary resuscitation (CPR) and the use of automated external defibrillators (AEDs), and include information about these resources within the Emergency Management Manual.

#### RESOURCES

- Iowa Homeland Security and Emergency Management. [homelandsecurity.iowa.gov](http://homelandsecurity.iowa.gov)
- Enterprise Disaster Response Staffing Plan: [www.enterprisecommunity.org/solutions-and-innovation/green-communities/tools-and-services/ready-respond-disaster-staffing-toolkit](http://www.enterprisecommunity.org/solutions-and-innovation/green-communities/tools-and-services/ready-respond-disaster-staffing-toolkit)
- “Ready” is a public service campaign designed to education and empower Americans to prepare for and respond to emergencies, including natural and man-made disasters. The goal of the campaign is to get the public involved and ultimately to increase the level of basic preparedness across the nation. [www.ready.gov](http://www.ready.gov)
- Federal Emergency Management Agency (FEMA): [www.fema.gov](http://www.fema.gov)

- American Red Cross: [www.redcross.org](http://www.redcross.org)
- Seattle Office of Emergency Management provides many valuable resources, including a Resident Disaster Recovery Booklet translated into several languages. They can be accessed online at: [www.seattle.gov/emergency/publications](http://www.seattle.gov/emergency/publications)
- Urban Green, Building Resiliency Task Force Report, Chapter 4: Better Planning, June 2013. [urbangreencouncil.org/sites/default/files/2013\\_brtf\\_summaryreport\\_0.pdf](http://urbangreencouncil.org/sites/default/files/2013_brtf_summaryreport_0.pdf)

## 8.3 OCCUPANT MANUAL

### MANDATORY

#### *REQUIREMENTS*

Provide a guide for building tenants that explains the intent, benefits, use and maintenance of building's green features and practices. The Occupant Manual should encourage green and healthy activities.

A range of topics should be discussed. Those topics should include, but are not limited to:

- a routine maintenance plan, outlining responsibilities of occupants and maintenance staff, as applicable
- operations and maintenance guidance for all lights, appliances and fixtures (e.g., dual-flush toilets) (Criteria 4.1, 4.2, 5.1a–e, 5.4, 5.5)
- heating, ventilation and air conditioning operation
- location of electrical, mechanical, gas and water-system turnoffs
- interior finish materials, including paints, caulks and flooring (Criteria 6.1, 6.2, 6.7a, 6.7b, 6.8, 6.9, 6.10)
- paving materials and landscaping (Criterion 3.4, 3.5, 3.6)
- recycling and waste management (Criteria 6.12 and 6.13)
- pest control (Criterion 7.10)
- interior Active Design features (e.g., stairwells) and signage (Criteria 7.12, 7.13, 7.14)
- information on community connectivity amenities, including transportation, car-share, bike-share and other accessibility features (Criterion 2.5, 2.8, 2.9)
- community garden and other fresh food resources (Criterion 2.12)
- special health considerations if recycled water (greywater) is used indoors (e.g., do not drink from the toilet in emergency situations)
- energy and water consumption information (Criteria 8.5 and 8.6)
- if applicable, procedures to contact building management in the case of a building-related problem
- green cleaning guidelines
- any other systems that are part of the building

#### *RATIONALE*

Education on the operations and maintenance of the building will allow occupants to fully realize the environmental, health and economic benefits that green housing offers.

## RECOMMENDATIONS

- When developing your Occupant Manual and engagement information, be sure to include the fun factor: Graphics, images, videos and social media information make your material more fun and engaging, and in turn make them more useful.
- During the design process, keep a running list of how maintenance and landscaping teams and occupants may need to be involved with the building in order to ensure that it will perform as intended. Once the project team has completed the integrative design process (see Category 1), amend templates of the O&M documents and Occupant Manual with project-specific information. By working in this manner, these documents will be informed by the development process and completed by the time the project is ready for occupancy.
- Develop an Integrated Pest Management (IPM) policy (in conjunction with Criterion 7.10) and, as part of that, develop resident guidance related to pesticide use, housekeeping and prompt reporting of pest problems with cockroaches, rodents and bed bugs. Ensure that anyone applying pesticides is licensed and working under a scope that includes IPM provisions.
- Provide occupants with information about local transportation options by including maps, public transit schedules, car and bike-share programs, and the building's bicycle amenities.
- Provide occupants with maps of neighborhood locations for physical activity and healthy food amenities, including farmers markets, community gardens, walking trails, parks, playgrounds and exercise facilities.
- Consider labeling trash, recycling and composting receptacles throughout the building: Trashcan becomes “landfill” can and is made visually distinct from recycling containers through the use of consistent colors.
- Provide occupants with the building's smoking policy (Criterion 7.15).
- If the project is utilizing greywater, design and institute a policy that requires biodegradable soaps, cleaners and any other product types that are going to be flushed down the drains.

## RESOURCES

- The Center on Sustainable Communities Homeowner Handbook: [icosc.com/wp-content/uploads/2014/02/COSCHomeownerHandbook1.pdf](https://www.icosc.com/wp-content/uploads/2014/02/COSCHomeownerHandbook1.pdf)
- Enterprise Community Partners Resource Center: Enterprise Green Communities hosts a variety of occupant engagement tools, trainings and sample manuals. Search for “Resident Engagement” at this url: [www.enterprisecommunity.org/solutions-and-innovation/green-communities/tools-and-services/resident-engagement](http://www.enterprisecommunity.org/solutions-and-innovation/green-communities/tools-and-services/resident-engagement)
- Connecticut Department of Environmental Protection, “A Green Home Is a Healthy Home”: This is a simple brochure with a readable layout and good presentation: [www.ct.gov/deep/lib/deep/p2/individual/healthyhome.pdf](http://www.ct.gov/deep/lib/deep/p2/individual/healthyhome.pdf)
- Minnesota Habitat for Humanity has several homeowner and home maintenance resources: [drive.google.com/open?id=0B3XELY7Tld8MNFhzQ3ZIS0hFd3c](https://drive.google.com/open?id=0B3XELY7Tld8MNFhzQ3ZIS0hFd3c) and [drive.google.com/open?id=0B3XELY7Tld8MM0J1clA2ZE5qXzQ](https://drive.google.com/open?id=0B3XELY7Tld8MM0J1clA2ZE5qXzQ) and [drive.google.com/open?id=0B3XELY7Tld8MWE9DcXBXM3Fia0U](https://drive.google.com/open?id=0B3XELY7Tld8MWE9DcXBXM3Fia0U) and [drive.google.com/open?id=0B3XELY7Tld8Mc2I0dVhpS3F1Nkk](https://drive.google.com/open?id=0B3XELY7Tld8Mc2I0dVhpS3F1Nkk) and [drive.google.com/open?id=0B3XELY7Tld8MQ1N5UDFua1RHaGM](https://drive.google.com/open?id=0B3XELY7Tld8MQ1N5UDFua1RHaGM)
- Home Energy Resource MN: This site provides information for homeowners on maintaining their home. It includes seasonal checklists and step-by-step instructions for general maintenance, as well as special instructions for new home buyers on maintaining their home during its first year. [homeenergyresourcemn.org/index.html](http://homeenergyresourcemn.org/index.html)

## 8.4 OCCUPANT AND PROPERTY STAFF ORIENTATION

### MANDATORY

#### *REQUIREMENTS*

Provide a comprehensive walk-through and orientation for all occupants, property manager(s) and building's operations staff. Use the appropriate manuals (see Criteria 8.1–8.3) as the base of the curriculum, and review the project's green features, operations and maintenance procedures, and emergency protocols.

For all rental properties, walk-throughs and orientations with occupants, property managers and building operations staff should take place annually, at a minimum. For home-ownership properties, walk-throughs and orientations should take place at sale.

#### *RATIONALE*

An orientation to the building and community helps educate occupants, property manager(s) and building operations staff about the green features that were designed to deliver health, economic and environmental benefits, as well as their role in realizing those benefits in their own lives and the lives of future residents. Without an orientation to the information included in the guides created through Criteria 8.1 – 8.3, that valuable information may not be used, and the project's long-term goals may not be met. Given the frequency of occupant and staff turnover in apartments, annual orientations to this information will help to ensure that all occupants are enabled to live and work in the building.

#### *RECOMMENDATIONS*

- During Property Management and Occupant Services staff trainings, focus on how the features of the building function and are maintained, and how those features help the occupants: providing comfort, protecting health, saving money, conserving resources, and also better stewardship of the environment. It is important for all staff to understand how the building and systems were designed to operate so that issues can be identified and addressed promptly.
- Occupant orientations should focus on engaging occupants in the process of both creating and maintaining a green and healthy environment as well as increasing resident awareness of on-site and nearby physical activity and healthy food amenities. Engagement orientations should be tailored to occupants and their needs and educate occupants on how to operate key features and building resources (e.g., recycling, thermostats, fans, lighting) and explain why certain building elements/features/materials were selected (e.g., less carpet in favor of smooth flooring improves indoor air quality). This thorough orientation will lead to collective improved outcomes, such as how occupant behavior affects energy, water and materials use as well as health outcomes. The orientation should also stress the important role that tenants play in reporting building-related problems so that issues can be addressed in a timely fashion.
- Consider providing occupants with a green, healthy living packet, including green cleaning materials, healthy recipes, recycling information and important contacts in case of any problems.
- Engage occupants at regular intervals (e.g., move-in, 3 months, 1 year, then annually) that coincide with existing tenant engagement to check in on behaviors and the potential need for assistance.
- Provide occupants with local information for handling household hazardous waste.
- Educate occupants and staff on building protocols for what to do in the case of an evacuation. Consider providing key staff and key tenants with additional training so they can help occupants during an emergency.

## 8.5 PROJECT DATA COLLECTION AND MONITORING SYSTEM: 100% NON-RESIDENTIAL, 15%-50% RESIDENTIAL / MIXED-USE UNITS MANDATORY

### *REQUIREMENTS*

#### **Non-Residential Projects**

For non-residential properties, collect and monitor project energy and water performance data for 100% of accounts for a minimum of five years. Allow the Iowa Economic Development Authority access to this data.

#### **Residential and Mixed-Use Projects**

Property owner /developer must agree to collect utility release forms from a percentage of occupants/units to track actual utility data of a sample of residential or non-residential spaces for a minimum of five years. (Example: Main Street redevelopment project with two upper-story residential units and one first-floor commercial bay would collect release forms and data from at least one residential unit and the commercial bay). The following table identifies the percentage of units the property owner /developer must collect and track utility data, as based on the project size in total number of units.

Number of units	Percentage of units
0 – 25 units	50%
25 – 100 units	25%
100+ units	15%

This data must be maintained in a manner that allows staff to easily access and monitor it, enabling them to make informed operations and capital planning decisions. Also allow Iowa Economic Development Authority access to this data.

For owner-occupied units, residents shall collect and monitor their energy and water performance data in a manner that allows for easy access and review, and that provides the ability to influence building operations. Also allow Iowa Economic Development Authority access to this data.

### *RATIONALE*

A data-collection and monitoring system allows project owners, on-site staff and occupants to understand project performance. This information should be used to influence future retrofit and repair work, as well as to identify day-to-day performance issues as they arise. If an issue is identified, appropriate actions can be taken to maximize project durability, cost savings and health benefits associated with the green goals of the project.

---

## RECOMMENDATIONS

- Make tenant utility release(s) an opt-out, rather than an opt-in, component of lease-up to provide property management with access to utility data for benchmarking/tracking. This data will allow maintenance staff to proactively identify poorly performing systems and identify other comfort issues that often go unreported, leading to major systems failure.
- Ensure that the training for occupants and building maintenance staff includes information on how to effectively use the data-collection, monitoring and reporting system.
- Inquire if your utility provider has a landlord portal. If so, building owners may gain access to tenant utility data through the utility at lease-up. Alternatively, inquire if your utility provider participates in the Green Button Challenge, a growing initiative which allows utility data transparency. [www.energy.gov/data/green-button](http://www.energy.gov/data/green-button)
- Whole-project energy monitoring systems (also known as smart meters) can help reduce energy consumption. Check to see if your local utility providers provide financial incentives for these.

## RESOURCES

- Iowa B3 Public Buildings Benchmarking Program identifies potential energy savings by comparing the current buildings' energy use to an energy code compliant building: [ia.b3benchmarking.com](http://ia.b3benchmarking.com)
- Multifamily housing communities can use Portfolio Manager to track weather-normalized energy use intensity (EUI), energy costs, greenhouse gas emissions and water consumption. [www.energystar.gov/buildings/facility-owners-and-managers/existing-buildings/use-portfolio-manager](http://www.energystar.gov/buildings/facility-owners-and-managers/existing-buildings/use-portfolio-manager)
- Private, fee-based, benchmarking and utility tracking tools are available. Among others, these include: WegoWise: [www.wegowise.com](http://www.wegowise.com); Energy Score Cards: [www.energyscorecards.com](http://www.energyscorecards.com) ; eGauge: [www.egauge.net](http://www.egauge.net)



## APPENDICES

**APPENDIX A:** GREEN DEVELOPMENT PLAN AND CHECKLIST

**APPENDIX B:** CERTIFICATION OF INTENT TO COMPLY

**APPENDIX C:** CERTIFICATION OF CONSTRUCTION DOCUMENT COMPLIANCE

**APPENDIX D:** CERTIFICATION OF COMPLIANCE AT END OF CONSTRUCTION

**APPENDIX E:** ENERGY PERFORMANCE CERTIFICATION

**APPENDIX F:** PROJECT PLAN AND SPEC BOOK CHECKLIST

**APPENDIX G:** AIR SEALING KEY POINTS

**APPENDIX H:** INTEGRATED DESIGN AGENDA AND OUTCOMES TEMPLATE

**APPENDIX I:** STORMWATER MANAGEMENT MILESTONE CHECKLIST

**APPENDIX J:** GLOSSARY



---

## APPENDIX A

### GREEN DEVELOPMENT PLAN AND CHECKLIST

**Please [click here to access the Green Development Plan and Checklist in Microsoft Excel format.](#)**

**Please [click here to access the Green Development Plan and Checklist in a fillable PDF form.](#)**



## APPENDIX B

### CERTIFICATION OF INTENT TO COMPLY

**REQUIRED: SUBMIT THIS CERTIFICATION AT TIME OF APPLICATION.**

The project applicant and project architect/project designer are required to sign the certification below at the time of application submittal to the Iowa Economic Development Authority. By signing this certification, the project applicant and project architect/project designer are certifying their intent to comply with all of the **MANDATORY** Iowa Green Streets Criteria applicable to the project as determined by the Iowa Economic Development Authority. This certification also certifies the intent to complete the optional Iowa Green Streets Criteria proposed in the applicant's proposal. A fillable PDF version of this form is available here: [iowaeconomicdevelopment.com/userdocs/programs/AppxB-CertificationOfIntentToComplyForm.pdf](http://iowaeconomicdevelopment.com/userdocs/programs/AppxB-CertificationOfIntentToComplyForm.pdf)

To be Completed by Applicant	
Signature:	
Name:	
Title:	
Tel. No.:	
E-mail:	
Accreditation: (if applicable)	
Date:	

To be Completed by Project Architect/Project Designer	
Signature:	
Name:	
Title:	
Tel. No.:	
E-mail:	
Accreditation: (license/ licensing body)	
Date:	



## APPENDIX C

# CERTIFICATION OF CONSTRUCTION CONTRACT DOCUMENT COMPLIANCE

**REQUIRED: SUBMIT THIS CERTIFICATION PRIOR TO STARTING CONSTRUCTION.**

The project applicant/recipient and project architect/project designer are required to sign the certification below prior to commencement of construction. By signing this certification, the project applicant and project architect/project designer are certifying that the construction documents comply with all of the **MANDATORY** Iowa Green Streets Criteria applicable to the project as determined by the Iowa Economic Development Authority. This certification also certifies that the construction documents comply with all optional Iowa Green Streets Criteria in the applicant's project proposal. A fillable PDF version of this form is available here: [iowaeconomicdevelopment.com/userdocs/programs/AppxC-CertOfConstContractDocComplianceForm.pdf](http://iowaeconomicdevelopment.com/userdocs/programs/AppxC-CertOfConstContractDocComplianceForm.pdf)

To be Completed by Applicant/Recipient	
Signature:	
Name:	
Title:	
Tel. No.:	
E-mail:	
Accreditation: (if applicable)	
Date:	

To be Completed by Project Architect/Project Designer	
Signature:	
Name:	
Title:	
Tel. No.:	
E-mail:	
Accreditation: (license/ licensing body)	
Date:	



## APPENDIX D

# CERTIFICATION OF COMPLIANCE AT END OF CONSTRUCTION

**REQUIRED: SUBMIT THIS CERTIFICATION AT TIME OF CONSTRUCTION COMPLETION.**

The project applicant/recipient, project architect/project designer, general contractor and HVAC contractor are required to sign the certification below at time of construction completion. By signing this certification, all signing parties are certifying that the project as constructed complies with all of the **MANDATORY** Iowa Green Streets Criteria applicable to the project as determined by the Iowa Economic Development Authority. This certification also certifies that the project as constructed complies with all of the optional Iowa Green Streets Criteria in the applicant's project proposal. A fillable PDF version of this form is available here:

[iowaeconomicdevelopment.com/userdocs/programs/AppxD-CertificationOfComplianceEndOfConstForm.pdf](http://iowaeconomicdevelopment.com/userdocs/programs/AppxD-CertificationOfComplianceEndOfConstForm.pdf)

To be Completed by Applicant/Recipient	
Signature:	
Name:	
Title:	
Tel. No.:	
E-mail:	
Accreditation: (if applicable)	
Date:	

To be Completed by Project Architect/Project Designer	
Signature:	
Name:	
Title:	
Tel. No.:	
E-mail:	
Accreditation: (license/licensing body)	
Date:	



<b>To be Completed by General Contractor</b>	
Signature:	
Name:	
Title:	
Tel. No.:	
E-mail:	
Accreditation: (license/licensing body)	
Date:	

<b>To be Completed by HVAC Contractor</b>	
Signature:	
Name:	
Title:	
Tel. No.:	
E-mail:	
Accreditation: (license/ licensing body)	
Date:	



## APPENDIX E

# ENERGY PERFORMANCE CERTIFICATION

### REQUIRED:

- **Residential Projects (<4 stories)** – Energy Rater submits Home Energy Rating System (HERS) certificate, Code Certificate and signs certification below for submittal by project applicant/recipient.
- **Commercial or Residential Projects >3 stories** – Energy Rater / Energy Professional submits Code Certificate and energy modeling information and completes and signs certification below for submittal by project applicant/recipient.

The project's independent, third-party energy rater or energy professional for non-residential projects is required to sign the certification below at time of construction completion. By signing this certification, the Energy Rater is certifying that the project, as constructed, complies with all of the MANDATORY Iowa Green Streets Criteria energy related criteria applicable to the project as determined by IEDA including the following criteria.

- **5.1a, Building Performance Standard – Single-Family, Multifamily ≤ 3 stories, Multifamily ≤ five stories with individual HVAC systems**
  - Energy performance requirements in Air Barrier and Insulation Inspection Component Guide and Energy Performance Table for Criterion 5-1 were met or project achieved Energy Star certification
  - HERS Index of 61 or better
  - For all equipment installed, meet or exceed the minimum performance requirements in the energy performance table in Criterion 5-1
- **5.1b, Building Performance Standard – Multifamily ≥ 4 stories**
  - Project certified through Energy Star Multifamily High Rise Program
- **5.1c, Building Performance Standard – Substantial or Moderate Rehab**
  - Applicable energy performance requirements in Air Barrier and Insulation Inspection Component Guide and Energy Performance Table for Criterion 5-1 were met
  - HERS Index of 85 or better (See exceptions in Criterion 5.1c)
- **5.1d, Building Performance Standard – Substantial or Moderate Rehab – Multifamily ≥ 4 stories, Commercial and Mixed Use**
  - Applicable energy performance requirements in Air Barrier and Insulation Inspection Component Guide and Energy Performance Table for Criterion 5-1 were met
  - Submitted to IEDA modeling information verifying meeting ASHRAE 90.1-2013



- **5.1e, Building Performance Standard – Commercial, Nonprofit, and Mixed Use**
  - Energy performance requirements in Air Barrier and Insulation Inspection Component Guide and Energy Performance Table for Criterion 5-1 were met
  - Exceed performance requirements of ASHRAE 90.1-2013 Appendix G by 10 percent
  - Passed a slab insulation and pre-drywall thermal bypass inspection by third-party RESNET Energy Rater
  - Commissioned the building
  - Submitted to IEDA modeling information verifying exceeding ASHRAE 90.1-2013 Appendix G by ≥ 10 percent
  - Completed and submitted the required Energy Review Form (only projects > 100,000 cubic feet)
- **5.3, HVAC Sizing, Installation and Duct Systems**
  - Residential Projects: Heating and cooling equipment sized in accordance with the Air Conditioning Contractors of America (ACCA) Manual, Parts D, J and S
  - Commercial Projects: ASHRAE handbooks, or equivalent software
- **5.4, ENERGY STAR Appliances (if providing appliances)**
- **5.5, Lighting**

To be Completed by Energy Rater/Energy Professional	
Signature:	
Name:	
Title:	
Tel. No.:	
E-mail:	
Accreditation: (license/licensing body)	
Date:	

A fillable PDF version of this form is available here:  
[iowaeconomicdevelopment.com/userdocs/programs/AppxE-EnergyPerformanceCertificationForm.pdf](http://iowaeconomicdevelopment.com/userdocs/programs/AppxE-EnergyPerformanceCertificationForm.pdf)



## APPENDIX F

### PROJECT PLAN AND SPEC BOOK CHECKLIST

A fillable PDF version of this form is available here:

[iowaeconomicdevelopment.com/userdocs/programs/AppxF-ProjPlanAndSpecBookChecklistForm.pdf](http://iowaeconomicdevelopment.com/userdocs/programs/AppxF-ProjPlanAndSpecBookChecklistForm.pdf)

CRITERION	PROJECT PLANS	PAGE #	SPEC BOOK	PAGE #	ARCHITECT/ DESIGNER INITIALS
1.1a Goal Setting					
1.1b Criteria Documentation					
1.2a Occupant Health and Well-Being: Design for Health					
1.2b Occupant Health and Well-Being: Health Action Plan					
1.3a Resilient Communities: Design for Resilience					
1.3b Resilient Communities Multi-Hazard Risk / Assessment					
2.1 Sensitive Site Protection					
2.2 Connections to Existing Development and Infrastructure					
2.3-4 Compact Development					
2.5 Proximity to Services					
2.6-7 Preservation of and Access to Open Space					
2.8 Access to Public Transportation					
2.9 Improving Connectivity to the Community					
2.10 Passive Solar Heating/Cooling					
2.11 Grayfield, Brownfield or Adaptive Reuse					
2.12 Access to Fresh, Local Foods					
2.13 LEED for Neighborhood Development					
3.1 Environmental Remediation					
3.2 Erosion and Sedimentation Control					
3.3 Low-Impact Development					
3.4 Landscaping					
3.5 Surface Water Management					
3.6 Reducing Heat-Island Effect: Paving					
4.1 Water-Conserving Fixtures					
4.2 Advanced Water Conservation					
4.3 Leaks and Water Metering					
4.4 Efficient Plumbing Layout and Design					
4.5 Water Reuse					
4.6 No Irrigation and Irrigation with Harvested Water					
5.1 Building Performance Requirements					



CRITERION	PROJECT PLANS	PAGE #	SPEC BOOK	PAGE #	ARCHITECT/ DESIGNER INITIALS
5.1a–e Building Performance Standards					
5.2 Additional Reductions in Energy Use					
5.2b Advanced Certification: Nearing Net Zero					
5.3 Sizing of Heating and Cooling Equipment					
5.4 ENERGY STAR Appliances					
5.5a Lighting					
5.6 Electricity Meter					
5.7a Photovoltaic / Solar Hot Water Ready					
5.7b Renewable Energy					
5.8a Resilient Energy Systems: Floodproofing					
5.8b Resilient Energy Systems: Islandable Power					
5.9 Advanced Framing					
5.10 Advanced Metering Infrastructure					
6.1 Low/No VOC Paints and Primers					
6.2 Low/No VOC Adhesives and Sealants					
6.3 Recycled Content Material					
6.4 Regional Materials					
6.5 Certified, Salvaged, and Engineered Wood Products					
6.6 Composite Wood Products that Emit Low/No Formaldehyde					
6.7a-b Environmentally Preferable Flooring					
6.8 Mold Prevention: Services					
6.9 Mold Prevention: Tub and Shower Enclosures					
6.10 Asthmagen-Free Materials					
6.11 Reducing Heat-Island Effect: Roofing					
6.12 Construction Waste Management					
6.13 Recycling Storage					
7.1 Ventilation					
7.2 Clothes Dryer Exhaust					
7.3 Combustion Equipment					
7.4 Elimination of Combustion Within the Conditioned Space					
7.5 Vapor Retarder Strategies					
7.6 Water Drainage					
7.7 Mold Prevention: Water Heaters					
7.8 Radon Mitigation					
7.9 Garage Isolation					
7.10 Integrated Pest Management					



CRITERION	PROJECT PLANS	PAGE #	SPEC BOOK	PAGE #	ARCHITECT/ DESIGNER INITIALS
7.11a-b Beyond ADA: Universal Design					
7.12 Active Design: Promoting Physical Activity Within the Building					
7.13 Active Design: Staircases and Building Circulation					
7.14 Interior and Outdoor Activity Spaces for Children and Adults					
7.15 Smoke Free Building					
8.1 Building Operations and Maintenance (O&M) Manual and Plan					
8.2 Emergency Management Manual					
8.3 Occupant Manual					
8.4 Occupant and Property Manager(s) Orientation					
8.5 Project Data Collection and Monitoring System					



# APPENDIX G

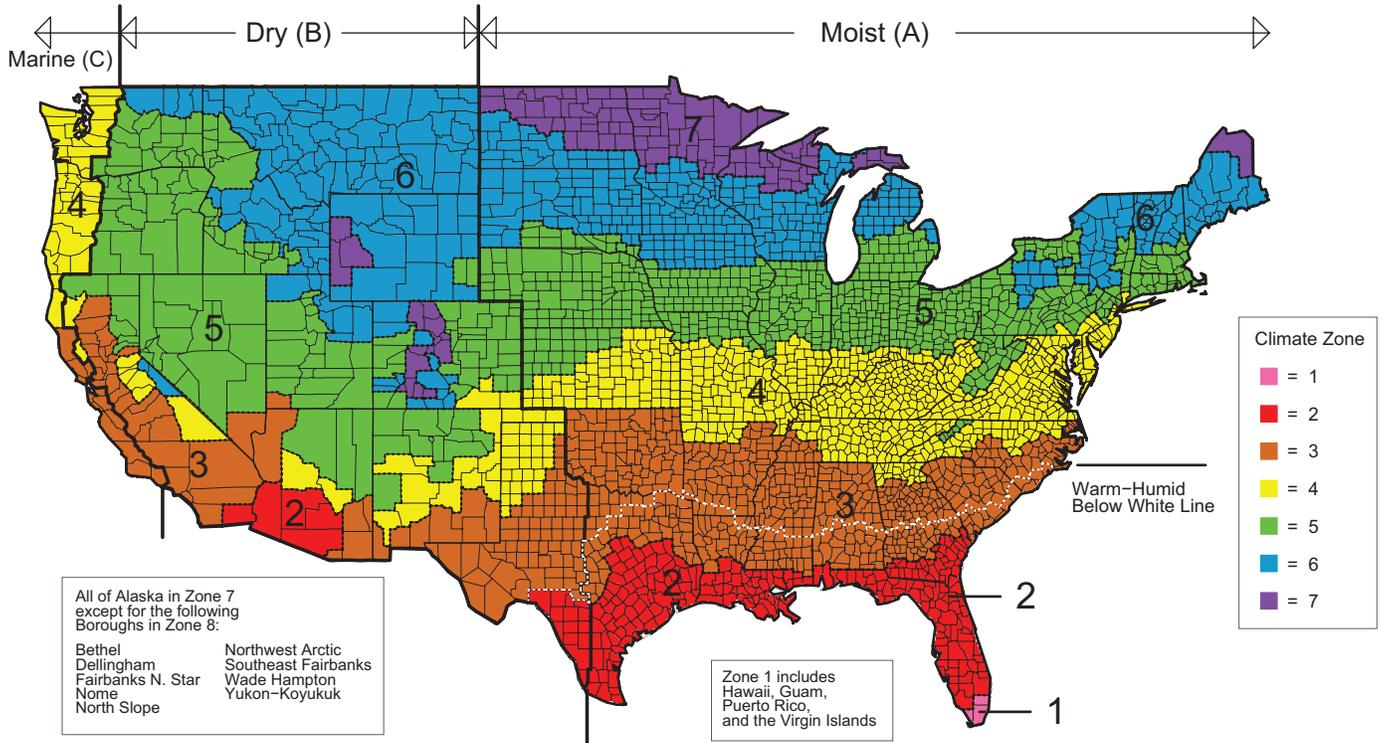



## 2015 IECC CLIMATE ZONE MAP

### AIR BARRIER AND INSULATION INSPECTION COMPONENT GUIDE

COMPONENT	CRITERIA
Air barrier and thermal barrier	<b>Exterior</b> thermal envelope insulation for framed walls is installed in substantial contact and continuous alignment with building envelope air barrier
	Breaks or joints in the air barrier are filled or repaired
	Air-permeable insulation is not used as a sealing material
Ceiling/attic	Air barrier in any dropped ceiling / soffit is substantially aligned with insulation and any gaps are sealed
	Attic access (except unvented attic), knee-wall door, or drop-down stair is insulated and sealed or in conditioned space
Walls	Corners and headers are insulated; junction of foundation and sill plate is sealed
Windows and doors	Space between window / door jambs and framing is sealed – No stuffing of fiberglass insulation is allowed
Rim joists	Rim joists are insulated and include an air barrier following included reference to best practice example
Floors (including above-garage cantilevered floors)	Insulation is installed to maintain permanent contact with the area it is insulating
	Air barrier is installed at any exposed edge of insulation
Crawl space walls	Insulation is permanently attached to walls. No poly or vinyl faced insulation. Follow included reference to best practice example
	Exposed earth in unvented crawl spaces is covered with Class I vapor barrier with overlapping joints taped
Shafts, penetrations	Duct shafts, utility penetrations, knee walls, and flue shafts opening to exterior or unconditioned spaces are sealed
Narrow cavities	Batts in narrow cavities are cut to fit, or narrow cavities are filled with sprayed / blown insulation. Narrow cavities are defined as 4 inches wide or less
Garage separation	Air sealing is provided between the garage and conditioned spaces and door assembly meets fire code.
Recessed lighting	Recessed light fixtures are airtight, ICAT rated, & sealed to drywall
	Exception — fixtures in conditioned space
Plumbing and wiring	Insulation is placed between the exterior wall and the pipes
	Batt insulation is cut to fit around wiring and plumbing, or sprayed / blown insulation extends behind piping and wiring
Shower / tub on exterior wall	Showers and tubs on exterior walls have insulation and an air barrier separating them from the exterior wall
Electrical / phone box	Air barrier extends behind boxes or air-sealed-type boxes are installed on exterior walls
Common wall	Air barrier is installed in common wall between dwelling units and air infiltration is treated like an exterior wall – common walls need to be considered as an exterior wall for air sealing
HVAC register boots	HVAC register boots that penetrate building envelope are sealed to subfloor or drywall
Fireplace	Fireplace walls include an air barrier



**AIR SEALING KEY POINTS**

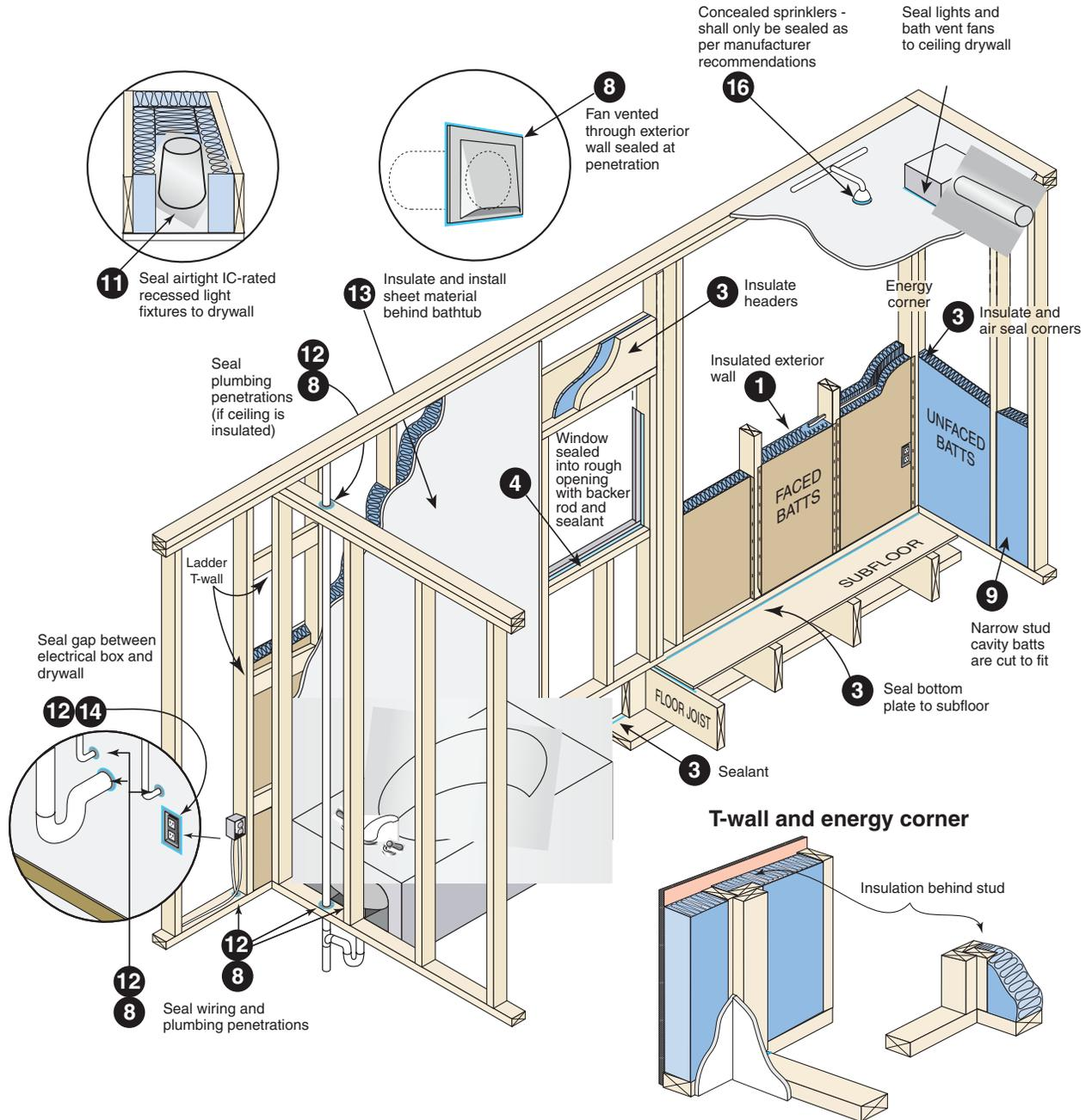

This document is intended solely to help graphically demonstrate the air leakage provisions of the 2015 IECC. It does not cover all air sealing location or techniques. Other code provisions may be applicable as well. *Image courtesy of Southface. Reprinted with permission.*



**AIR SEALING KEY POINTS (continued)**

**Chases and common by-passes**

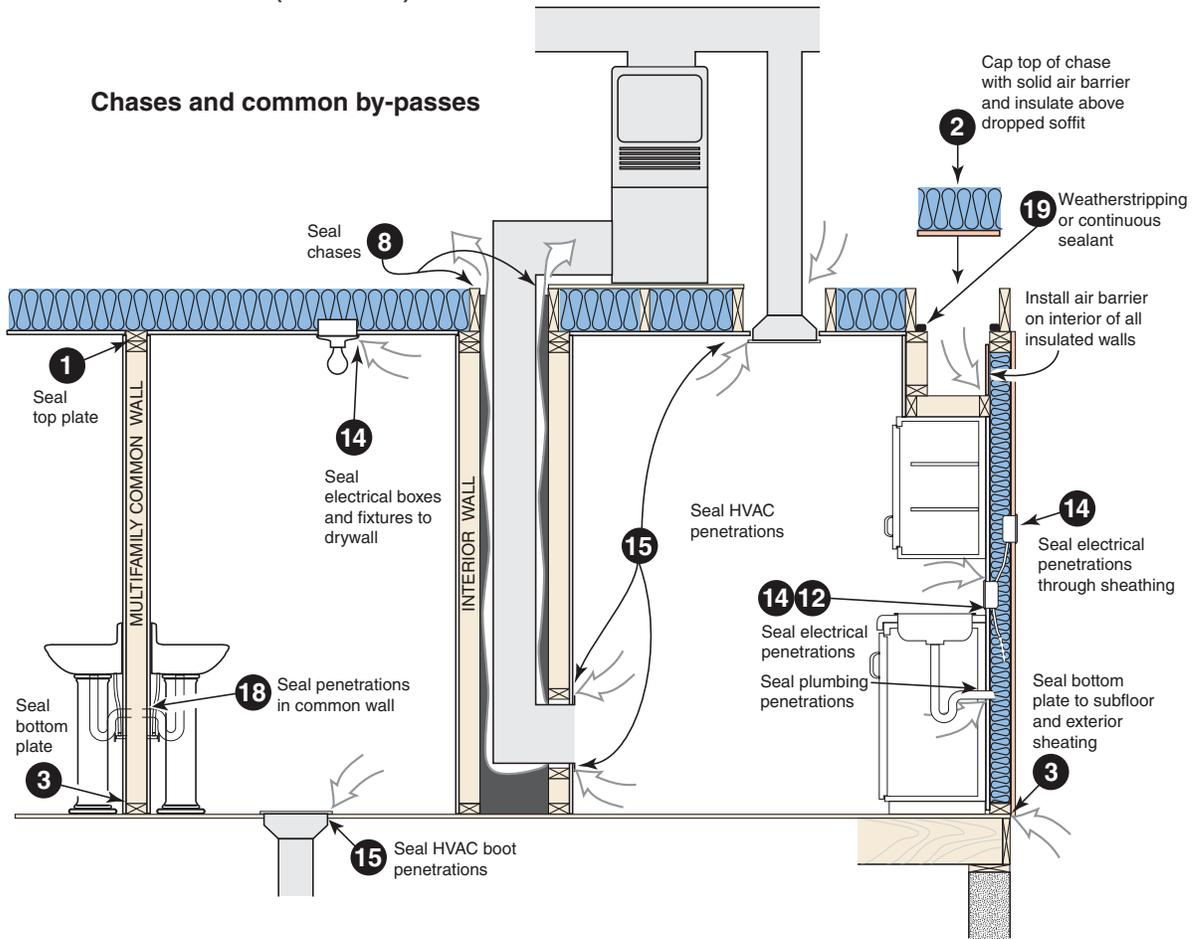

**Shower/tub drain rough opening**

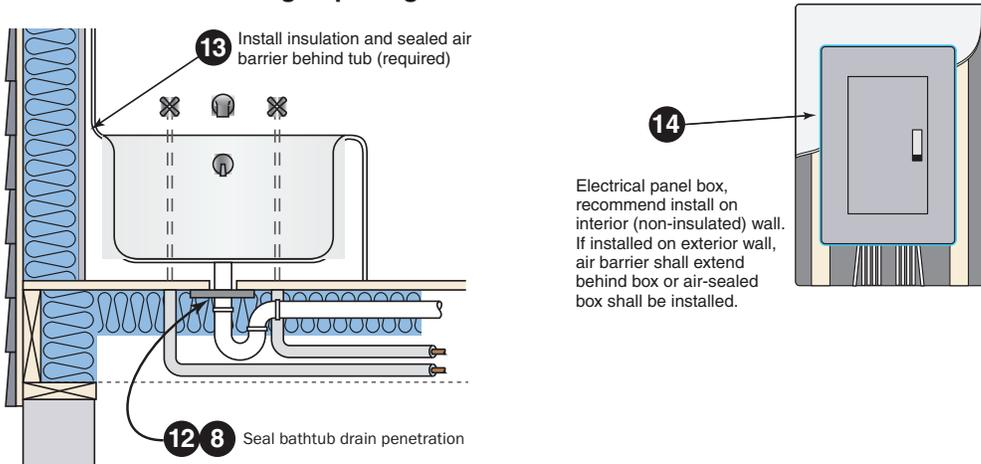

This document is intended solely to help graphically demonstrate the air leakage provisions of the 2015 IECC. It does not cover all air sealing location or techniques. Other code provisions may be applicable as well. *Image courtesy of Southface. Reprinted with permission.*



AIR SEALING KEY POINTS (continued)

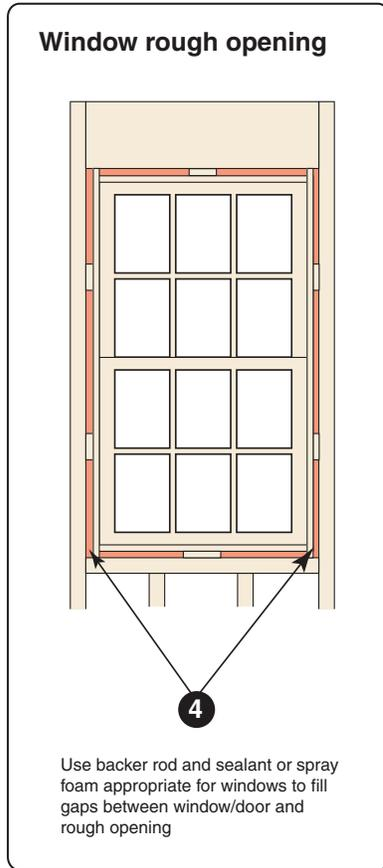

### Wall cross-section

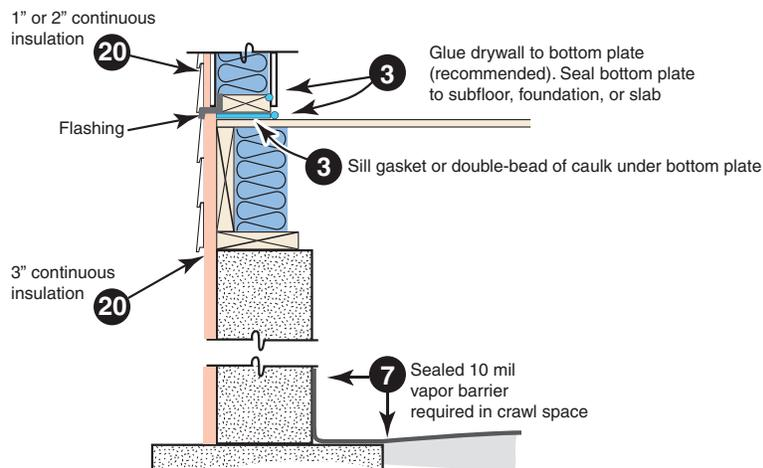
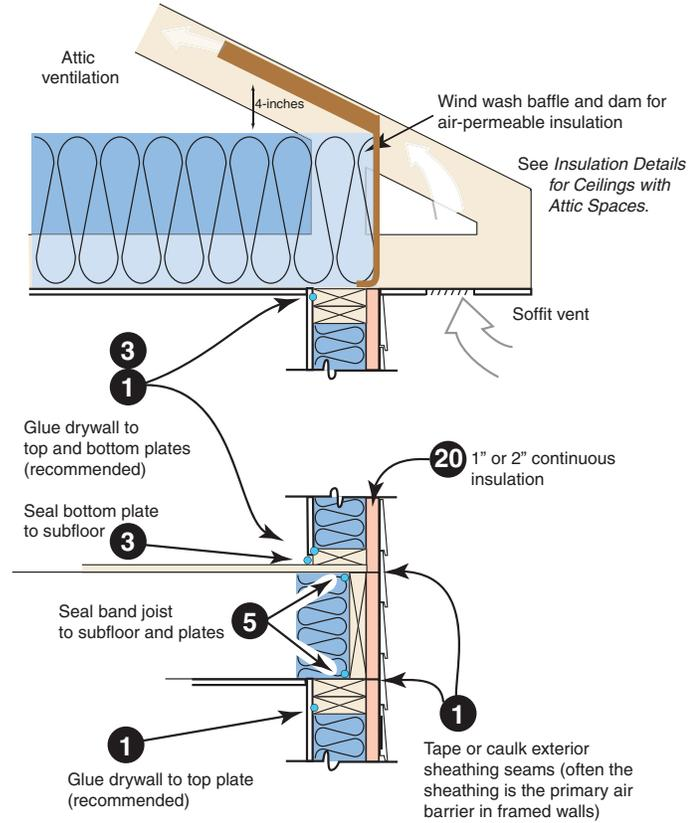

This document is intended solely to help graphically demonstrate the air leakage provisions of the 2015 IECC. It does not cover all air sealing location or techniques. Other code provisions may be applicable as well. *Image courtesy of Southface. Reprinted with permission.*



**AIR SEALING KEY POINTS (continued)**

**Combustion chase penetrations**

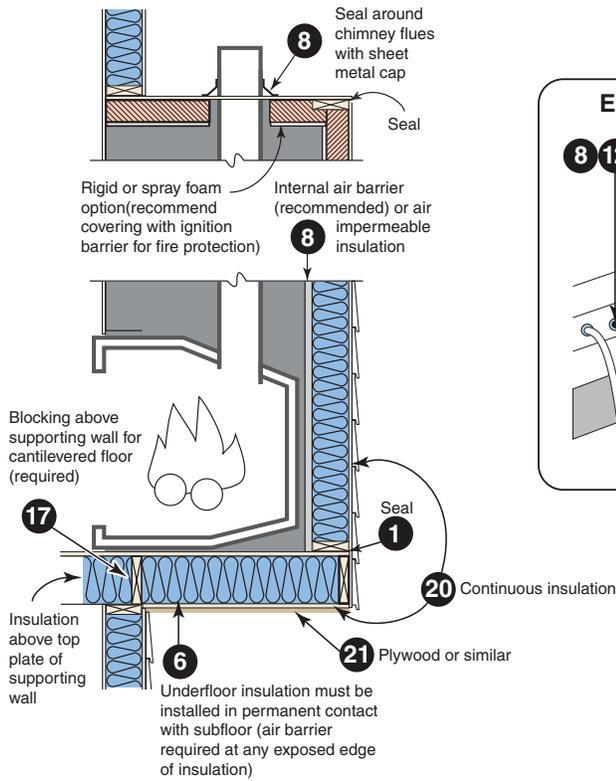

**Exterior penetrations**

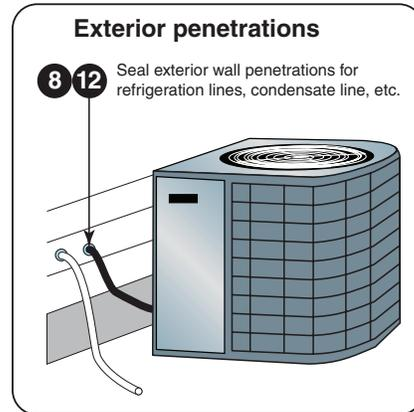

This document is intended solely to help graphically demonstrate the air leakage provisions of the 2015 IECC. It does not cover all air sealing location or techniques. Other code provisions may be applicable as well. *Image courtesy of Southface. Reprinted with permission.*



**AIR SEALING KEY POINTS (continued)**

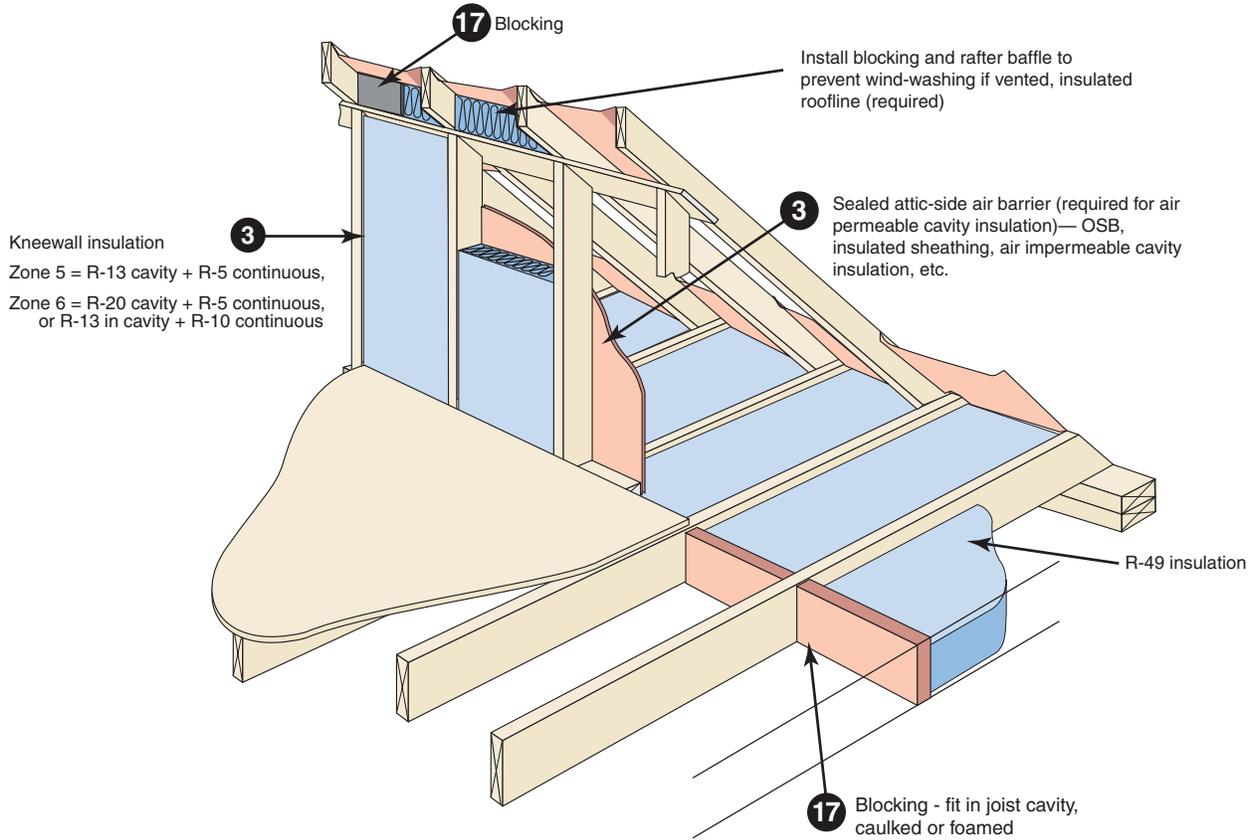

**Attic knee-walls**

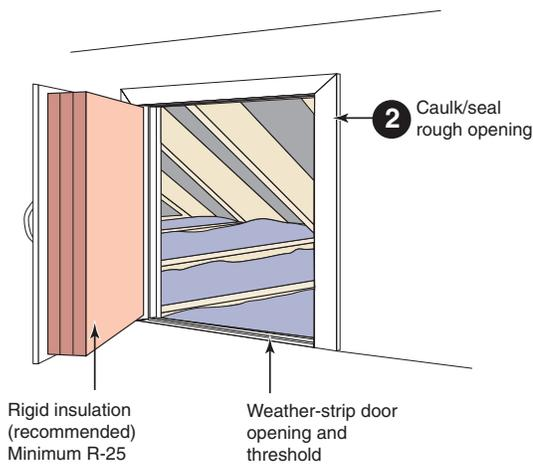

**Two-level attic**

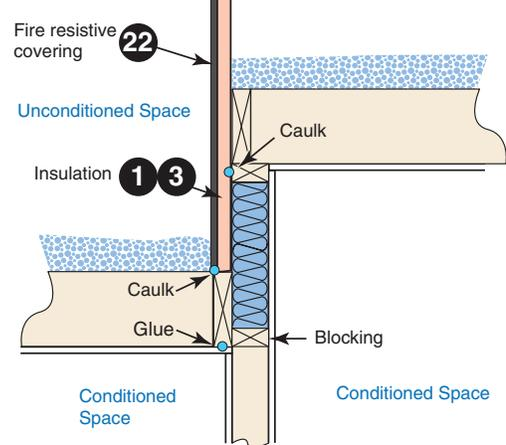

This document is intended solely to help graphically demonstrate the air leakage provisions of the 2015 IECC. It does not cover all air sealing location or techniques. Other code provisions may be applicable as well. *Image courtesy of Southface. Reprinted with permission.*



**AIR SEALING KEY POINTS (continued)**

**Attic scuttle**

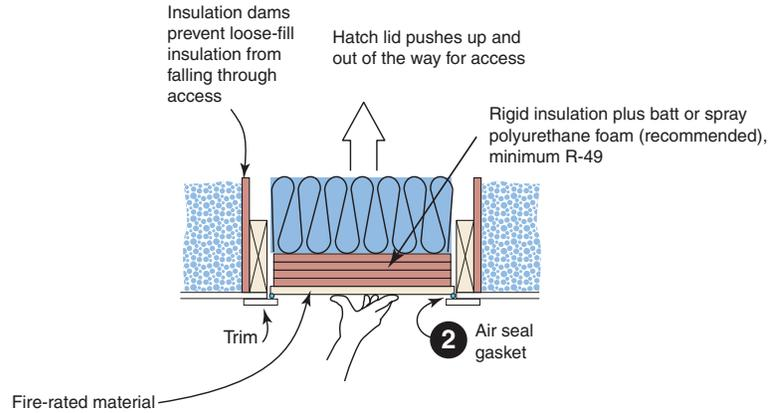

**Attic pull-down stairs**

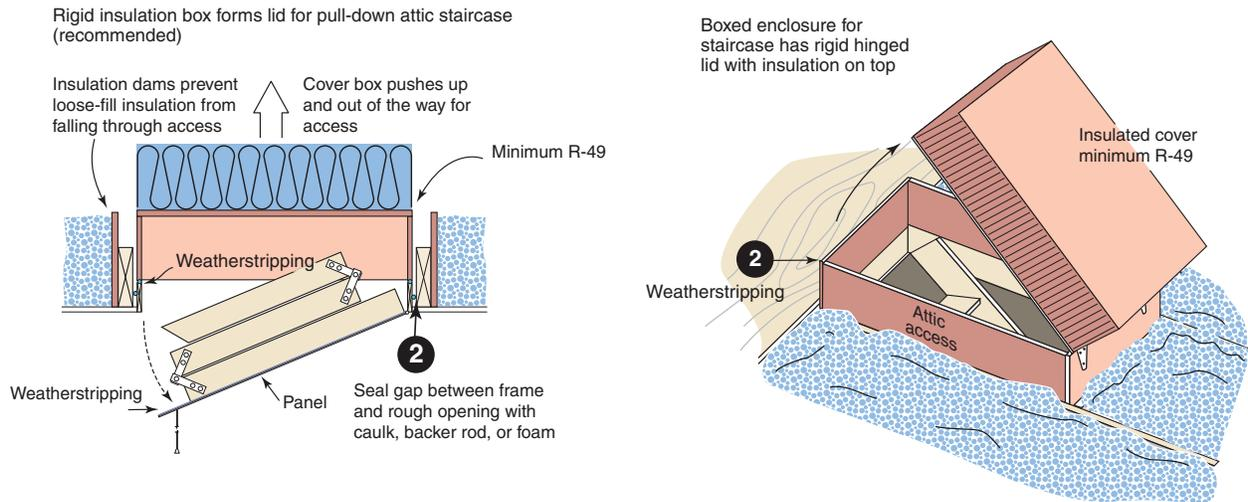

This document is intended solely to help graphically demonstrate the air leakage provisions of the 2015 IECC. It does not cover all air sealing location or techniques. Other code provisions may be applicable as well. *Image courtesy of Southface. Reprinted with permission.*



**AIR SEALING KEY POINTS (continued)**

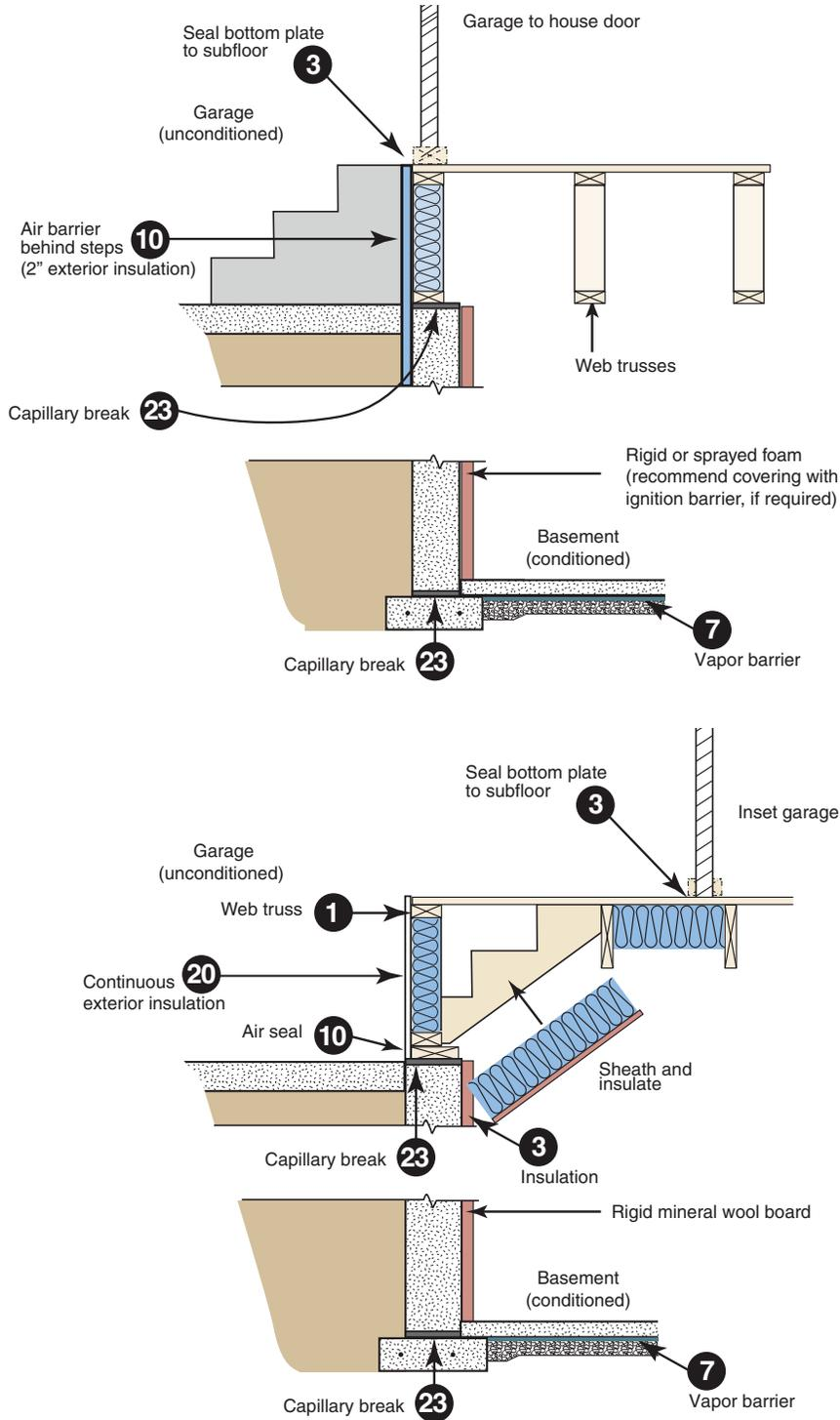

This document is intended solely to help graphically demonstrate the air leakage provisions of the 2015 IECC. It does not cover all air sealing location or techniques. Other code provisions may be applicable as well. *Image courtesy of Southface. Reprinted with permission.*



**AIR SEALING KEY POINTS (continued)**

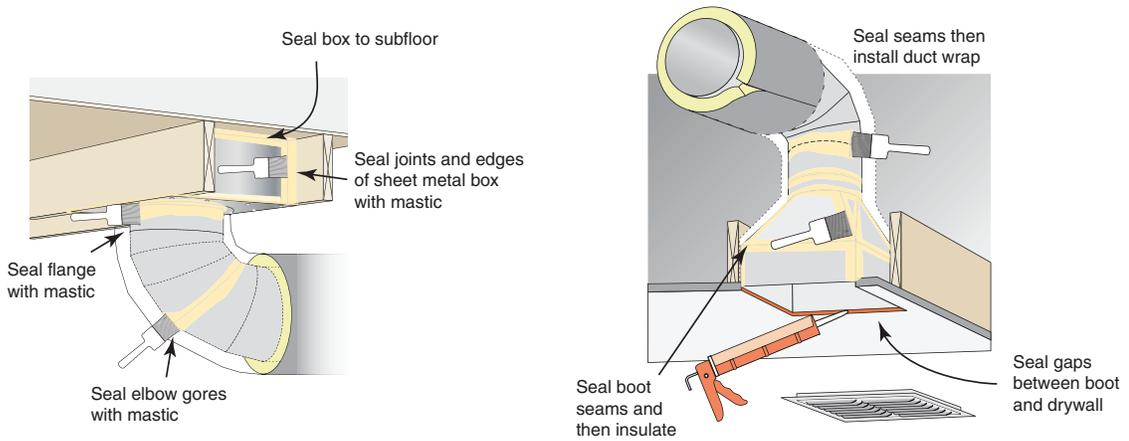
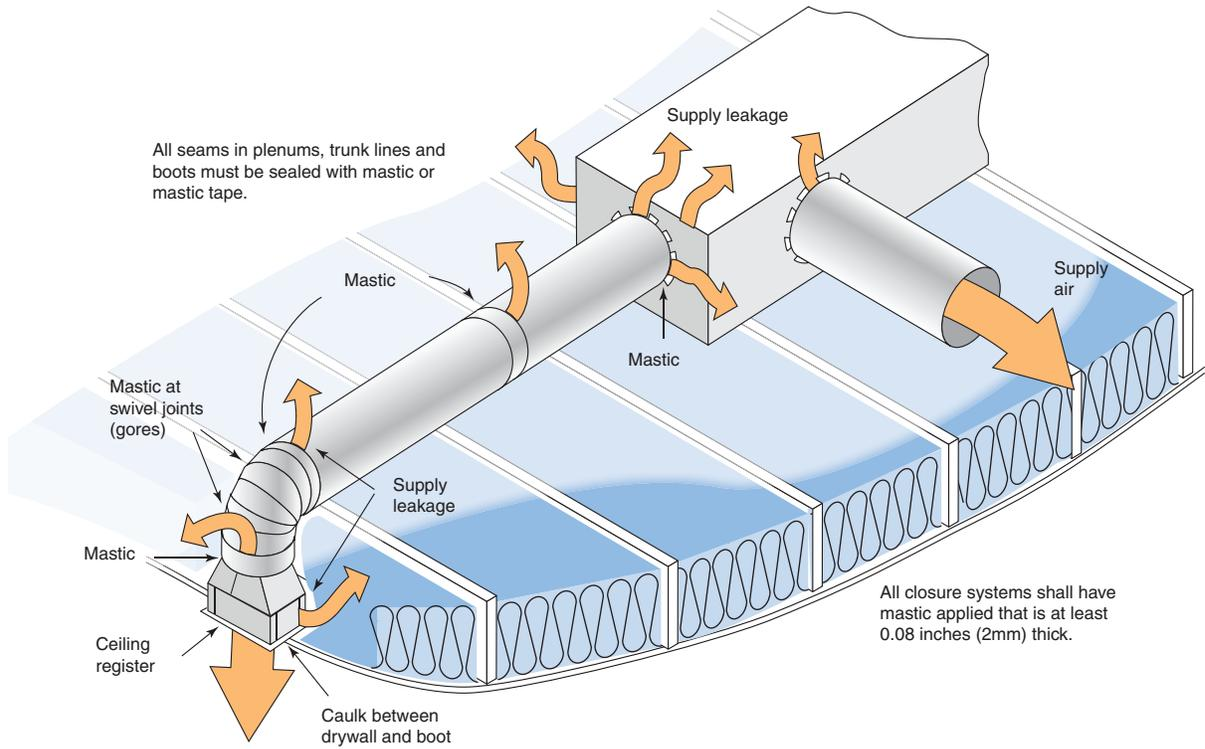

This document is intended solely to help graphically demonstrate the air leakage provisions of the 2015 IECC. It does not cover all air sealing location or techniques. Other code provisions may be applicable as well. *Image courtesy of Southface. Reprinted with permission.*



**AIR SEALING KEY POINTS (continued)**

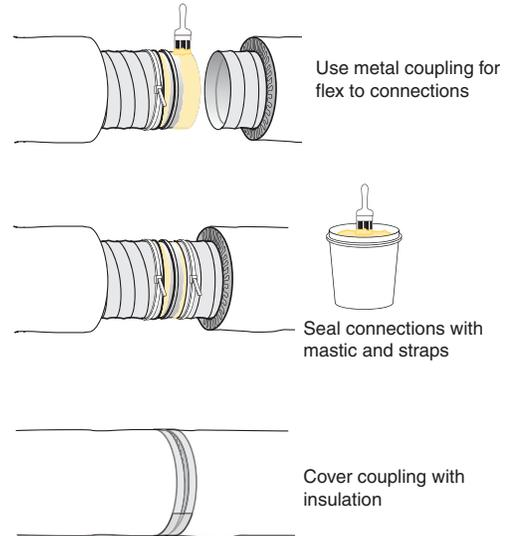
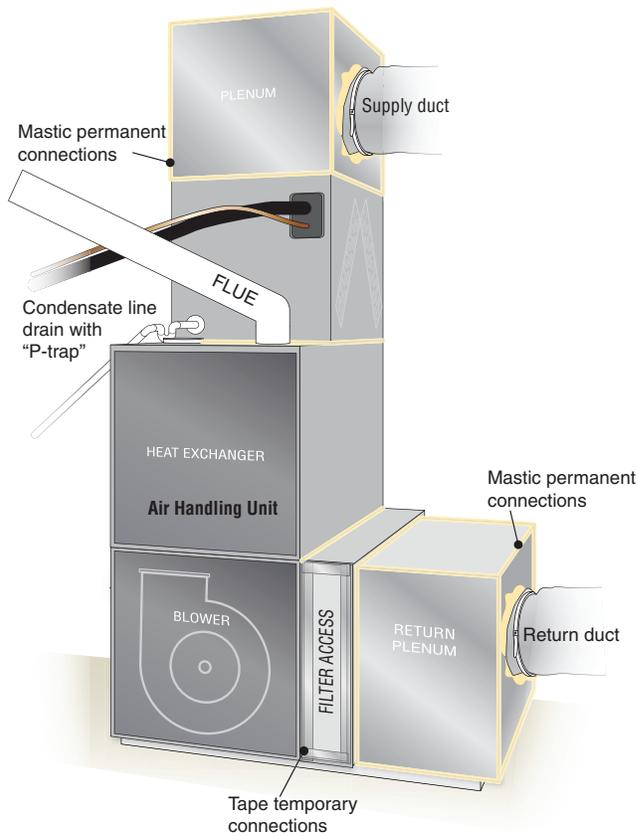
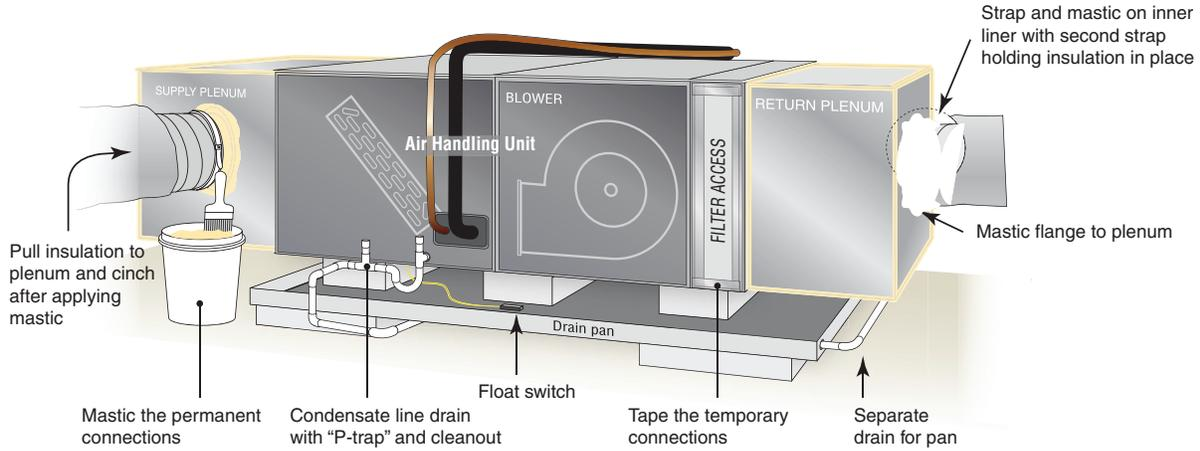

This document is intended solely to help graphically demonstrate the air leakage provisions of the 2015 IECC. It does not cover all air sealing location or techniques. Other code provisions may be applicable as well. *Image courtesy of Southface. Reprinted with permission.*



## AIR SEALING KEY POINTS (continued)

### Multifamily Air-sealing Details

- 8 Cap and seal all chases including chases for grouped utility lines and radon vents

*Seal penetrations in mechanical closet including penetrations for the:*

- 8 supply plenum
  - 8 outside air ventilation
  - 8 12 refrigerant line
  - 12 plumbing
  - 12 14 electrical
  - 12 gas fuel
- 5 Seal band area at exterior sheathing side and all penetrations through band
  - 1 3 UL-compliant air sealing at drywall finishing for any wall adjacent to stairwell or elevator. Air seal this gap at every change in floor level
  - 8 Seal miscellaneous clustered penetrations through building envelope (e.g. refrigerant lines)

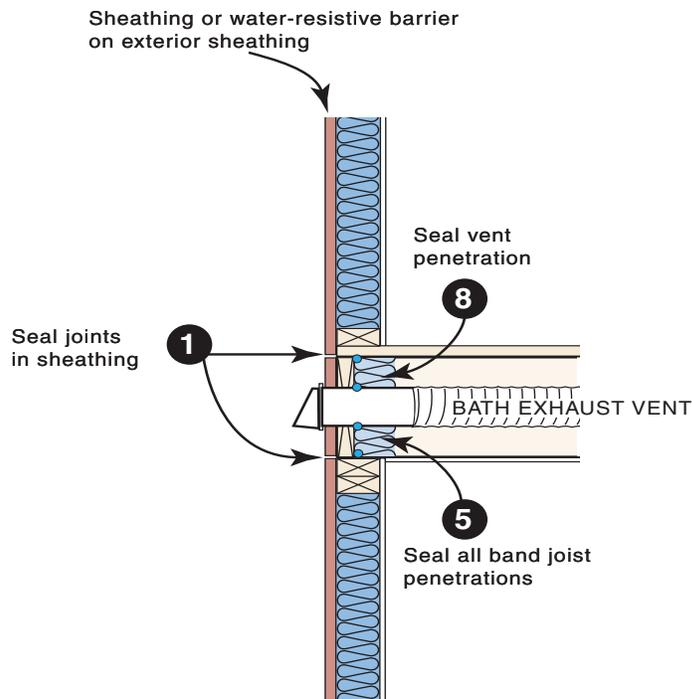

This document is intended solely to help graphically demonstrate the air leakage provisions of the 2015 IECC. It does not cover all air sealing location or techniques. Other code provisions may be applicable as well. *Image courtesy of Southface. Reprinted with permission.*



**AIR SEALING KEY POINTS (continued)**

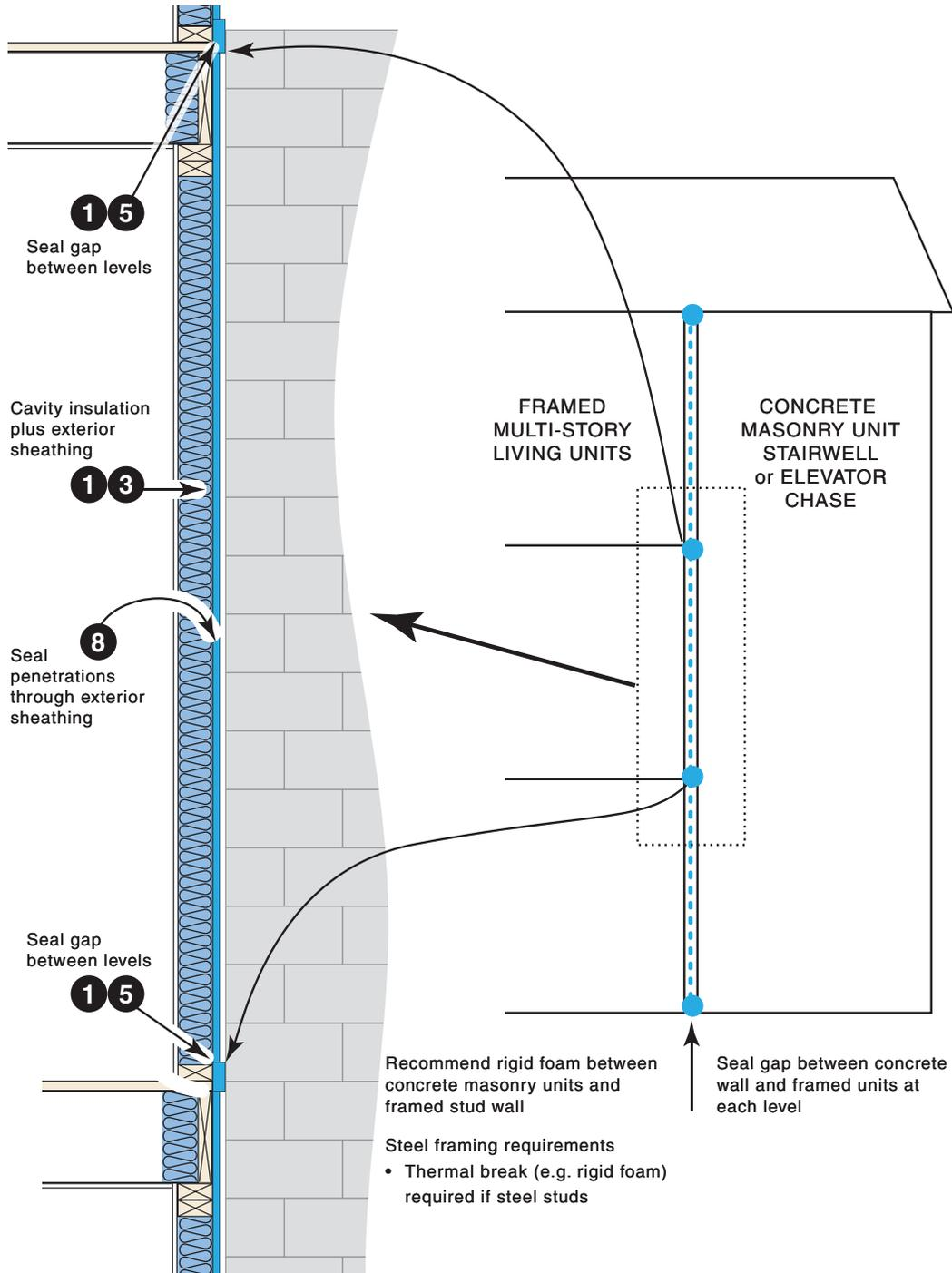

This document is intended solely to help graphically demonstrate the air leakage provisions of the 2015 IECC. It does not cover all air sealing location or techniques. Other code provisions may be applicable as well. *Image courtesy of Southface. Reprinted with permission.*



AIR SEALING KEY POINTS (continued)

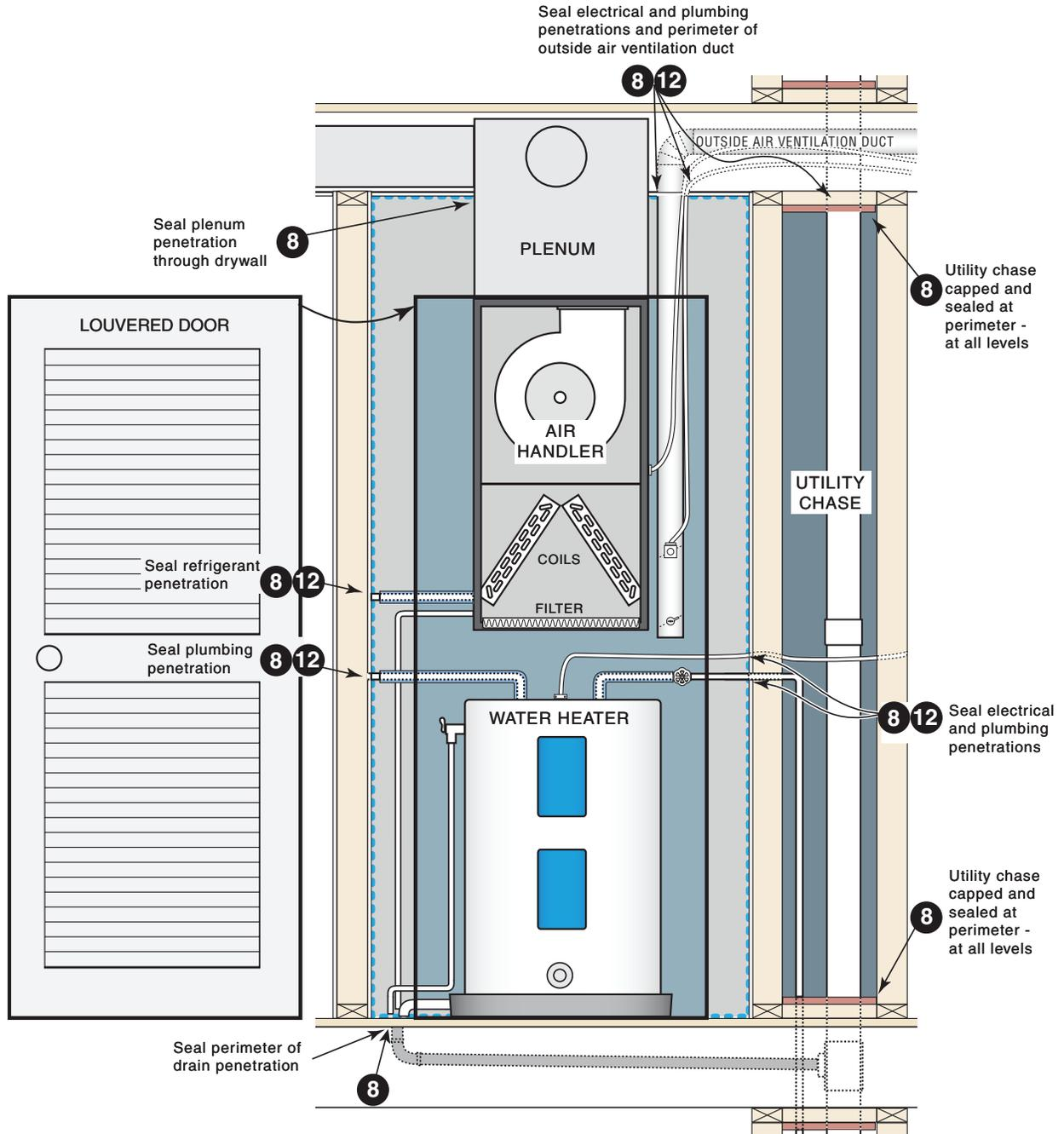

This document is intended solely to help graphically demonstrate the air leakage provisions of the 2015 IECC. It does not cover all air sealing location or techniques. Other code provisions may be applicable as well. *Image courtesy of Southface. Reprinted with permission.*



**AIR SEALING KEY POINTS (continued)**

This document is intended solely to help graphically demonstrate the air leakage provisions of section 402.4 of the 2009 IECC. It does not cover all air sealing locations or techniques. Other code provisions may be applicable as well.

**NOTE: The R-values below are from an example prepared for the state of Georgia. Iowa projects**

**Building Thermal Envelope** — The basement walls, exterior walls, floor, roof, and any other building element that enclose conditioned space. This boundary also includes the boundary between conditioned space and any exempt or unconditioned space. —2015 IECC

The *building thermal envelope* is the barrier that separates the conditioned space from the outside or unconditioned spaces. The building envelope consists of two parts - an air barrier and a thermal barrier that must be both continuous and contiguous (touching each other). In a typical residence, the building envelope consists of the roof, walls, windows, doors, and foundation. Examples of unconditioned spaces include attics, vented crawlspaces, garages, and basements with ceiling insulation and no HVAC supply registers.

Example 1 – Prescriptive Compliance

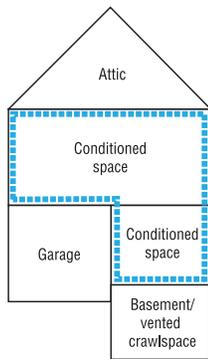

This is a conventional approach that likely locates all ductwork in unconditioned spaces.

*Prescriptive R-values*

- Flat ceiling: R-38
- Exterior walls: R-13
- Floor over garage and basement/crawl: R-19 (climate zones 3 & 4)
- Ductwork sealed with mastic and insulated to R-8 in attic, R-6 in basement/crawlspace
- Garage<sup>5</sup>, attic and basement/crawl are unconditioned spaces

Example 2 – Alternate Compliance

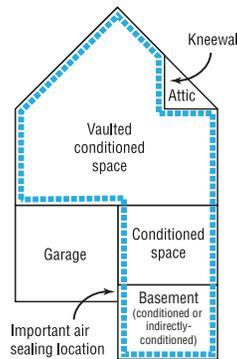

If supply registers deliver conditioned air to basement, it is considered conditioned. With no supply air, it is considered an indirectly-conditioned space.

*Example R-values<sup>1</sup>*

- Flat ceiling: R-38
- Kneewalls: R-18 (required)<sup>2</sup> (R-13+ R-5, R-15 + R-3, R-19 in 2x6)
- Vaulted ceiling: R-20 air-permeable insulation plus R-5 rigid foam board<sup>3</sup>
- Exterior walls: R-13
- Basement masonry walls: R-5
- Basement slab: R-0<sup>4</sup>
- Ductwork sealed with mastic and insulated to R-8 in attic, R-6 in basement
- Garage<sup>5</sup> and attic are unconditioned spaces

Example 3 – Alternate Compliance

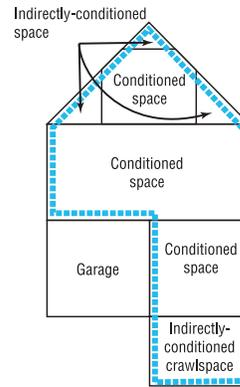

The top conditioned floor functions as a vaulted ceiling with interior walls although it appears to have kneewalls and a flat ceiling. An advantage of this approach is that all upstairs ductwork is located inside the building envelope.

The crawlspace walls are insulated and do not contain vents. The crawlspace ground is covered with 100% plastic and functions as a "mini-basement."

*Example R-values<sup>1</sup>*

- Vaulted ceiling: R-20 air-impermeable foam insulation<sup>3</sup>
- Exterior walls: R-13 + R-5 sheathing
- Crawlspace walls: R-5
- Ductwork sealed with mastic and insulated to R-6
- Garage<sup>5</sup> is unconditioned space

1 R-values shown are examples and not necessarily prescriptive code requirements. Refer to the Georgia Energy Code for specific prescriptive insulation requirements.  
 2 An attic kneewall is any vertical wall that separates conditioned space from an unconditioned attic. In Georgia, kneewalls must be insulated to R-18. A sealed attic-side air barrier (OSB, foil-faced sheathing, etc.) is required when using air permeable insulation.  
 3 Requires trade-off since prescriptive ceiling requirement is R-38, see roofline installed insulation options and section 806.4 of the 2006 IRC.  
 4 Slab insulation is not required in Georgia due to termite risk.  
 5 Although there is nothing to prevent the garage walls from being insulated, due to indoor air quality concerns, the garage should never be considered inside the building

This document is intended solely to help graphically demonstrate the air leakage provisions of the 2015 IECC. It does not cover all air sealing location or techniques. Other code provisions may be applicable as well. *Image courtesy of Southface. Reprinted with permission.*



**AIR SEALING KEY POINTS (continued)**

**Standard Truss with tapered insulation depth**

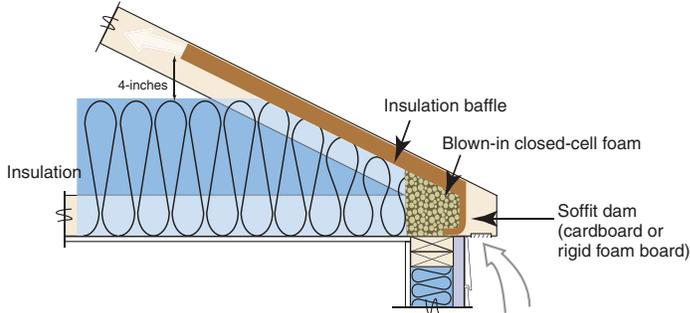

**Note: Wind wash baffle and air-permeable insulation dam.** For air permeable insulation in vented attics, baffles shall be installed adjacent to soffit and eave vents. A minimum of a 1-inch of space shall be provided between the insulation and the roof sheathing and at the location of the vent. The baffle shall extend over the top of the insulation inward until it is at least 4 inches vertically above the top of the insulation. Any solid material such as cardboard or thin insulating sheathing shall be permissible as the baffle.

**Energy Truss with full height insulation (recommended)**

**NOTE:**  
R-38 complete coverage is deemed equivalent to prescriptive R-49

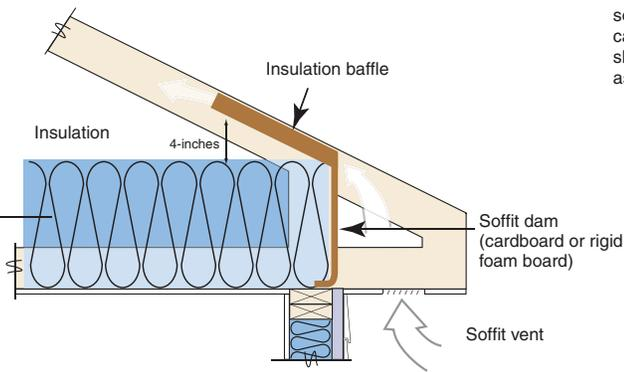

**Standard rafter and top plate with tapered insulation depth**

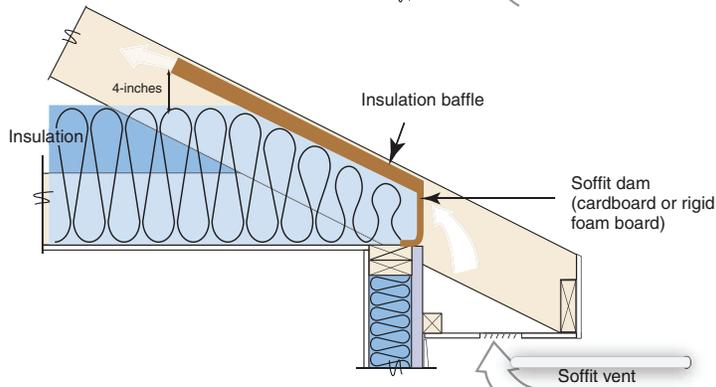

**Rafter on raised top plate with full height insulation (recommended)**

**NOTE:**  
R-38 complete coverage is deemed equivalent to prescriptive R-49

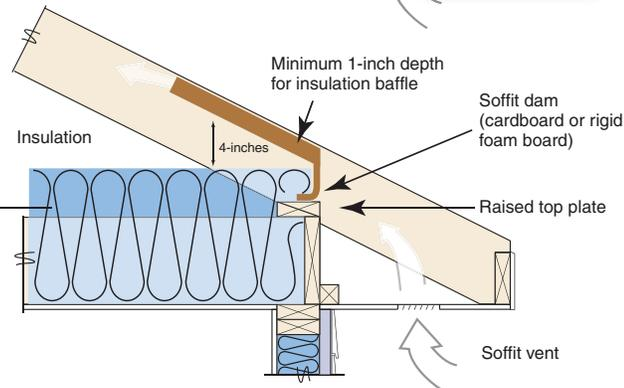

This document is intended solely to help graphically demonstrate the air leakage provisions of the 2015 IECC. It does not cover all air sealing location or techniques. Other code provisions may be applicable as well. *Image courtesy of Southface. Reprinted with permission.*



## AIR SEALING KEY POINTS (continued)

**Wall and ceiling** insulation that makes up portions of the building thermal envelope shall be installed to Passing Grade quality.

Two criteria affect installed insulation grading: **voids/ gaps** (in which no insulation is present in a portion of the overall insulated surface) and **compression/incomplete fill** (in which the insulation does not fully fill out or extend to the desired depth).

### Voids/Gaps

- Voids or gaps in the insulation are < 1% of overall component surface area (only occasional and very small gaps allowed for Passing Grade)

### Compression/Incomplete Fill

- Compression/Incomplete Fill for both *air permeable insulation* (e.g., fiberglass, cellulose) and *air impermeable insulation* (e.g., spray polyurethane foam) must be less than 1 inch in depth or less than 30% of the intended depth, whichever is more stringent. The allowable area of compression/incomplete fill must be less than 2% of the overall insulated surface to achieve a Passing Grade.
- Any compression/incomplete fill with a **depth** greater than the above specifications (up to 1" or 30% of the intended depth, whichever is more stringent) shall not achieve a Passing Grade.

### Additional Wall Insulation Requirements

- All vertical air permeable insulation shall be installed in substantial contact with an air barrier on all six (6) sides. **Exception:** Unfinished basements, rim/band joist cavity insulation and fireplaces (insulation shall be restrained to stay in place). For unfinished basements, air permeable insulation and associated framing in a framed cavity wall shall be installed less than 1/4" from the basement wall surface.
- Attic kneewall details – Attic kneewalls shall be insulated to a total R-value in Zone 5 of R-13 cavity + R-5 continuous and in Zone 6 of R-20 cavity + R-5 continuous, or R-13 in cavity + R-10 continuous insulation. Air permeable insulation shall be installed with a fully sealed attic-side air barrier (e.g., OSB with seams caulked, rigid insulation with joints taped, etc.). Attic kneewalls with air impermeable insulation shall not require an additional attic-side air barrier.

**Underfloor insulation** that makes up portions of the building thermal envelope shall be installed to Passing Grade quality.

Two criteria affect installed insulation grading: **voids/ gaps** (in which no insulation is present in a portion of the overall insulated surface) and **compression/incomplete fill** (in which the insulation does not fully fill out or extend to the desired depth).

### Voids/Gaps

- Voids or gaps in the insulation are minimal for Passing Grade (< 2% of overall component surface area)

### Compression/Incomplete Fill

- Compression/Incomplete Fill for both *air permeable insulation* (e.g., fiberglass, cellulose) and *air impermeable insulation* (e.g., spray polyurethane foam) must be less than 1 inch in depth or less than 30% of the intended depth, whichever is more stringent. The allowable area of compression/incomplete fill must be less than 10% of the overall insulated surface to achieve a Passing Grade.
- Any compression/incomplete fill with a **depth** greater than the above specifications (up to 1" or 30% of the intended depth, whichever is more stringent) shall not achieve a Passing Grade.
- Air-permeable underfloor insulation shall be permanently installed against the subfloor decking. Adequate insulation supports (e.g., wire staves) for air permeable insulation shall be installed at least every 18-24". **Exception:** The floor framing-cavity insulation shall be permitted to be in contact with the topside of sheathing or continuous insulation installed on the bottom side of floor framing where combined with insulation that meets or exceeds the minimum wood frame wall R-value and that extends from the bottom to the top of all perimeter floor framing members

This document is intended solely to help graphically demonstrate the air leakage provisions of the 2015 IECC. It does not cover all air sealing location or techniques. Other code provisions may be applicable as well. *Image courtesy of Southface. Reprinted with permission.*



AIR SEALING KEY POINTS (continued)

Voids / Gaps

*Passing Grade*

Insulation is notched and completely surrounds electrical box

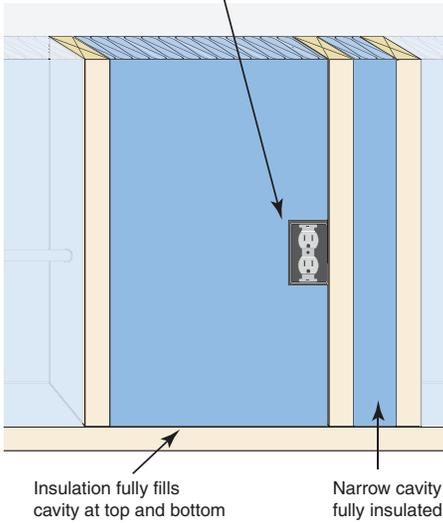

*Unacceptable Installation*

Incomplete insulation coverage around electrical box

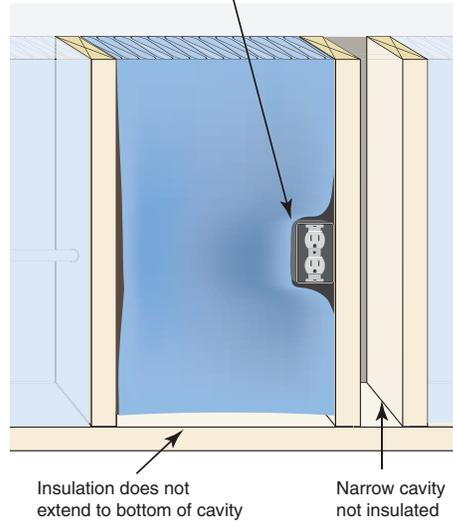

Compression / Incomplete Fill

*Passing Grade*

Insulation is slit around electrical wire

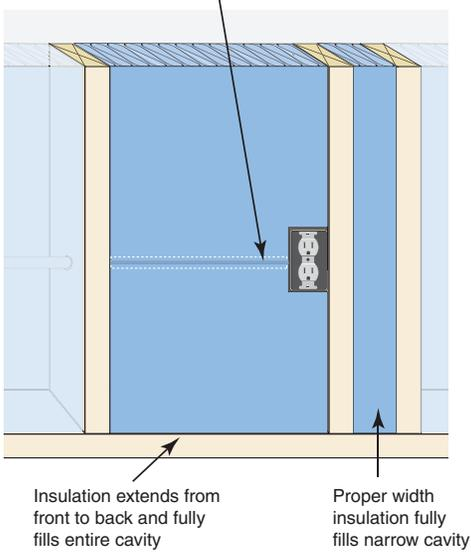

*Unacceptable Installation*

Insulation is compressed behind electrical wire

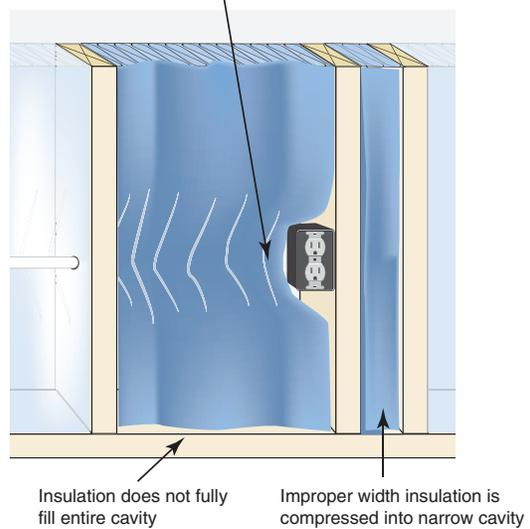

This document is intended solely to help graphically demonstrate the air leakage provisions of the 2015 IECC. It does not cover all air sealing location or techniques. Other code provisions may be applicable as well. *Image courtesy of Southface. Reprinted with permission.*



**AIR SEALING KEY POINTS (continued)**

*Passing Grade*

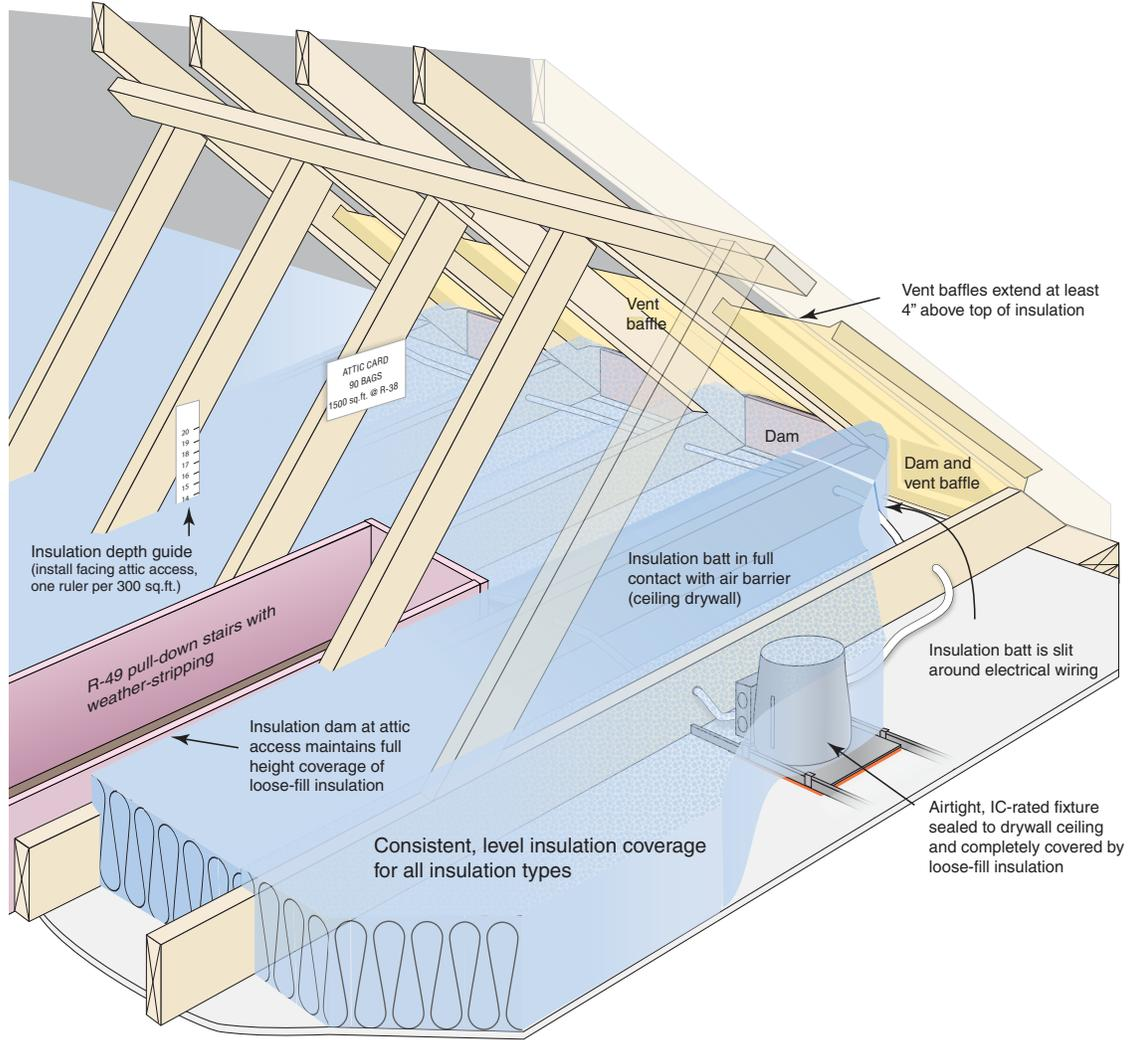

This document is intended solely to help graphically demonstrate the air leakage provisions of the 2015 IECC. It does not cover all air sealing location or techniques. Other code provisions may be applicable as well. *Image courtesy of Southface. Reprinted with permission.*



**AIR SEALING KEY POINTS (continued)**

*Passing Grade*

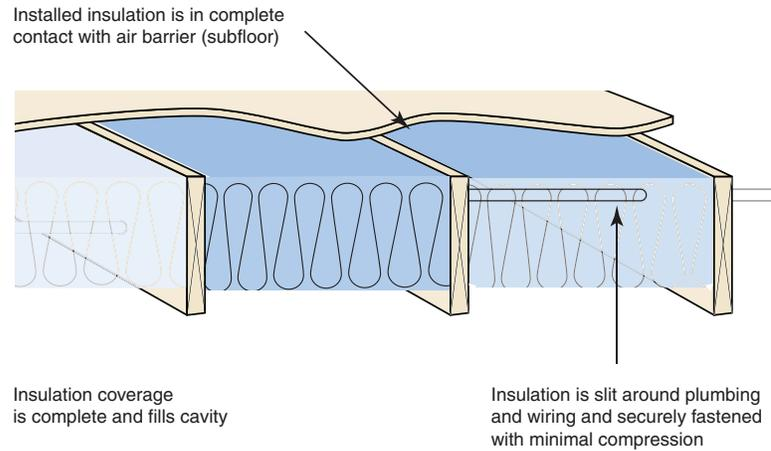

*Unacceptable Installation*

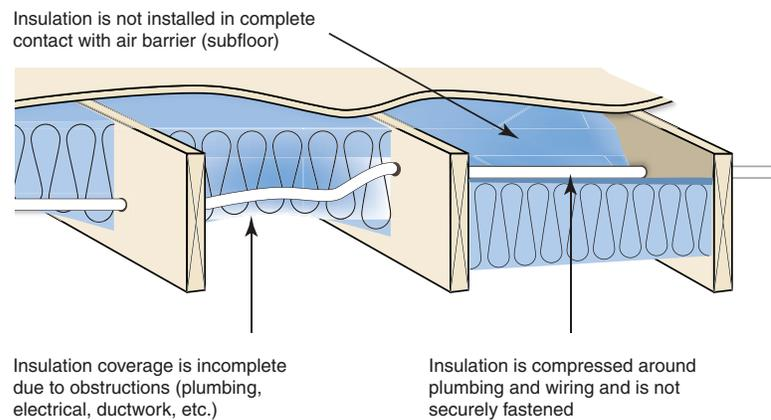

This document is intended solely to help graphically demonstrate the air leakage provisions of the 2015 IECC. It does not cover all air sealing location or techniques. Other code provisions may be applicable as well. *Image courtesy of Southface. Reprinted with permission.*



---

must use as a minimum the R-values contained in the International Energy Conservation Code 2015 for climate zones 5 and 6.

## **APPENDIX H**

# **INTEGRATED DESIGN AGENDA AND OUTCOMES TEMPLATE**

Enterprise Community Partners has developed a Green Charrette toolkit that is a tremendous resource in helping your project achieve high performance building outcomes. Provided below are an example green goals design charrette sample agenda as well as an example design charrette outcome template. For more integrated design resources, please visit [www.enterprisecommunity.org/solutions-and-innovation/green-communities/tools-and-services/charrette-toolkit](http://www.enterprisecommunity.org/solutions-and-innovation/green-communities/tools-and-services/charrette-toolkit).



## Green Communities Goal-Setting Charrette Agenda (Sample)

Project Name  
Date of Charrette

### NOTES TO FACILITATOR:

*Including this description as in introductory “one-pager” at the front end of the agenda can be helpful to those unfamiliar with charrettes. It should be noted that a primary role of the facilitator is time management, so the times indicated in this agenda are intended to assist in keeping activities on schedule. The order of this agenda can be changed, if needed, depending on the group.*

### Charrette Objectives:

1. Gain an understanding of the process required to realize Green Communities goals.
2. Establish preliminary performance goals.
3. Familiarize participants with the importance of this approach.
4. Establish next steps.

### Charrette Agenda:

Location of Charrette  
Date of Charrette  
Time of Charrette (for example: 9:00am – 5:00pm)

- 8:30 Welcome/Introductions  
a. Introduction of participants

#### NOTES TO FACILITATOR:

*Facilitator /Host will do brief welcome, then circle around the room so each individual can introduce themselves. Format will depend on number of participants, but each participant should state their name, discipline, role on project, and what they are looking to get out of the charrette / main questions they have.*

- b. Overview of the day and anticipated outcomes for the charrette

#### NOTES TO FACILITATOR:

*Facilitator will review the Agenda and format for the day’s events, including Ground Rules and Logistics (bathroom location, cell phones off, lunch/breaks, etc.). This brief overview should introduce the concept of “Co-Learning” (there are no experts) and Discovery (question assumptions) in order to set the tone for the day. Also, anticipated outcomes should be identified. This can take the form of a brief set of comments in most circumstances; for charrettes longer than one day, this can become a facilitated discussion, or a brainstorming exercise in the form of soliciting responses from attendees and recording them on flip charts.*

- 8:45 Integrative Design Overview



a. Introduction to integrative design

b. Case study examples

NOTES TO FACILITATOR:

*How this educational Power Point is presented should be adjusted to the group's level of green building knowledge, but it should focus on the integrative process as the key to producing high performance green buildings within budget; accordingly, it is important to become very familiar with the examples, concepts, and principles.*

9:45 Touchstones Exercise – alignment around goals

a. Brainstorm goals and guiding principles

b. Prioritize key issues to address, then integrate

NOTES TO FACILITATOR:

*This exercise is facilitated with the entire group. Please see the description of the Touchstones Exercise in the “Facilitators Guide”, and carefully review the “Guidance for Facilitating the Touchstones Exercise” document in order to implement this exercise accordingly.*

10:25 Break

10:40 Green Communities

a. Introduction to Green Communities Criteria & requirements

b. Case study examples

NOTES TO FACILITATOR:

*This educational Power Point presentation is intended to provide only an overview of the structure of the Green Communities Criteria. The brief presentation will be followed by a few examples of integrative strategies that address multiple criteria. This section concludes with 4 case studies that are intended to be presented very quickly, simply to reinforce that this can and has been done for dozens of projects across the country.*

11:40 Project Parameters Overview

a. Presentation of project status

b. Review of pre-charrette research and analysis

NOTES TO FACILITATOR:

*Before the Charrette, obtain from the project team a site plan to insert into the Power Point presentation (Project Parameters Overview slide) or insert a Google Earth aerial photo of the site to project on the screen while the project team presents project issues and status. This presentation should be very brief, so allow 20 minutes for the Client and design team to present their primary concerns and any specific parameters, constraints, opportunities, etc. – particularly specific site issues that the team will need to address during the breakout sessions. Be sure to remind the presenters that their presentation is to be kept brief and “to-the-point”.*

12:00 Lunch



12:45 Review Touchstones Exercise results – identify interrelationships

NOTES TO FACILITATOR:

*Again, please see the description of the Touchstones Exercise in the “Facilitators Guide”, and review the results of the Exercise as described in the “Guidance for Facilitating the Touchstones Exercise” document by identifying interrelationships accordingly.*

1:00 Breakout Group Exercise – identify potential strategies

a. Focused small group sessions to explore specific design strategies regarding:

1. Site Issues
2. Building Issues
3. Operations Issues

NOTES TO FACILITATOR:

*Exercises should take part in groups of 5-7 people, depending upon the overall group size, to allow for everyone to be involved. Try to compose the small groups with participants from a variety of backgrounds / experience in order to gain a diverse set of opinions and perspectives from each breakout team. Please see the description of the Breakout Group Exercise in the “Facilitators Guide”, and carefully review the “Guidance for Facilitating Breakout Groups” document in order to implement this exercise accordingly.*

2:15 Integrate Findings from Breakouts – alignment around strategies

- a. Report results from small group breakout sessions to larger group
- b. Identify key integrated strategies
- c. Record what to keep and what to avoid

NOTES TO FACILITATOR:

*Assuming three breakout groups, each should be given 20 minutes to present their findings and answer questions from the other participants, while the facilitator records salient points on flip charts. Then facilitate a 20-30 minute discussion on finding synergies between the 3 group's findings and record key points on flip charts. This discussion should be focused on targeting holistic solutions. Consider budget, environmental efficacy, performance goals, achievability, touchstones, and project mission. It also is helpful to generate a discussion that identifies “What to Keep” and “What to Avoid” from the small group's ideas, and again, record the results on flip charts. Be sure to have someone photograph the flip charts and any accompanying sketches, so that these can be transcribed for inclusion in a charrette report.*

3:45 Break



- 4:00 Review Green Communities Criteria  
a. Initial pass at scorecard status

NOTES TO FACILITATOR:

*The Green Communities checklist can either play a central role in the charrette or it can take a back seat to other discussions. For example, if a team is able to have a productive conversation around massing, passive design, energy, daylight, ventilation, etc. then it may make sense to NOT focus on the Checklist. In these instances, it is useful to have someone keep track of the scorecard in the background during the day, and use it as a backstop to make sure there aren't any items that are relevant for a given design phase that the team may be overlooking (e.g. mold protection). For other projects where the level of experience with green building is minimal, or the team may not be comfortable conducting holistic conversations about the building design, then the Checklist can serve as a great way to frame the conversation by simply going through each mandatory requirement and credit and allowing discussion around each criterion. In the case of a one-day charrette, use this 75-minute period to review the most critical criteria and mandatory requirements.*

- 5:15 Next Steps

NOTES TO FACILITATOR:

*Facilitate a discussion around key next steps that need to occur by identifying schedule and responsibilities for these primary tasks, and record the results on flip charts. See also the "Next Steps" section of the "Facilitators Guide".*

- 5:30 Adjourn – Post-Charrette Activity (social, happy hour, etc.)



## Design Brief Outline

*The following outline will help you work through the five major focus areas of a design brief; description of the project, developer's expectations, project vision, project size, and design considerations.*

### I. Description of the Project

Provide design teams with a basic description of the project, including:

- Name
- Site address
- Type of project (new construction, rehab, adaptive reuse, etc.)
- Size and existing condition of site
- Basic nature of surrounding community
- Anticipated basic programming of site (affordable housing, mixed use, commercial, etc.)

*The Pre-Dev Team should also include a reference map to help design team's geo-locate the project, as well as a site map so that they understand the geometries and boundary conditions of the site.*

### II. Developer's Expectations

This section is an opportunity to communicate your mission and overarching goals with teams who may not be familiar with your organization, and contextualize this project as an important component of realizing those overall goals and aspirations. Provide teams with some basic context about past development experiences, and how you see this project building upon those experiences.

### III. Project Vision

In this section, highlight your most important priorities for the project, which may include but are not limited to:

- Resident health, comfort and experience
- Durability and maintainability
- Beauty/art
- Cost effectiveness
- Sustainability and performance
- Community building
- Neighborhood impact

These are all important aspects of your project, but if too many priorities are included in this section, design teams may not get a true understanding of what is most important to you. In this section, be specific about which priorities are pivotal to making this project a success.

### IV. Project Size

Provide information about your expectations related to the size of the building, including information on number of units / bedrooms and square footage. Indicate if these are flexible or fixed, based on financing assumptions.

### V. Design Considerations

This section should provide more in-depth information related to the regulatory parameters, programming and design goals of the project. It should provide the design teams with guidance but not be proscriptive. The goal is to set a foundation upon which the design teams can be creative and innovative. Encourage design teams to be thoughtful about these parameters and identify areas where design criteria potentially conflict, and be prepared to discuss how conflicts will be negotiated.

**Zoning and Regulatory Considerations** Provide any known zoning information, such as zoning district,



available FAR, parking requirements, building type for code purposes.

Site Considerations and Neighborhood Context Provide information related to any special site or neighborhood features or considerations that should be accounted for, such as:

- Contamination
- Grading
- Desirable or undesirable adjacent parcels and building uses
- Access restrictions or requirements – pedestrian and vehicular
- Parking requirements
- Goals around activation of/use of street front
- Privacy goals
- Goals for exterior spaces and landscaping
- Neighborhood beautification goals
- Site-related maintenance goals
- Safety considerations
- Eco-districts
- Neighborhood and/or city-wide initiatives

### **Building Design Considerations**

What do you want the building to look like? What do other buildings in the neighborhood look like (height, width, location on lot, interesting features)? Is it important that this project look like the other buildings in the neighborhood, or should it stand out? In what ways?

What are some adjectives related to how you want people to feel when they pass by or walk around outside the building? What are adjectives related to how you want residents to feel when they travel through the common areas of the building?

### **Unit Design Considerations**

Provide the design team information related to your goals around unit design.

- Are there regulatory requirements for unit sizes that should be considered?
- Is unit layout flexibility important?
- What are your expectations and goals around finishes?
- Reference and include the information developed from the Project Program Guide related to your target population and their unit-based needs to complete this section.

### **Additional Program Requirements**

This section is intended to build upon the programming information in the project description sections above. Provide any relevant information developed from the Project Program Guide which was not included already, such as :

- Required space for on-site services
- Interior and exterior community- based spaces
- Operations and maintenance related spaces
- Commercial spaces

### **Greening Considerations**

It is important that expectations related to building performance are established at the RFP phase. We recommend including specific information related to the following sustainability-oriented items:

Greening Requirements – Are there regulatory and/or financing requirements related to green performance building? If so, what are they?

Utility Rebate Programs –Do you expect teams to design to standards that will enable a project to achieve efficiency rebates from relevant utility companies?



**Certifications** – Is certification under a rating system expected? Should the project be designed as “certifiable”? What rating system do you expect people to design towards (Green Communities, LEED, ENERGY STAR, Passive House, etc.)

**Renewable Energy** – Do you expect the project to include renewable energy in the base building design? If not, should the project be designed as “solar ready” should funding become available in the future?

**Systems Approach**- What level of design/system complexity is acceptable to achieve performance and sustainability? What is the capacity of your maintenance team?

**Energy Performance Goals**- Do you have specific goals around how much energy/water the building will consume? Do you have specific goals around how tightly the building is air sealed? Can you provide specific metrics related to these goals (for example, how much water the building should consume in gallons per bedroom per day)?

### **Health Considerations**

Are there specific goals related to how the building design promotes resident health?

- How important is your building design to physical activity? Indoors? Outdoors? Seasonal or all year?
- Should the design team follow any healthy living design standards, such as the Active Design Guidelines? ([centerforactivedesign.org/guidelines](http://centerforactivedesign.org/guidelines))
- What standards do you have around healthy materials selection?
- Are there environmental hazards that the building and its systems need to mitigate (air quality, radon, etc.)?

### **Universal Design Considerations**

Outline your goals and requirements related to building and site accessibility by users of varying ages and physical/mental abilities. Be sure to focus on any particular needs that the population in your building has, as well as your broader goals related to designing a building that can serve the greatest range of users possible. Be sure to include that teams are responsible for ensuring that the project design meets all local, state, and federal requirements related to accessibility.

For more information on Universal Design visit the Green Communities website:

[www.EnterpriseCommunity.org/green](http://www.EnterpriseCommunity.org/green)

### **Resilience**

What are your goals around passive survivability in the case of an emergency when power is not available? Are active backup systems required/desirable?

### **Construction Costs**

If you have expectations/requirements around the cost per square foot or per unit to construct this project, provide that information to the team. This is important in that it provides context to the design teams about what resources they will have at their disposal to achieve your goals. Ideally, teams will propose designs that achieve many, if not all, of the goals outlined above within the context of the proposed budget.



ORINOKA MILLS DESIGN BRIEF  
New Kensington Community Development Corporation  
2012 Enterprise Pre-Development Design Grant



## A. Organizational Background

### 1. Mission + Overview

New Kensington Community Development Corporation (NKCDC) is a nonprofit organization dedicated to revitalizing the Kensington, Fishtown, and Port Richmond neighborhoods in Philadelphia. NKCDC's mission is to strengthen the physical, social and economic fabric of the community by being a catalyst for sustainable development and community building.

In 2010, NKCDC initiated an extensive community engagement and master planning process to address vacancy and crime within a 23-acre study area in the heart of Kensington. The proposed plan envisions the creation of a vibrant neighborhood center that leverages the existing transit system, market opportunities, and proposed linear park network on the viaduct. This multi-phase neighborhood revitalization effort will first focus on one of the remaining structures that is part of the Orinoka Mills site located on the corner of Somerset and Ruth streets. This adaptive reuse and new construction project will transform the former industrial warehouse into affordable housing with much-needed commercial and community space. The future site will build off of the master plan and make tangible progress in restoring vitality and prosperity to the area.

Cutting through this neighborhood is the Lehigh Viaduct, which currently has only one active train line. The Viaduct isn't gated and attracts a large volume of drug and prostitution activity, which represents a significant challenge to development in this neighborhood. The heart of the study area, Kensington Ave. and Somerset St., was recently named the top drug corner in the city by the Philadelphia Weekly. Nevertheless, this neighborhood has several amenities. In addition to its close proximity to public transportation, there is a commercial corridor along the elevated train station. Businesses and community services in the area include a deli, a church and a bike shop. NKCDC aims to transform current liabilities into assets and restore the study area to vitality and prosperity.

### 2. Expectations

NKCDC envisions the redevelopment of the 60,000 sq. ft. Orinoka Mills structure and the 23 acres of vacant or dilapidated properties surrounding the building as an important opportunity for NKCDC to establish a presence and facilitate change in one of the most troubled spots in its service area. **This predevelopment design grant process will focus on the Orinoka Mills building and the adjacent land that extends to the viaduct (Phase I).**

Accordingly, architectural proposals for this project should focus on creating a vision for Phase I yet include a schematic strategy for the larger site, with implications for future phases and the surrounding area. The project should be mindful of the neighborhood context, but not mired in it. Proposals should be achievable, as well as visionary. The project should both stand alone and fit into the larger site and community.

## B. Project

### 1. Vision Statement

The Orinoka Mills redevelopment project will be a forward-looking and transformative force in the neighborhood while respecting the area's current and past character. The redevelopment will contribute to an array of services and an overall healthy community, preserving affordable housing and creating a more attractive neighborhood. Furthermore, the process and product will be accessible and transparent in nature, give hope to community members, and inspire other partners to further invest in local community development.



## 2. Description and Program

### Size

The project site is approximately one (1) acre. The site encompasses both the adjacent vacant lot and the Orinoka Mills structure, which totals approximately 60,000 sq. ft. including the basement level and the smaller adjacent timber building (please see the attached images).

### Population + Program

- Mixed-use: Low-to-moderate income 1-2 bedroom affordable housing on the upper four levels. Retail and office space on the two bottom levels, including partially submerged basement.
- Additional resident and tenant details are yet undecided.
- The project comprises the adaptive reuse of the mill building, with potential for a new construction addition.
- The design should include a rooftop program for the residents, as well as private access to the outdoors.
- The Phase I site should also include outdoor green space accessible to the surrounding community.
- Strive for 24-hour programming, ensuring “eyes on the street.”

## 3. Design Considerations (asterisks mark high priority areas)

### \*Site Integration + Connectivity

- Consider how the site and building relate to the surrounding neighborhood.
- The site should incorporate Transit-Oriented-Development strategies, considering the proximity of and connection to the El.
- The building should be open and accessible to the community, with a public relationship with the street.
- Strategies for Ruth Street, particularly as a less intimidating thoroughway.
- Include at least two entrances for residential and public programming.
- Include streetscape considerations along Ruth and Somerset.

### \*Safety Concerns

- Prioritize crime prevention (i.e. secure entryways) but do not propose a fortress.
- Avoid undefined common spaces and maintain defensible space (again, “eyes on the street”).
- Create an intentional environment, with well-considered streetscapes and maintained buildings that discourage illicit activity. Consider improved pavement, exterior lighting, etc. conditions to create a welcome gateway, particularly on the path to the transit hub.
- Acknowledge the area’s crime and drug issues but do not let them drive the design. What is your approach to this? Have you done any similar work in similar conditions?

### \*Sustainability + Health

- The development will strive for LEED Gold or Platinum.
- Landscaping and building design should account for stormwater management, particularly for viaduct runoff.
- Salvage as much material as possible from the existing building.
- Prioritize safe and healthy materials to maintain high indoor air quality.
- Operable windows and ceiling fans.
- Transit-oriented-development and bicycle connectivity.
- Note: There is likely necessary remediation associated for outdoor open spaces.

### Community + Open Space

- Include an outdoor green space accessible to the surrounding community.
- Consider urban agriculture and artwork on site.
- Create a balance between private and public open space, including an accessible roof that celebrates the view.
- Propose a strategy for how open space will play out on the larger site in future phases.

***Accessibility, Zoning + Maintenance***

- All spaces must be ADA accessible.
- Propose a secondary means of egress as the previous staircase was demolished.
- Maintain material durability for longer lifespan and lower costs.

***Design Identity:***

- Respect (but do not replicate) the historic character of the building and site. The community development team values the natural light and valuable historic character of the existing building.
- Reduce space dedicated to cars, minimize surface parking, and promote alternative transportation.
- The project is neither institutional looking nor fortress-like. It should be secure and deter crime.
- Include access to the outdoors and green space, either private (balcony) or communal (rooftop). Also consider green space open to the larger community.
- Develop a strategy in relation to the neighboring building, which may or may not also be renovated.



## NEW KENSINGTON'S ORINOKA MILLS: PRE-DEVELOPMENT DESIGN VISIONING ARCHITECT INVITATION

Neighborhood Context: Aerial photograph of the study site (outlined in red)



Site Detail: Aerial photograph of the Orinoka Mills site (outlined in yellow)





## APPENDIX I

# STORMWATER MANAGEMENT MILESTONE CHECKLIST FOR IEDA FUNDED PROJECTS

Recipient Name \_\_\_\_\_

IEDA Contract Number \_\_\_\_\_

Technical Advisor \_\_\_\_\_

1. Project initiation meeting held (date) \_\_\_\_\_
2. Design concept sent to technical advisor (date) \_\_\_\_\_
  - Design concept approved by technical advisor (date) \_\_\_\_\_
3. 30% plans and specifications sent to technical advisor (date) \_\_\_\_\_
  - 30% plans and specifications approved by technical advisor (date) \_\_\_\_\_
4. 60% plans, specifications, and design review checklists sent to technical advisor
  - 60% plans, specifications, and design review checklists approved by technical advisor (date) \_\_\_\_\_
5. 90% plans and specifications sent to technical advisor (date) \_\_\_\_\_
  - 90% plans and specifications approved by technical advisor (date) \_\_\_\_\_
6. Maintenance plan prepared and submitted to grant applicant and technical advisor (date) \_\_\_\_\_
  - Maintenance plan approved by technical advisor (date) \_\_\_\_\_
  - Maintenance plan approved by grant applicant (date) \_\_\_\_\_
7. Final plans, design review checklists, and specifications sent to technical advisor (date) \_\_\_\_\_
  - Final plans, specifications, and design review checklists approved by technical advisor (date) \_\_\_\_\_ (signature) \_\_\_\_\_
8. Pre-construction meeting scheduled and technical advisor invited (date) \_\_\_\_\_
9. Interim inspections scheduled with the technical advisor
  - Stage \_\_\_\_\_ Date \_\_\_\_\_
  - Stage \_\_\_\_\_ Date \_\_\_\_\_
  - Stage \_\_\_\_\_ Date \_\_\_\_\_
  - Stage \_\_\_\_\_ Date \_\_\_\_\_
10. Final inspection scheduled with grant applicant, design consultant, and technical advisor.  
(date) \_\_\_\_\_
11. Project Certified as Complete (date) \_\_\_\_\_ (signature) \_\_\_\_\_
12. Ensure outreach goals (if applicable) have been met from the initial application (date) \_\_\_\_\_



## APPENDIX J

### GLOSSARY

Websites listed were last accessed December 9, 2014. Please note that some of the links below may require subscriptions to access content.

**Active Design:** An approach to the development of buildings, streets and neighborhoods that uses architecture and urban planning to make daily physical activity and healthy foods more accessible and inviting.

**Adaptive plant species:** A non-native plant species that performs similarly to a native species in a particular region, state, ecosystem and habitat, and that 1) can survive temperature / weather extremes in the microclimate; 2) requires little irrigation or fertilization, once established; 3) is resistant to local pests and diseases; and 4) does not displace other plants, as invasives do.

**Adaptive reuse building:** An existing building that is being renovated to accommodate a new use, e.g., rehabilitating an old school for use as housing.

**Air barrier:** Air barriers are systems of materials designed and constructed to control airflow between a conditioned space and an unconditioned space. The air barrier system is the primary air enclosure boundary that separates indoor (conditioned) air and outdoor (unconditioned) air. In multi-unit /townhouse / apartment construction, the air barrier system also separates the conditioned air from any given unit and adjacent units. [www.buildingscience.com/documents/digests/bsd-104-understanding-air-barriers](http://www.buildingscience.com/documents/digests/bsd-104-understanding-air-barriers)

**ASHRAE (American Society of Heating, Refrigerating and Air-Conditioning Engineers) Standard 62.1 and 62.2-2016:** ANSI/ASHRAE Standards 62.1 and 62.2 are the recognized standards for ventilation system design and acceptable IAQ. [www.ashrae.org/standards-research--technology](http://www.ashrae.org/standards-research--technology)

**ASHRAE Standard 90.1:** Provides the minimum requirements for energy-efficient design of most buildings, except low-rise residential buildings. It offers, in detail, the minimum energy-efficient requirements for design and construction of new buildings and their systems, new portions of buildings and their systems, and new systems and equipment in existing buildings, as well as criteria for determining compliance with these requirements.

**Berm:** A sloped wall or embankment, typically constructed of earth, hay bales or timber framing, used to prevent inflow or outflow of material into or out of an area. [www.epa.gov/OUST/pubs/tum\\_appx.pdf](http://www.epa.gov/OUST/pubs/tum_appx.pdf)

**Building Performance Institute (BPI):** A national standards development and credentialing organization for residential energy-efficiency retrofit work that provides training through a network of affiliate organizations, individual certifications, company accreditations and quality assurance programs.

**California 01350:** A Special Environmental Requirements standard specification developed by the state of California to cover key environmental performance and public health considerations for building projects. Contains guidelines for energy, materials, water efficiency, indoor air quality (IAQ), nontoxic performance standards for cleaning and maintenance products, and sustainable site planning and landscaping considerations, among other measures. [www.calrecycle.ca.gov/greenbuilding/specs/section01350](http://www.calrecycle.ca.gov/greenbuilding/specs/section01350)

**CFM (cubic feet per minute):** A standard unit of measurement for airflow that indicates how many cubic feet of air are passing through a fixed point per minute.



**Charrette:** An intense work session that brings together a diverse group of housing professionals as well as funders, policymakers, health practitioners and community stakeholders to integrate sustainable green design principles into affordable housing developments before schematic designs are complete. A charrette sets the stage for a clear vision of project goals and individual responsibilities, but not necessarily final design decisions. [www.enterprisecommunity.org/solutions-and-innovation/green-communities/tools-and-services/charrette-toolkit](http://www.enterprisecommunity.org/solutions-and-innovation/green-communities/tools-and-services/charrette-toolkit)

**Common area:** An area available for use by more than one person, including rental or sales offices, entrances, hallways, shared activity or leisure rooms, resident services areas, and laundry rooms.

**CSA (Community-Supported Agriculture):** A community of individuals who pledge support to a farm operation so that the farmland becomes the community's farm, with the growers and consumers providing mutual support and sharing the risks and benefits of food production. Typically, members of the farm or garden pledge in advance to cover the anticipated costs of the farm operation and the farmer's salary. In return, they receive shares in the farm's bounty throughout the growing season. Members also share in the risks of farming, including poor harvests due to unfavorable weather or pests. [www.nal.usda.gov/afsic/pubs/csa/csadef.shtml](http://www.nal.usda.gov/afsic/pubs/csa/csadef.shtml)

**Compost blanket:** A layer of loosely applied compost or composted material that is placed on the soil in disturbed areas to control erosion and retain sediment resulting from sheet-flow runoff. [www.epa.gov/large-scale-residential-demolition/managing-stormwater-and-dust-demolition-sites](http://www.epa.gov/large-scale-residential-demolition/managing-stormwater-and-dust-demolition-sites)

**CO (carbon monoxide):** A colorless, odorless and tasteless gas that greatly affects indoor air quality. Because it is impossible to see, taste or smell the toxic fumes, CO can kill you before you are aware that it is in your home. At lower levels of exposure, CO causes mild effects that are often mistaken for the flu. These symptoms include headaches, dizziness, disorientation, nausea and fatigue. [www.epa.gov/indoor-air-quality-iaq/carbon-monoxides-impact-indoor-air-quality](http://www.epa.gov/indoor-air-quality-iaq/carbon-monoxides-impact-indoor-air-quality)

**Dial-a-ride program:** A privately or publicly operated program that provides an on-demand ride service, requiring passengers to call ahead to reserve a ride. These programs usually provide connections between different transportation systems and/or employment centers.

**Distribution uniformity:** A measure of the evenness of irrigation water coverage over a defined area. [www.epa.gov/sites/production/files/2017-01/documents/ws-homes-irr-audit-guidelines.pdf](http://www.epa.gov/sites/production/files/2017-01/documents/ws-homes-irr-audit-guidelines.pdf)

**Dwelling unit:** A single unit providing the complete independent living facilities for one or more people, including permanent provisions for living, sleeping, eating, cooking and sanitation. From Addendum J to ASHRAE 62.2-2010, found online at: [www.ashrae.org/standards-research--technology/standards-addenda](http://www.ashrae.org/standards-research--technology/standards-addenda)

**ECM (electronically commutated motor):** Also known as brushless DC motors, ECMs are synchronous motors that are powered by a DC electric source via an integrated inverter/switching power supply that produces an AC electric signal. Used, for example, in HVAC equipment that uses electricity efficiently, particularly at lower speeds.

**Emissivity:** A unitless measure describing the relative ability of a surface to emit radiation energy ranging from 0.00 (minimum radiation of heat) to 1.00 (maximum radiation of heat). More reflective materials have a lower emissivity.



**Employer vanpool:** A program in which 5 to 15 people (over the age of 16) ride together to and from work. The vanpool may be public or private, but must carry all passengers more than half the distance to work to qualify. Vanpools may be employer-operated, sponsored by transit agencies, or administered by third-party operators.

**ENERGY STAR:** A voluntary labeling program designed to identify and promote energy-efficient products to reduce greenhouse gas emissions. Introduced by the EPA in 1992, ENERGY STAR also offers an accepted national standard for certifying new residential construction projects. [www.energystar.gov](http://www.energystar.gov)

**Engineered wood products:** Wood building materials manufactured by gluing particles, fibers or veneers to increase strength. For the purposes of Criterion 6.5 Certified, Salvaged and Engineered Wood Products, Green Communities considers prefabricated and precut wood products as “engineered wood products.” [www.astm.org/SNEWS/JUNE\\_2003/yeh\\_jun03.html](http://www.astm.org/SNEWS/JUNE_2003/yeh_jun03.html)

**Entryway:** Threshold separating the indoor space from the outdoor space.

**Environmental site assessment:** An investigation of the site’s conditions often performed before acquisition of a property to satisfy the due-diligence requirements of a property transaction.

**Erosion blankets or geotextile mats:** Porous fabrics used for a variety of purposes, including separators, reinforcement, filtration and drainage, and erosion control. [www.epa.gov/large-scale-residential-demolition/managing-stormwater-and-dust-demolition-sites](http://www.epa.gov/large-scale-residential-demolition/managing-stormwater-and-dust-demolition-sites)

**Filter sock:** A mesh tube filled with composted material that is placed perpendicular to sheet-flow runoff to control erosion and retain sediment in disturbed areas. [www.epa.gov/large-scale-residential-demolition/managing-stormwater-and-dust-demolition-sites](http://www.epa.gov/large-scale-residential-demolition/managing-stormwater-and-dust-demolition-sites)

**Formaldehyde:** A chemical used widely by industry to manufacture building materials and numerous household products. Formaldehyde is also a byproduct of combustion and certain other natural processes, and thus may be present in substantial concentrations both indoors and outdoors. Health effects include eye, nose and throat irritation; wheezing and coughing; fatigue; skin rash; and severe allergic reactions. High levels of exposure may cause some types of cancer. [www.epa.gov/iaq/formaldehyde.html](http://www.epa.gov/iaq/formaldehyde.html)

**Slab:** One type of foundation, with many variations (monolithic slabs, floating slabs, rat slabs, in conjunction with a basement, etc.), that may be above, at or below grade. Wood frame crawl foundations are an alternative to slabs.

**Greenfield:** A previously undeveloped parcel of land.

**Green roof:** A planted roof that reduces stormwater runoff. [www.epa.gov/soakuptherain/soak-rain-green-roofs](http://www.epa.gov/soakuptherain/soak-rain-green-roofs)

**Greywater:** Wastewater produced from baths and showers, clothes washers and lavatories. Greywater gets its name from its cloudy appearance and from its status as being neither fresh (as in potable water) nor heavily contaminated (as in blackwater from toilet waste). [greywateraction.org/greywater-reuse](http://greywateraction.org/greywater-reuse)



**HERS Index (Home Energy Rating System Index):** A scoring system established by the Residential Energy Services Network (RESNET) in which a home built to the specifications of the HERS Reference Home (based on the 2006 International Energy Conservation Code) achieves a HERS Index score of 100, while a net zero energy home achieves a HERS Index score of 0. The lower a home's HERS Index score, the more energy-efficient it is in comparison to the HERS Reference Home. Each 1-point decrease in the HERS Index score corresponds to a 1% reduction in energy consumption compared to the HERS Reference Home; thus, a home with a HERS Index score of 85 is 15% more energy-efficient than the HERS Reference Home, and a home with a HERS Index score of 80 is 20% more energy-efficient.

**Health Impact Assessment (HIA):** A systematic process that uses an array of data sources and analytic methods and considers input from stakeholders to determine the potential effects of a proposed policy, plan, program or project on the health of a population and the distribution of those effects within the population. An HIA provides recommendations on monitoring and managing those effects.

[www.pewtrusts.org/en/projects/health-impact-project/health-impact-assessment](http://www.pewtrusts.org/en/projects/health-impact-project/health-impact-assessment)

**Home Energy Rating:** An analysis of a home's construction through plans and on-site inspections. Based on the home's plans, the Home Energy Rater uses an energy-efficiency software package to perform an energy analysis of the home's design. This analysis yields a projected, pre-construction HERS Index. Upon completion of the plan review, the rater will work with the builder to identify the energy-efficiency improvements needed to ensure that the house will meet ENERGY STAR performance guidelines. The rater then conducts on-site inspections, typically including a blower door test (to test the tightness of the dwelling unit envelope) and a duct leakage test (to test the tightness of the ducts). Results of these tests, along with inputs derived from the plan review, are used to generate the HERS Index score for the home.

**IECC (International Energy Conservation Code):** A model building energy code created by the International Code Council to set a minimum standard for energy efficiency; updated on a three-year schedule.

[www.iccsafe.org](http://www.iccsafe.org)

**Infill site:** A site with 75% of its perimeter bordering existing development or roads and with access to existing infrastructure.

**Integrative design:** A design approach that brings together at an early stage in project planning all the members of the building stakeholder community, and the technical planning, design and construction team (including green building consultants such as the green rater, mechanical engineer /energy expert and others) to look at the project objectives, building materials, systems and assemblies from many different perspectives. This approach is a deviation from the typical planning and design process of relying on the expertise of specialists who work in their respective specialties somewhat isolated from each other.

[www.enterprisecommunity.org/solutions-and-innovation/green-communities/tools-and-services/charrette-toolkit](http://www.enterprisecommunity.org/solutions-and-innovation/green-communities/tools-and-services/charrette-toolkit)

**Intermittent rate:** Ventilation that stops and starts at regular intervals (i.e., the opposite of continuous ventilation).

**LED (light-emitting diode):** Energy-efficient light technologies that produce less initial heat per lumen, consume less energy, and last longer than conventional incandescent and fluorescent lights.

**Low-impact development:** A strategy of site design where the goal is to restore the natural, pre-developed ability of an urban site to absorb stormwater. [www.epa.gov/nps/urban-runoff-low-impact-development](http://www.epa.gov/nps/urban-runoff-low-impact-development)



**Maintained solar reflectance:** A measure of a material's ability to maintain its initially rated solar reflectance. Products are tested over a period of three years.

**Manual D:** Manual prepared by the Air Conditioning Contractors of America (ACCA) on designing residential duct systems. [www.acca.org/technical-manual/manual-d](http://www.acca.org/technical-manual/manual-d)

**Manual J:** Manual prepared by ACCA on determining heating and cooling loads of residential structures. [www.acca.org/technical-manual/manual-j](http://www.acca.org/technical-manual/manual-j)

**Manual S:** Manual prepared by ACCA on selecting residential heating and cooling equipment to match the heating and cooling loads of residential structures. [www.acca.org/technical-manual/manual-s](http://www.acca.org/technical-manual/manual-s)

**Moderate rehabilitation:** A project that does not fully expose the structure and envelope of the building and/or does not include replacement or improvement of two or more major systems of the building, yet is still able to comply with the energy performance requirements of at least one iteration of Criterion 5.1.

**Native plant species:** A plant species that occurs naturally in a particular region, state, ecosystem and habitat without direct or indirect human actions. [iowanativeplants.org/links.php](http://iowanativeplants.org/links.php) and [secure.iowadot.gov/lrtf/NativePlantPublic.aspx](http://secure.iowadot.gov/lrtf/NativePlantPublic.aspx)

**Naturescaping:** A method of landscaping that reduces water use, energy consumption and chemical needs by using climate-appropriate plants and maintenance techniques.

**Non-buildable land:** Land that is not economically feasible to be developed, such as easements, utility fall zones, unsuitable soil, steep grades, water features, wetlands or natural preserves.

**Open space:** Undeveloped land that is permanently set aside for public use. Open space may be used as community open space or preserved as green space, and includes parcels in conservation easement or land trust, park or recreation areas, and community gardens.

**Permeable paving:** A porous cover system that encourages groundwater recharge and infiltration. [www.rainscapingiowa.org/documents/filelibrary/permeable\\_pavement\\_systems/PermPavemtBrochure\\_1CDC21254C1A6.pdf](http://www.rainscapingiowa.org/documents/filelibrary/permeable_pavement_systems/PermPavemtBrochure_1CDC21254C1A6.pdf) and [www.iowadnr.gov/Environmental-Protection/Water-Quality/NPDES-Storm-Water/Storm-Water-Manual](http://www.iowadnr.gov/Environmental-Protection/Water-Quality/NPDES-Storm-Water/Storm-Water-Manual)

**Phenol-formaldehyde:** A resin used in the manufacture of composite wood products primarily for outdoor use, including softwood plywood and flake or oriented strand board. Composite wood products that contain phenol-formaldehyde generally emit formaldehyde at lower rates than those containing urea formaldehyde resin. [www.epa.gov/iaq/formaldehyde.html](http://www.epa.gov/iaq/formaldehyde.html)

**Photocell:** A light-sensitive device that detects ambient light and controls exterior fixtures accordingly.

**Photovoltaics:** Composite materials that convert sunlight directly into electrical power.

**Post-consumer waste:** Materials or finished products that have served their intended use and so have been diverted or recovered from waste destined for disposal.

**Post-industrial waste (also called pre-consumer waste):** Materials generated in manufacturing and converting processes such as manufacturing scrap and trimmings and cuttings.

**Public-private regional transportation:** Private company offering public transit services through a public



funding stream, based on a regular schedule and permanent stops.

**Radon:** A colorless, odorless and tasteless gas that greatly affects indoor air quality. According to the EPA, radon exposure is the second leading cause of lung cancer in the United States. [idph.iowa.gov/radon](http://idph.iowa.gov/radon)

**Recessed light fixture (recessed can):** A luminaire that is installed into an opening in the ceiling or wall.

**Resilience:** The capacity to adapt to changing conditions and to maintain or regain functionality and vitality in the face of stress or disturbance. Relative to climate change, resilience involves adaptation to the wide range of regional and localized impacts that are expected with a warming planet: more intense storms, greater precipitation, coastal and valley flooding, longer and more severe droughts in some areas, wildfires, melting permafrost, warmer temperatures, and power outages. [www.resilientdesign.org](http://www.resilientdesign.org)

**Resilient flooring:** Flooring products in which the wearing surface is non-textile, including but not limited to rubber, polymeric and linoleum. [www.nsf.org/services/by-industry/sustainability-environment/sustainability-standards-protocols/floor-coverings](http://www.nsf.org/services/by-industry/sustainability-environment/sustainability-standards-protocols/floor-coverings)

**RESNET (Residential Energy Services Network):** A national not-for-profit membership corporation that is a recognized standards-making body for building energy-efficiency rating and certification systems in the United States. [www.resnet.us](http://www.resnet.us)

**Retention basin:** A shallow impoundment, sometimes referred to as a “wet detention pond,” designed to capture and retain stormwater runoff during storm events. [www.iowadnr.gov/Environmental-Protection/Water-Quality/NPDES-Storm-Water/Storm-Water-Manual](http://www.iowadnr.gov/Environmental-Protection/Water-Quality/NPDES-Storm-Water/Storm-Water-Manual)

**Road section:** The cross-section through a street, with particular attention paid to the width of the street and its hydrology. Carefully planned road sections can decrease the amount of impervious surfaces and improve the overall stormwater management for the project site. More information can be found in the document “Low-Impact Development Design Strategies: An Integrated Design Approach,” found at [www.lid-stormwater.net](http://www.lid-stormwater.net)

**Rock filter (or filter berm):** A permanent or temporary stone structure installed to serve as a sediment-filtering device in drainage ways. Allows a pool to form in an excavated or natural depression, where sediment can settle. The pool is then dewatered through the gravel rock dam. [www.epa.gov/large-scale-residential-demolition/managing-stormwater-and-dust-demolition-sites](http://www.epa.gov/large-scale-residential-demolition/managing-stormwater-and-dust-demolition-sites)

**Silt fencing:** A temporary fabric barrier surrounding a site to control stormwater runoff. [www.epa.gov/large-scale-residential-demolition/managing-stormwater-and-dust-demolition-sites](http://www.epa.gov/large-scale-residential-demolition/managing-stormwater-and-dust-demolition-sites)

**Silt sacks:** Tube-shaped erosion-control devices. [www.epa.gov/large-scale-residential-demolition/managing-stormwater-and-dust-demolition-sites](http://www.epa.gov/large-scale-residential-demolition/managing-stormwater-and-dust-demolition-sites)

**Solar hot water system:** Captures, converts and transfers heat from direct and indirect sunlight to heat an auxiliary water tank and provide hot water for a building’s occupants.

**Solar reflectance (or albedo):** A measure of a material’s ability to reflect sunlight (including the visible, infrared and ultraviolet wavelengths) on a scale of 0 to 1. A solar reflectance value of 0.0 indicates that the surface absorbs all solar radiation, and a 1.0 solar reflectance value represents total reflectivity.

**Solar south:** A measurement of the sun’s true position based on its path across the sky. It is different from magnetic south, which is taken from a compass reading. Methods for calculating solar south include the solar noon method or a compass using a magnetic declination chart to correct for magnetic declination.



Static service pressure: The pipeline or municipal water supply pressure when water is not flowing.

**Straw bale:** A bound block of straw and organic material used to control stormwater runoff.

[www.epa.gov/large-scale-residential-demolition/managing-stormwater-and-dust-demolition-sites](http://www.epa.gov/large-scale-residential-demolition/managing-stormwater-and-dust-demolition-sites)

**Substantial rehabilitation:** A project that includes the replacement and/or improvement of at least two major systems of the building, including its envelope. Major building systems include roof structures, wall or floor structures, foundations, plumbing, heating and air conditioning, and electrical systems. The building envelope is defined as the air barrier and thermal barrier separating exterior from interior space.

**Supportive housing dwelling units:** Permanent housing with attached intensive services targeted to populations that have special needs, including people who are currently or formerly homeless; those with serious, chronic mental health issues; people in various stages of recovery from substance abuse; people with HIV/AIDS, or physical or developmental disabilities; the formerly incarcerated, the frail elderly, homeless or emancipated youth, and victims of domestic violence; and other groups that would not be able to live independently and maintain housing without intensive support.

**Swales:** Shallow grass-covered hydraulic conveyance channels that help to slow runoff and facilitate infiltration.

[www.iowadnr.gov/Environmental-Protection/Water-Quality/NPDES-Storm-Water/Storm-Water-Manual](http://www.iowadnr.gov/Environmental-Protection/Water-Quality/NPDES-Storm-Water/Storm-Water-Manual)

**Tiers:** Earthen embankments that reduce erosion by slowing, collecting and redistributing surface runoff to stable outlets that increase the distance of overland runoff flow.

**Transit ride:** A scheduled stop along a defined route of one form of public transportation (bus, rail or ferry).

**Universal Design:** The design of products and environments to be usable by all people, to the greatest extent possible, without the need for adaptation or specialized design. The principles of Universal Design are as follows: 1) equitable use, 2) flexibility in use, 3) simple and intuitive use, 4) perceptible information, 5) tolerance for error, 6) low physical effort and 7) size and space for approach and use.

[www.ncsu.edu/ncsu/design/cud/about\\_ud/udprinciplestext.htm](http://www.ncsu.edu/ncsu/design/cud/about_ud/udprinciplestext.htm)

**Urea-formaldehyde:** A toxic resin created from formaldehyde that causes similar side effects. Composite wood products made for indoor use, such as particleboard, hardwood plywood paneling and medium-density fiberboard, often contain this resin. [www.epa.gov/formaldehyde](http://www.epa.gov/formaldehyde)

**Vapor retarder:** The International Residential Code (IRC) defines vapor retarders as Class I, II or III based on how permeable they are to water vapor — the lower the permeability, the less water vapor that will pass through the vapor retarder.

*Class I:* Very low permeability vapor retarders — rated at 0.1 perms or less. Sheet polyethylene (visqueen) or unperforated aluminum foil (FSK) are Class I vapor retarders.

*Class II:* Low permeability vapor retarders — rated greater than 0.1 perms and less than or equal to 1.0 perms. The kraft facing on batts qualifies as a Class II vapor retarder.

*Class III:* Medium permeability vapor retarders — rated greater than 1.0 perms and less than or equal to 10 perms. Latex and enamel paint qualify as Class III vapor retarders.

For additional information, visit NAIMA at:

[www.naima.org/insulation-knowledge-base/residential-home-insulation/insulation-and-vapor-retarders.html](http://www.naima.org/insulation-knowledge-base/residential-home-insulation/insulation-and-vapor-retarders.html)



**Vehicle share program:** A private system in which a company or a group of individuals share vehicles on a reservation basis and pay for the use on the basis of time or mileage. Programs that qualify under Criterion 2.7 Access to Public Transportation must have an established formal agreement among participants.

**Ventilation:** The process of supplying outdoor air to, or removing air from, a dwelling by natural or mechanical means. Such air may or may not have been conditioned.

**VOCs (volatile organic compounds):** A large group of carbon-based chemicals that easily evaporate at room temperature. [www.epa.gov/indoor-air-quality-iaq/technical-overview-volatile-organic-compounds](http://www.epa.gov/indoor-air-quality-iaq/technical-overview-volatile-organic-compounds)

**Walk distance:** The distance a pedestrian must travel between origins and destinations without obstruction, in a safe and comfortable environment on a continuous network of sidewalks, all-weather-surface footpaths, crosswalks or equivalent pedestrian facilities. Any crossing of a street with speeds at or greater than 30 miles per hour requires controlled crossing (e.g., a stop sign or stop light).

**Water factor:** The quotient of the total weighted per-cycle water consumption divided by the capacity of the clothes washer. Lower numbers indicate more efficient use of water.

**Watershed:** The area of land where all of the water that is under it or drains off of it goes into the same place. [www.epa.gov/hwp/basic-information-and-answers-frequent-questions](http://www.epa.gov/hwp/basic-information-and-answers-frequent-questions)

**Weather-based irrigation controller (WBIC):** An automated “thermostat for your sprinkler system” that operates your irrigation system based on local weather, landscape conditions and plant watering needs. Weekend ride options: A public transit option of either bus, rail or ferry service. Employer-assisted vanpools and dial-a-ride programs are examples of qualifying weekend service.

**Well-being:** Well-being includes the presence of positive emotions and moods (e.g., contentment, happiness), the absence of negative emotions (e.g., depression, anxiety), satisfaction with life, fulfillment and positive functioning. In simple terms, well-being can be described as judging life positively and feeling good.

**Xeriscaping:** A method of landscaping aimed at reducing or eliminating excess water from irrigation by using drought-tolerant plants. [www.landscapingnetwork.com/landscape-design/Xeriscape.html](http://www.landscapingnetwork.com/landscape-design/Xeriscape.html)



Iowa Economic Development Authority  
1963 Bell Avenue, Suite 200  
Des Moines, Iowa 50309

515.348.6200

[iowaeconomicdevelopment.com](http://iowaeconomicdevelopment.com)